

ML240 Series

■ Thermal Transfer ■ Direct Thermal
Industrial Barcode Printers



Series Lists:

ML240/ML340

ML240P/ML340P

User Manual

Copyright Information

©2021 TSC Auto ID Technology Co., Ltd.

The copyright in this manual, the software and firmware in the printer described are owned by TSC Auto ID Technology Co., Ltd. All rights reserved.

CG Triumvirate is a trademark of Agfa Corporation. CG Triumvirate Bold Condensed font is under license from the Monotype Corporation. Windows is a registered trademark of Microsoft Corporation.

All other trademarks are the property of their respective owners. Information in this document is subject to change without notice and does not represent a commitment on the part of TSC Auto ID Technology Co. No part of this manual may be reproduced or transmitted in any form or by any means, for any purpose other than the purchaser's personal use, without the expressed written permission of TSC Auto ID Technology Co.



Table of Contents

| | |
|--|----|
| 1. Introduction | 1 |
| 1.1 Product Specification..... | 2 |
| 1.1.1 Product standard feature | 2 |
| 1.1.2 Printer Optional Features | 5 |
| 1.2 Printer Specifications | 6 |
| 1.3 Print Specifications | 6 |
| 1.4 Ribbon Specifications | 7 |
| 1.5 Media Specifications..... | 7 |
| 2. Operation Overview..... | 8 |
| 2.1 Printer Overview | 9 |
| 2.1.1 Front View..... | 9 |
| 2.1.2 Interior View | 10 |
| 2.1.3 Rear View..... | 11 |
| 2.2 Front Panel Control..... | 11 |
| 2.2.1 LED Indication and Keypads | 12 |
| 2.2.2 Power-on Utilities | 14 |
| 3. Setup..... | 15 |
| 3.1 Setting up the printer..... | 15 |
| 3.2 Loading the Ribbon..... | 16 |

| | |
|--|----|
| 3.3 Loading the Media | 18 |
| 3.4 Loading the Fanfold/External Media..... | 20 |
| 3.5 Loading Media in Peel-off Mode (Option for ML240P Series)..... | 21 |
| 3.6 Loading Media in Cutter Mode (Option) | 22 |
| 4. Knob Adjustment | 23 |
| 4.1 Print Head Pressure Position Adjustment Knob | 23 |
| 4.1 Ribbon Tension Adjustment Knob | 24 |
| 4.2 Mechanism Fine Adjustment to Avoid Ribbon Wrinkles | 25 |
| 5. TSC Console..... | 27 |
| 5.1 Start TSC Console..... | 27 |
| 5.2 Setup Ethernet Interface | 29 |
| 5.3 Set Wi-Fi and Add to TSC Console Interface | 31 |
| 5.4 Initialize the Printer Wi-Fi Setting | 34 |
| 5.5 TPH Care..... | 35 |
| 5.6 Printer Function | 36 |
| 5.7 Setting Post-Print Action | 37 |
| 6. LCD Menu Function..... | 38 |
| 6.1 Enter the Menu | 38 |
| 6.2 Menu Overview | 39 |



- 6.3 Setting40
 - 6.3.1 TSPL41
 - 6.3.2 ZPL243
- 6.4 Sensor46
- 6.5 Interface.....47
 - 6.5.1 Serial Comm.....48
 - 6.5.2 Ethernet.....49
 - 6.5.3 Wi-Fi.....50
 - 6.5.4 Bluetooth51
- 6.6 Advanced52
- 6.7 File Manager54
- 6.8 Diagnostic.....55
- 6.9 Favorites56
- 7. Troubleshooting.....57
- 8. Maintenance.....60
- 9. Agency Compliance and Approvals62
- 10. Revision History71

1. Introduction

Thank you very much for purchasing TSC bar code printer.

The new high-performance ML240 Series, which have sleek design can deliver the cleanest and high quality barcodes. It features a die-cast aluminum print mechanism housed in a very strong yet lightweight cabinet. This new design results in a more durable printer that is suited for your most heavy-duty demand cycles.

There are four models available with ML240 and ML240P series. The ML240/ ML240P series prints at 203 dpi series are at speeds up to 6 inches per second, ML340/ ML340P series provides higher 300 dpi resolution at speeds up to 5 inches per second, which makes it ideal for printing very small 2D barcodes, graphics, fine print, and other ultra-high-resolution images.

This manual provides the essential information and clear instructions for operating MB240 series. To print label formats, please refer to the instructions provided with your labeling software. TSC printers include the Windows labeling software for creating your label template. For system integration, the TSPL/TSPL2 printer programming manual or SDKs can be found on TSC website at <https://www.tscprinters.com>

Applications

- Work In Process
- Product Marking
- Compliance Labeling
- Industrial-Duty Printing
- Packing
- Order Fulfillment
- Shipping/Receiving
- Inventory Management Retail
- Product Label
- Event Ticketing

1.1 Product Specification

1.1.1 Product standard feature

| Model | ML240 | ML340 | ML240P | ML340P |
|---------------------------------------|---|-------------------------------|---|-------------------------------|
| Resolution | 203 dots/inch (8 dots/mm) | 300 dots/inch (12 dots/mm) | 203 dots/inch (8 dots/mm) | 300 dots/inch (12 dots/mm) |
| Printing method | Thermal transfer & direct thermal | | | |
| Mechanism | High quality die-cast aluminum design | | | |
| LCD display/ Operation buttons | <ul style="list-style-type: none"> ■ 2 operation buttons (Pause and Feed) ■ 3 colors LED for notification light bar | | <ul style="list-style-type: none"> ■ 2 operation buttons (The meaning of the buttons will vary depend on the UI footer.) ■ 4 navigational keys ■ 3 colors LED for notification light bar | |
| Processor | 32-bit RISC high performance processor | | | |
| Memory | <ul style="list-style-type: none"> ■ 8MB Flash memory ■ 16MB DRAM | | <ul style="list-style-type: none"> ■ 128MB Flash memory ■ 64MB DRAM | |
| Interface | <ul style="list-style-type: none"> ■ USB 2.0 (High speed mode) | | <ul style="list-style-type: none"> ■ USB 2.0 (High speed mode) ■ Internal Ethernet (10/100 Mbps) ■ RS-232 (Max. 115,200 bps) ■ USB host: barcode scanner, PC keyboard, and USB storage device | |
| Sensors | <ul style="list-style-type: none"> ■ Gap transmissive sensor (Position adjustable, 5mm → 88mm) ■ Black mark reflective sensor (Position adjustable, 0mm → 81.7mm) | | <ul style="list-style-type: none"> ■ Gap transmissive sensor (Position adjustable, 5mm → 88mm) ■ Black mark reflective sensor (Position adjustable, 0mm → 81.7mm) | |

- Ribbon end sensor
- Head open sensor

- Ribbon end sensor
- Head open sensor

Internal font

- 8 alpha-numeric bitmap fonts
- One Monotype Imaging® CG Triumvirate Bold Condensed scalable font
- Built-in Monotype True Type Font engine

Supported code page

- Codepage 437 (English - US)
- Codepage 737 (Greek) -
- Codepage 850 (Latin-1)
- Codepage 852 (Latin-2)
- Codepage 855 (Cyrillic) -
- Codepage 857 (Turkish)
- Codepage 860 (Portuguese)
- Codepage 861 (Icelandic) -
- Codepage 862 (Hebrew) -
- Codepage 863 (French Canadian)
- Codepage 864 (Arabic) -
- Codepage 865 (Nordic)
- Codepage 866 (Russian) -
- Codepage 869 (Greek 2) -
- Codepage 950 (Traditional Chinese)
- Codepage 936 (Simplified Chinese)
- Codepage 932 (Japanese)
- Codepage 949 (Korean)
- Codepage 1250 (Latin-2)
- Codepage 1251 (Cyrillic)
- Codepage 1252 (Latin-1)
- Codepage 1253 (Greek)
- Codepage 1254 (Turkish)
- Codepage 1255 (Hebrew) -
- Codepage 1256 (Arabic)
- Codepage 1257 (Baltic)
- Codepage 1258 (Vietnam)
- ISO-8859-1: Latin-1 (Western European)
- ISO-8859-2: Latin-2 (Central European)
- ISO-8859-3: Latin-3 (South European)

- ISO-8859-4: Latin-4 (North European)
- ISO-8859-5: Cyrillic
- ISO-8859-6: Arabic
- ISO-8859-7: Greek
- ISO-8859-8: Hebrew
- ISO-8859-9: Turkish
- ISO-8859-10: Nordic
- ISO-8859-15: Latin-9
- UTF-8

| | | |
|-------------------------------------|--|--|
| Supported bar code | 1D bar code | 2D bar code |
| | Code128 subsets A.B.C, Code128UCC, EAN128, Interleave 2 of 5, Code 39, Code 93, EAN-13, EAN-8, Codabar, Standard 2 of 5, Industrial 2 of 5, POSTNET, UPC-A, UPC-E, EAN and UPC 2(5) digits add-on, MSI, PLESSEY, China Post, ITF14, EAN14, Code 11, TELPEN, PLANET, Code 49, Deutsche Post Identcode, Deutsche Post Leitcode, LOGMARS, RSS-Stacked, GS1 DataBar. | CODABLOCK F mode, DataMatrix, Maxicode, PDF-417, Aztec, MicroPDF417, QR code, RSS Barcode (GS1 Databar), TLC 39, RSS |
| Command set | TSPL-EZD™ | |
| Font & bar code rotation | 0, 90, 180, 270 degree | |
| Others | <ul style="list-style-type: none"> ■ Standard industry emulations right out of the box including Eltron®, Datamax® and Zebra® language support ■ Built-in Monotype True Type Font engine ■ Downloadable fonts from PC to printer memory | |

1.1.2 Printer Optional Features

The printer offers the following optional features.

| | ML240/ ML340 | | ML240P/ ML340P | | |
|---|--------------|----------------|----------------|---------------|----------------|
| | User option | Factory option | User option | Dealer option | Factory option |
| KP-200 Plus keyboard display unit | | | ✓ | | |
| Internal Bluetooth 4.2 MFi module in front panel | | ✓ | | | ✓ |
| Wi-Fi module without slot-in housing | | | | ✓ | |
| Wi-Fi module with slot-in housing | | | ✓ | | |
| Regular guillotine cutter module (Max. print speed: 4 ips/ Media thickness: 0.06 ~ 0.28 mm/ Media type: receipt, tag, and label liner w/o glue) | | | | ✓ | |
| Peel off module | | | | ✓ | |
| Cutter tray | | | ✓ | | |

Note:

1. Option for either Wi-Fi or Bluetooth only, not coexistence.
2. Except for the linerless cutter, all TSC regular/heavy duty/care label cutters DO NOT cut on media with glue.

1.2 Printer Specifications

| Model | ML240 | ML340 | ML240P | ML340P |
|-------------------------|---|-------|--|--------|
| Physical dimensions | 248 (W) x 245 (H) x 330 (D) mm | | | |
| Weight | 7.4 kg | | 7.6 kg | |
| Power | Auto sensing power supply (20% print ratio) ■ Input: AC 100-240V, 1.5A, 50/ 60Hz ■ Output: 60W | | | |
| Environmental condition | ■ Operation: 5°C ~ 40°C (41 ~ 104°F), 25%~85% non-condensing ■ Storage: -40°C ~ 60°C (-40 ~ 140°F), 10%~90% non-condensing | | ■ Operation: 0°C ~ 40°C (32 ~ 104°F), 25%~85% non-condensing | |
| Environmental concern | Comply with Energy Star 2.0, REACH, RoHS, and WEEE | | | |

1.3 Print Specifications

| Print Specifications | 203 dpi models | 300 dpi models |
|--|---|---|
| Print head resolution (dots per inch/mm) | 203 dots/inch (8 dots/mm) | 300 dots/inch (12 dots/mm) |
| Printing method | Thermal transfer and direct thermal | |
| Dot size (width x length) | 0.125 x 0.125 mm (1 mm = 8 dots) | 0.084 x 0.084 mm (1 mm = 12 dots) |
| Print speed (inches per second) | 1, 2, 3,...6 ips Up to 6 ips | 1, 2, 3,...5 ips Up to 5 ips |
| Max. print width | 108 mm (4.25") | 105.7 mm (4.16") |
| Max. print length | ML240: 110" (2,794 mm) ML240P: 1000" (25,400 mm) | ML340: 40" (1,016 mm) ML340P: 450" (11,430 mm) |
| Printout bias | Vertical: Max. 1 mm. Horizontal: Max. 1 mm | |

1.4 Ribbon Specifications

| | |
|-------------------------|----------------------------------|
| Ribbon outside diameter | Max. 81.3 mm O.D. |
| Ribbon capacity | 450 meter long |
| Ribbon core | 1" (25.4 mm) |
| Ribbon width | 40 mm ~ 110 mm (1.57" ~ 4.33") |
| Ribbon wound type | Ink coated inside/ outside wound |

1.5 Media Specifications

| | |
|----------------------------|---|
| Media roll capacity | 5.5" O.D; 1" or 1.5" I.D core |
| Media core diameter | 1" or 1.5" (25.4 mm or 38.1 mm) I.D. core |
| Media type | Continuous, die-cut, black mark, fan-fold, and notch |
| Media wound type | Outside wound |
| Media width | 20 mm ~ 118 mm (0.79" ~ 4.65") 20 mm ~ 114.3 mm (0.79" ~ 4.5") for peeler/ cutter mode |
| Media thickness | 0.06 mm ~ 0.19 mm |
| Label length | ▪ 5 mm ~ 25,400 mm (203 dpi series) ▪ 5 mm ~ 11,430 mm (300 dpi series) |
| Label length (peeler mode) | 25.4mm ~ 152.4mm (1" ~ 6") |
| Label length (cutter mode) | ▪ 25.4~2,794 mm (1" ~ 110") for 203dpi series ▪ 25.4~1,016 mm (1" ~ 40") for 300dpi series |
| Black mark | Min. 8 mm (W) x Min. 2 mm (H) |
| Gap height | Min. 2 mm |

2. Operation Overview

Please carefully inspect the packaging and printer upon receiving the bar code printer. Please retain the packaging materials in case you need to reship the printer.

Unpacking the printer, the following items are included in the carton.

- 1 printer unit
- 1 quick installation guide
- 1 power cord
- 1 USB interface cable

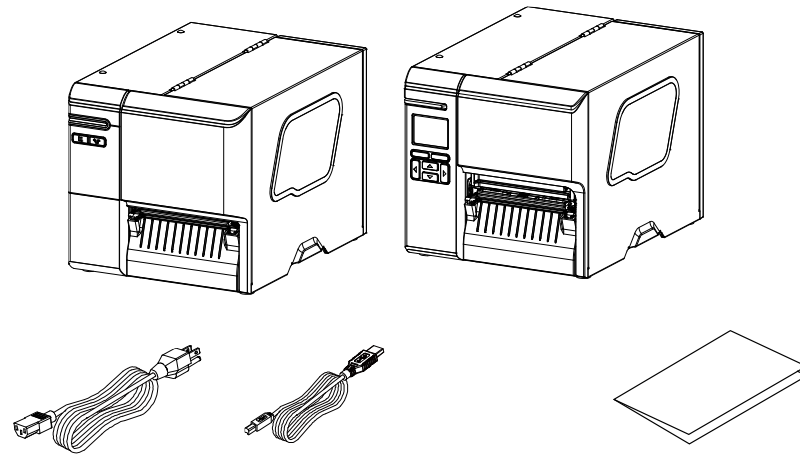

If any parts are missing, please contact the Customer Service Department of your purchased reseller or distributor.

2.1 Printer Overview

2.1.1 Front View

ML240 Series



1. LED indicator
2. Front panel buttons
3. Media view window
4. Paper exit chute
5. Media cover handle

ML240P Series



1. LED indicator
2. LCD display
3. Front panel buttons
4. Media view window
5. Paper exit chute
6. Media cover handle

2.1.2 Interior View

ML240/ML240P Series

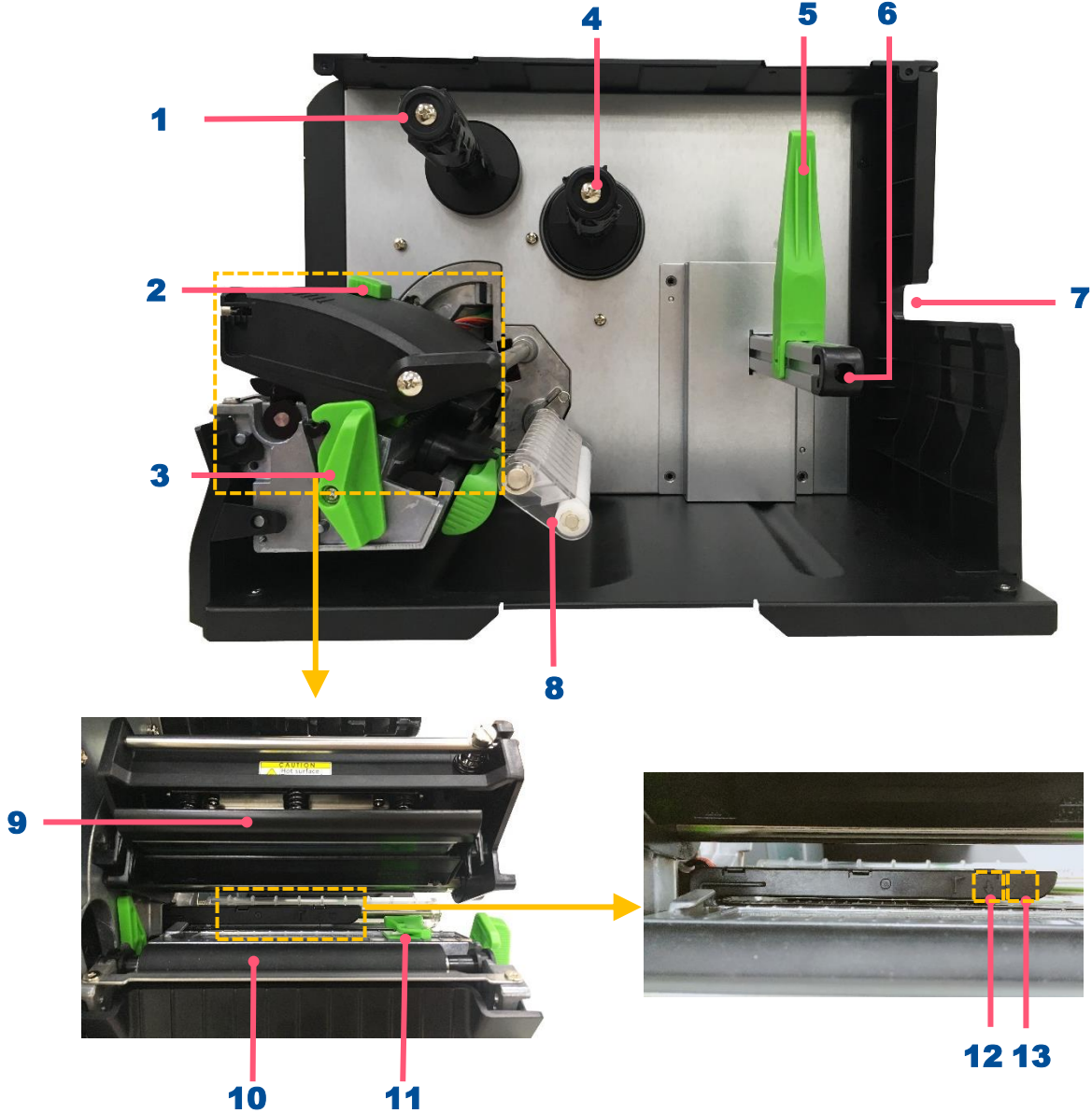

2.1.3 Rear View

ML240 Series



1. External label entrance chute
2. Power switch
3. USB interface (High speed mode)
4. Power cord socket

ML240P Series





1. External label entrance chute
2. Power switch
3. USB interface (High speed mode)
4. USB host
5. RS-232 interface
6. Slot-in Wi-Fi interface (Option)
7. Ethernet interface
8. Power cord socket

Note: The interface picture here is for reference only. Please refer to the product specification for the interfaces availability.



2.2 Front Panel Control

2.2.1 LED Indication and Keypads

LED color indication:

| Color | Meaning |
|---|--|
|  (Green) | Solid: Power is on and ready to be used. Flash : System is downloading data or printer is paused. |
|  (Amber) | System is clearing data. |
|  (Red) | Solid - Printer head open, cutter error. Flash - Printing error, such as paper empty, paper jam, ribbon empty, or memory error etc. |







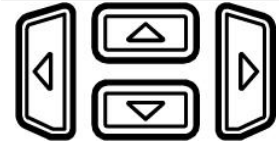

Keypads (ML240 Series):

| Keypads form | Item name | Function |
|---|-----------|-------------------------------------|
|  | Pause Key | Pause/ Resume the printing process. |
|  | Feed Key | Advance one label. |

Keypads (ML240P Series):

| Keypads form | Item name | Function |
|---|-------------------|-------------------------------|
|  | Select keys | Feed, Pause, Confirm, Cancel. |
|  | Navigational keys | Select / Navigate. |

Main Page Icon (ML240P Only)

| Icon | Indication |
|---|---|
|  | Wi-Fi device is ready (option). |
|  | Ethernet is connected. |
|  | Bluetooth device is ready (option). |
|  | Remaining amount of ribbon(m). |
|  | Security lock. |
|  | Enter the menu. |
|  | Enter cursor (be marked in green) located option. |
|  | Feed button (advance one label). |

2.2.2 Power-on Utilities

Power-on Utilities provides the basic functions and can be activated by below procedures:

Turn off the power > **Hold** right side select keys > **Open** the power > **Release** the button depending on the color of the LED.

ML240 Series: power down and hold the right side of the **Select Keys**  to restart the printer.

Sequences of the settings:

| LED Colors Functions | Amber | Red (5 blinks) | Amber (5 blinks) | Green (5 blinks) | Green / Amber (5 blinks) | Red / Amber (5 blinks) | Solid green |
|---|-------|-------------------|---------------------|---------------------|--------------------------------|------------------------------|----------------|
| 1. Sensor Calibration (Gap / black mark sensor) | | Release | | | | | |
| 2. Self-Test (And enter dump mode) | | | Release | | | | |
| 3. Factory Default | | | | Release | | | |
| 4. Bline Calibration | | | | | Release | | |
| 5. Gap Calibration | | | | | | Release | |
| 6. READY (Skip AUTO.BAS) | | | | | | | Release |

3. Setup

3.1 Setting up the printer

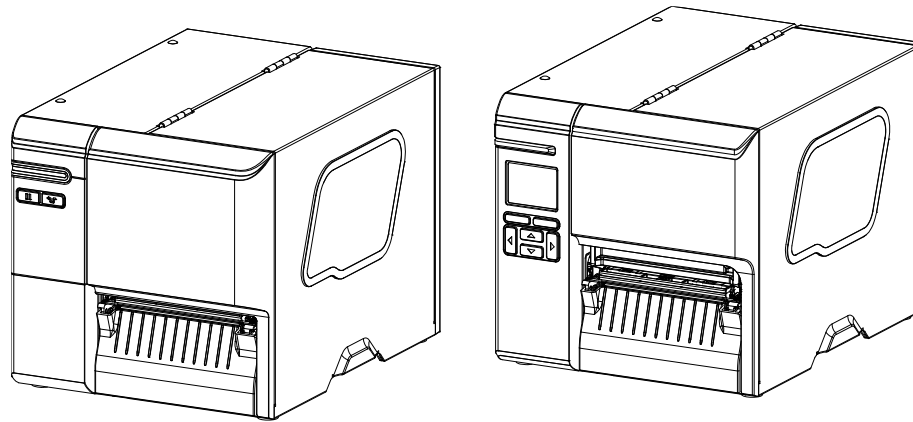

1. Place the printer on a flat surface.
 2. Make sure the printer is power off.
 3. Connect the printer to the computer with the provided USB cable.
 4. Plug in the power cord.
- ◆ **Note: Please switch OFF the printer before plugging in the power cord to printer power jack.**

3.2 Loading the Ribbon



1. Open the media cover.



2. Install the ribbon onto ribbon supply spindle and install paper core onto ribbon rewind spindle.



3. Release lever to open print head.

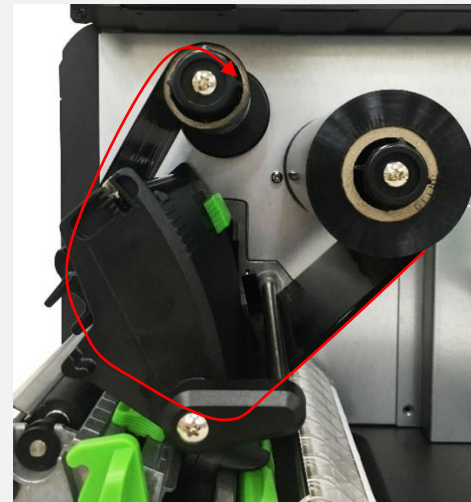

4. Thread ribbon below the ribbon guide bar through ribbon sensor slot.

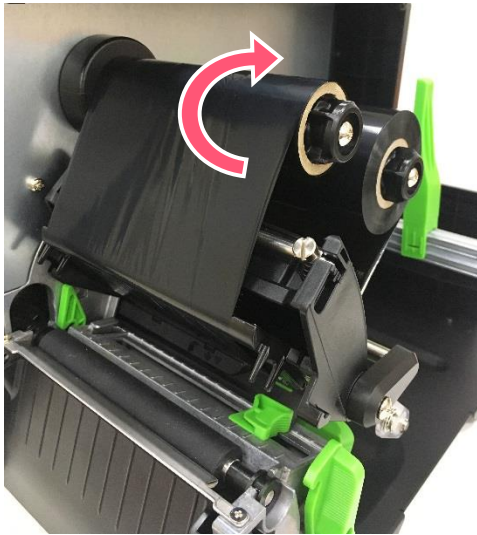

5. Wind the ribbon rewind spindle counterclockwise until the ribbon is smooth, properly stretched and wrinkle-free.

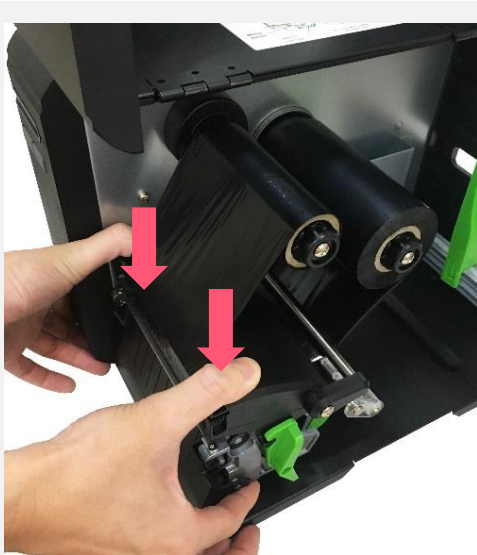

6. Close the print head.

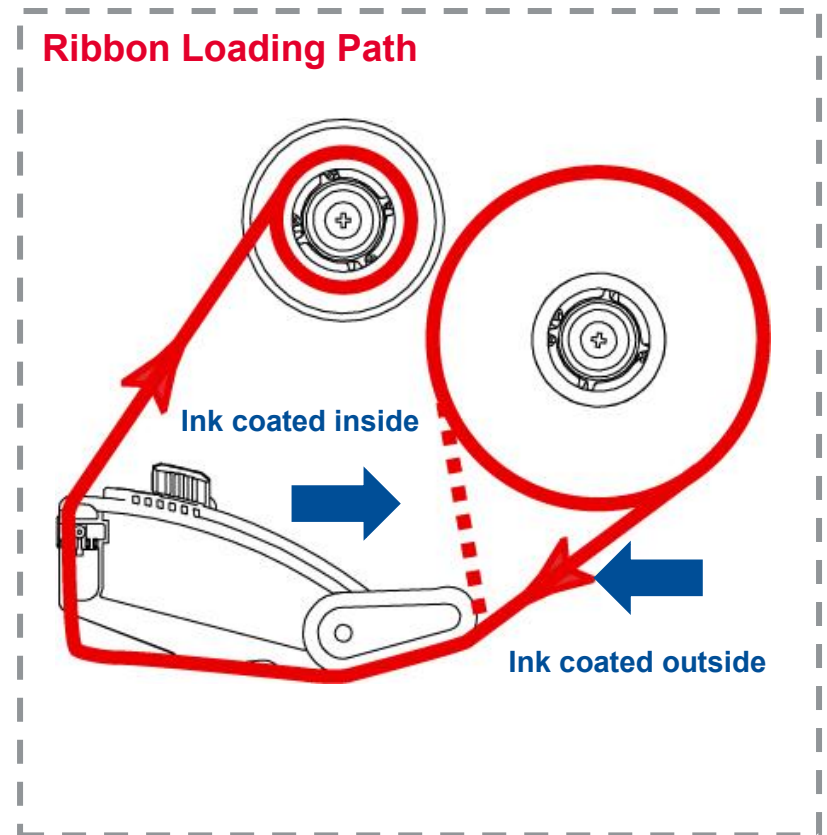

3.3 Loading the Media



1. Open the media cover.

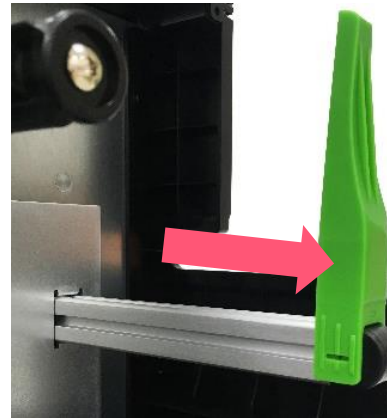

2. Move the label roll guard horizontally to the end of label spindle and flip it down.

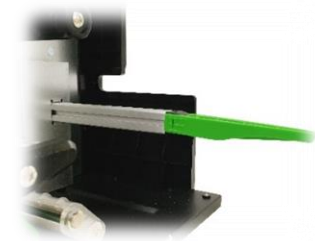

3. Place the media roll on the label supply spindle and use label roll guard to fix it.



4. Release lever and thread the label through the damper, media sensor, and label guide to install the media.

5. Adjust the media sensor position adjustment knob, making sure the sensor can detect the media.

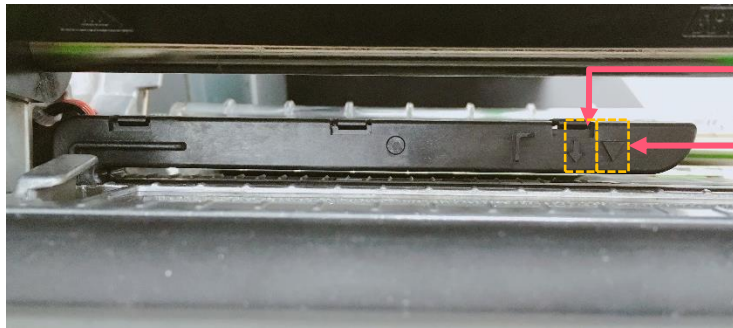

Black mark sensor (shown as ↓)

Gap sensor (shown as ▽)

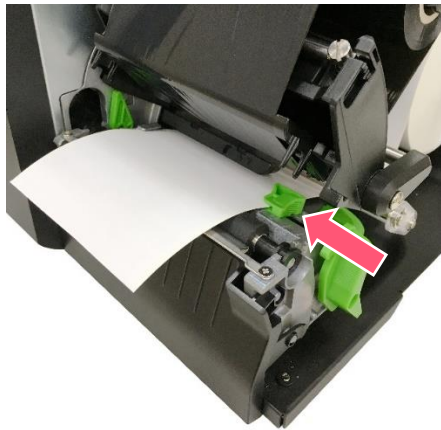

6. Adjust the label guide to fix the media position.

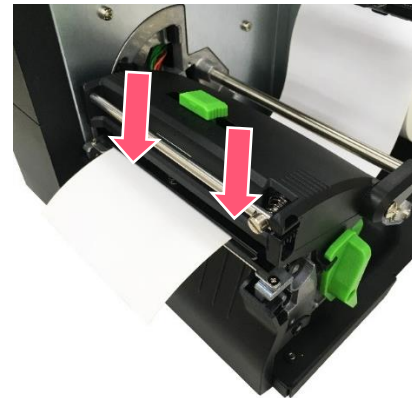

7. Close the print head mechanism on both sides and make sure the latches had engaged securely.
8. Set media sensor type and calibrate the selected sensor.

Note:

* When installing label with 1 to 2 inches width, please adjust Print Head Pressure Position Adjustment Knob to left side.



3.4 Loading the Fanfold/External Media

1. Open the printer right side cover.
2. Insert the fanfold media through the rear external label entrance chute.
3. Refer 3.3 to load the media.



Note: Please calibrate the gap/black mark sensor when changing media.

Loading path for fan-fold labels

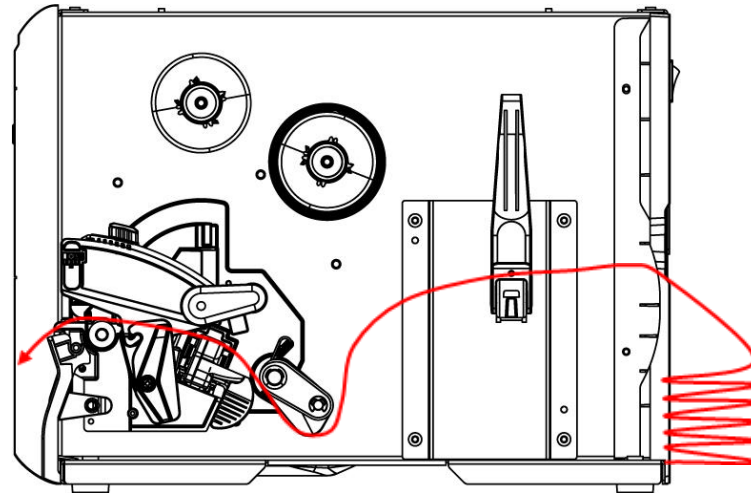

3.5 Loading Media in Peel-off Mode (Option for ML240P Series)



1. Open the media cover



2. Load the media and use front panel to make calibration, setting print mode to Peeler Mode.

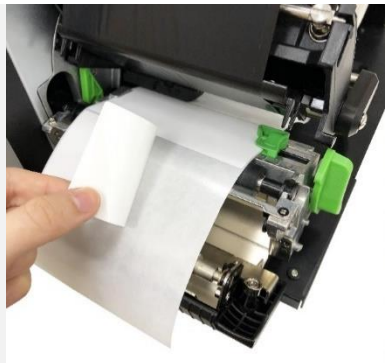

3. Open print head release and peel-off module, pull approximately 650 mm of the label and remove several labels.

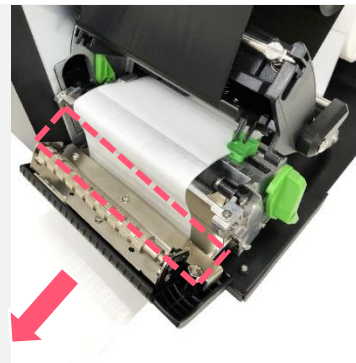

4. Feed the leading edge of liner through the peel-off module slot.



5. Close print head, peel-off module, and the media cover. Press FEED button to test the function.

3.6 Loading Media in Cutter Mode (Option)



1. Open the media cover



2. Load the media and use front panel to make calibration, setting print mode to Cutter Mode.



3. Open print head and cutter module , threading the media through the slot.



4. Close print head and cutter module. Press FEED to test the function.

4. Knob Adjustment

4.1 Print Head Pressure Position Adjustment Knob

The print head pressure adjustment knob has 9 positions from left to right. Due to printer's paper alignment is on left side of the mechanism, different media width requires the different pressure. Users can try which level can meet their expectation.

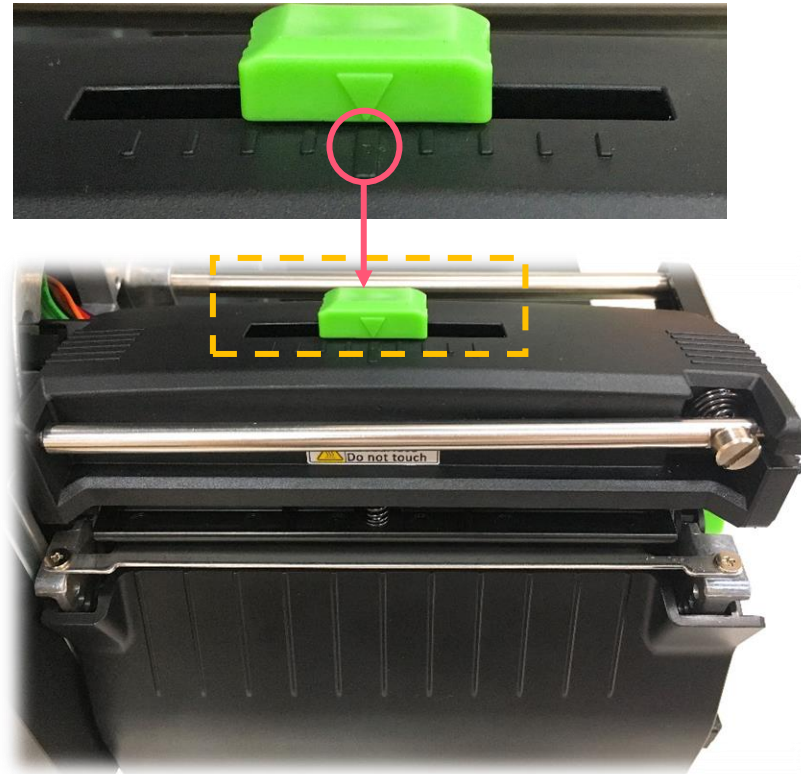

4.1 Ribbon Tension Adjustment Knob

Ribbon Tension Adjustment Knob has five positions for adjustment. Due to the ribbon is aligned to the inbound of print mechanism, different width of ribbons may need to adjust the tension adjustment knob to avoid the ribbon wrinkle and get the best print quality.

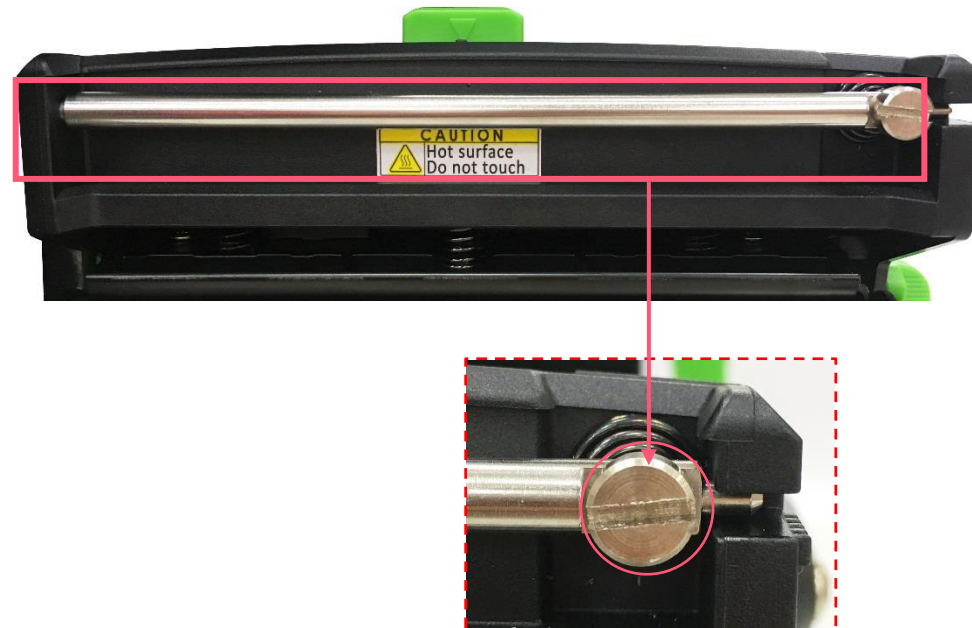

4.2 Mechanism Fine Adjustment to Avoid Ribbon Wrinkles

Ribbon wrinkle is related to the media width, thickness, print head pressure balance, ribbon film characteristics, print darkness setting...etc. In case the ribbon wrinkle happens, please follow the instructions below to adjust the printer parts.

Wrinkle happens from label lower right to upper left direction



- Switch the ribbon tension adjustment knob clockwise per 1 level and print the label again to check if the wrinkle is gone.
- If the tension adjustment knob has positioned on the level of innermost side but does not improve the ribbon wrinkle, please switch the print head pressure adjustment knob per level and print the label again to check if the wrinkle is gone.
- If the wrinkle can't be avoided, please contact the Customer Service Department of your purchased reseller or distributor for service.

Wrinkles happens from label lower left to upper right direction



- Switch the ribbon tension adjustment knob clockwise per 1 level and print the label again to check if the wrinkle is gone.
- If the tension adjustment knob has positioned on the level of outermost side but does not improve the ribbon wrinkle, please switch the print head pressure adjustment knob per level and print the label again to check if the wrinkle is gone.
- If the wrinkle can't be avoided, please contact the Customer Service Department of your purchased reseller or distributor for service.

5. TSC Console

TSC Console is a management tool combining the Printer Management, Diagnostic Tool, CommTool and Printer Webpage settings, which enables you to adjust printer's settings/status; change printers' settings; download graphics, deploy fonts, graphics, label templates or upgrade the firmware to the group of printers, and send additional commands to printers at the same time.

※ **Printer firmware version before A2.12 will only use 9100 Port as command port; Printer firmware after A2.12 will use 6101 Port as command port.**

5.1 Start TSC Console

1. Double click TSC Console icon to start the software.

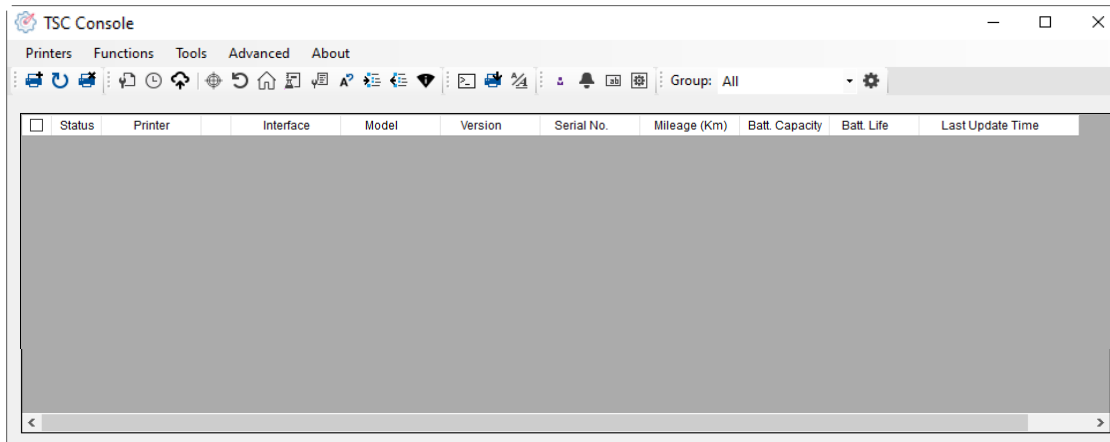

2. Manually add the devices by clicking **Printer > Add Printers**.

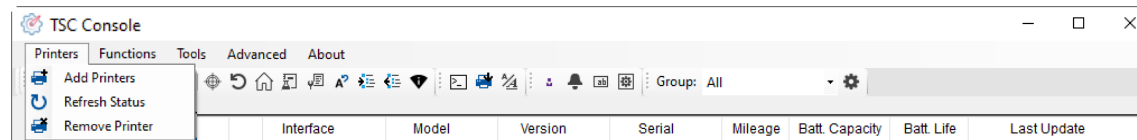

3. Select the current interface of the printer.

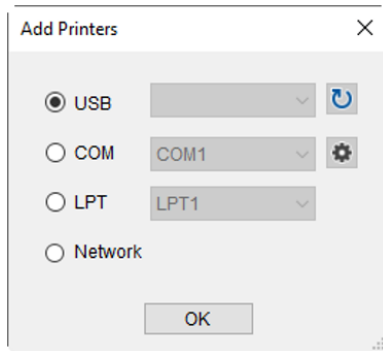

4. The printer will be added to **TSC Console**'s interface.

5. Select the printer and set the settings.

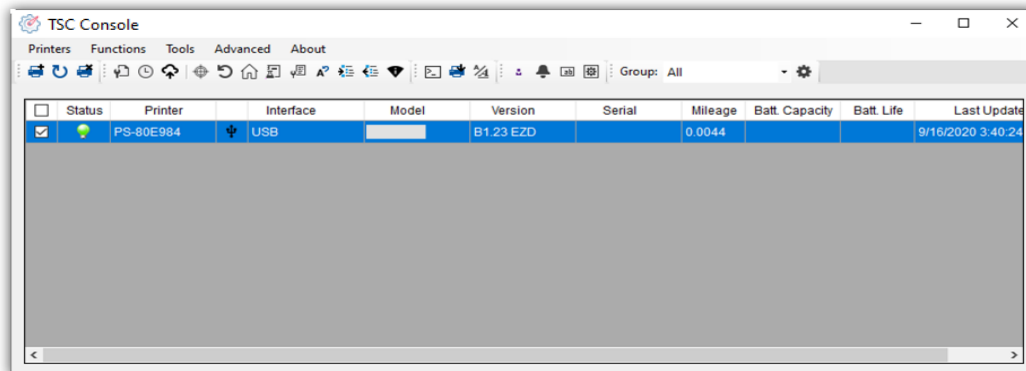

- For more information, please refer to **TSC Console User Manual**.

5.2 Setup Ethernet Interface

- Use **USB** or **COM** to establish the interface on **TSC Console**.

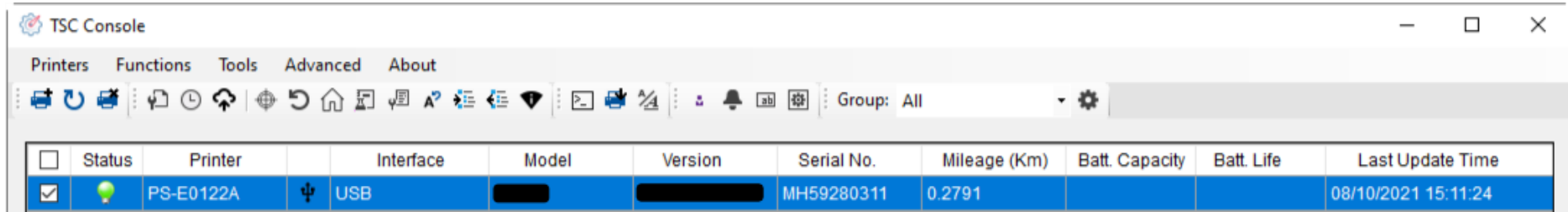

The screenshot shows the TSC Console software interface. At the top, there are menu options: Printers, Functions, Tools, Advanced, and About. Below the menu is a toolbar with various icons. A status bar at the bottom of the toolbar shows 'Group: All'. The main area contains a table with the following columns: Status, Printer, Interface, Model, Version, Serial No., Mileage (Km), Batt. Capacity, Batt. Life, and Last Update Time. The table has one row of data:

| Status | Printer | Interface | Model | Version | Serial No. | Mileage (Km) | Batt. Capacity | Batt. Life | Last Update Time |
|-------------------------------------|-----------|-----------|-------|---------|------------|--------------|----------------|------------|---------------------|
| <input checked="" type="checkbox"/> | PS-E0122A | USB | | | MH59280311 | 0.2791 | | | 08/10/2021 15:11:24 |

- Double click to enter the **Printer Configuration Page** > Click **Ethernet** tab > Check the **IP Address**.

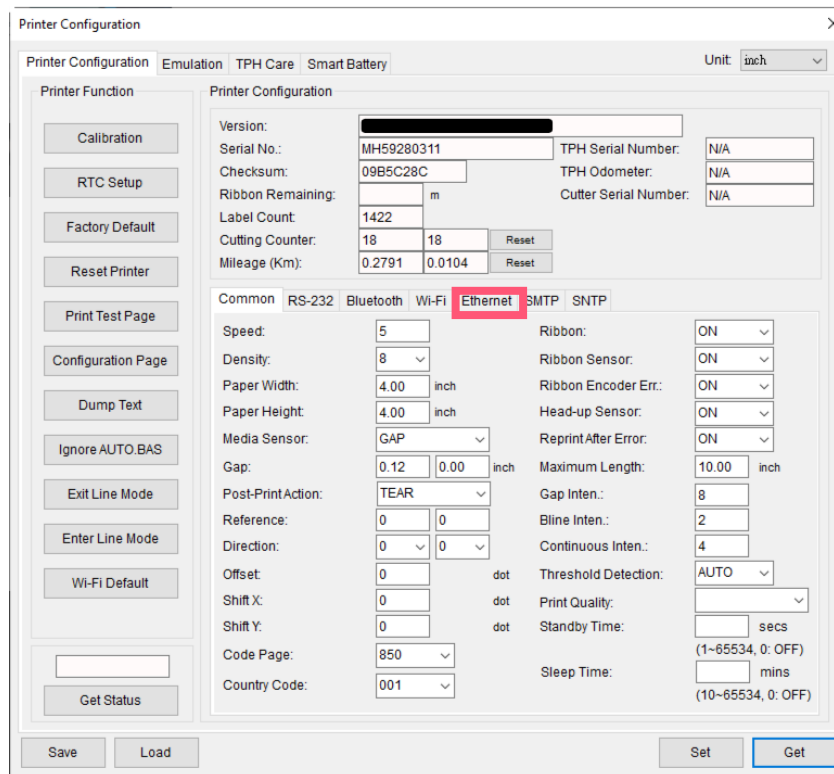

The screenshot shows the 'Printer Configuration' dialog box. The 'Printer Configuration' tab is selected. The 'Ethernet' sub-tab is highlighted with a red box. The 'Ethernet' sub-tab contains the following settings:

| Common | RS-232 | Bluetooth | Wi-Fi | Ethernet | SMTP | SNTP |
|---|--------|-------------------|-------|----------|------|------|
| <input checked="" type="radio"/> DHCP <input type="radio"/> Static IP | | | | | | |
| IP Address: | | 10.0.10.181 | | Set | | |
| Subnet Mask: | | 255.255.255.0 | | Set | | |
| Gateway: | | 10.0.10.251 | | Set | | |
| MAC Address: | | 00-1B-82-E0-12-2A | | Set | | |
| Primary DNS IP: | | | | Set | | |
| Secondary DNS IP: | | | | Set | | |
| Printer Name: | | PS-E0122A | | Set | | |
| Raw Port: | | 9100 | | Set | | |

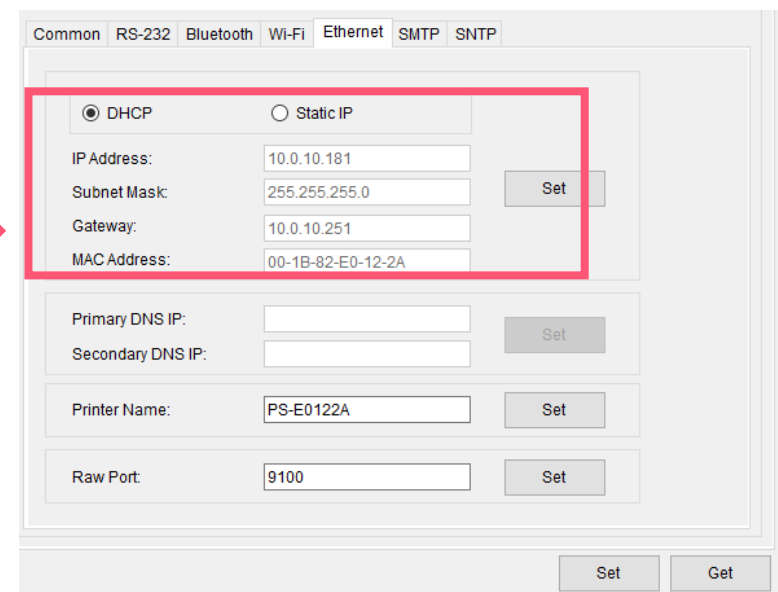

The screenshot shows a close-up of the Ethernet configuration settings. The 'DHCP' radio button is selected, and the 'Static IP' radio button is unselected. The IP Address field is highlighted with a red box and contains the value '10.0.10.181'. The Subnet Mask field contains '255.255.255.0'. The Gateway field contains '10.0.10.251'. The MAC Address field contains '00-1B-82-E0-12-2A'. There are 'Set' buttons next to the IP Address, Subnet Mask, Gateway, and MAC Address fields.

- Return to **TSC Console** main page > Click **Add Printer** on the top left of the window.

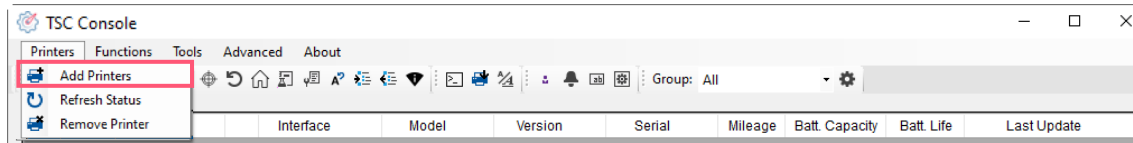

- Choose **Network** > Key in the **IP Address** > Click **Discover** to establish the Ethernet interface.

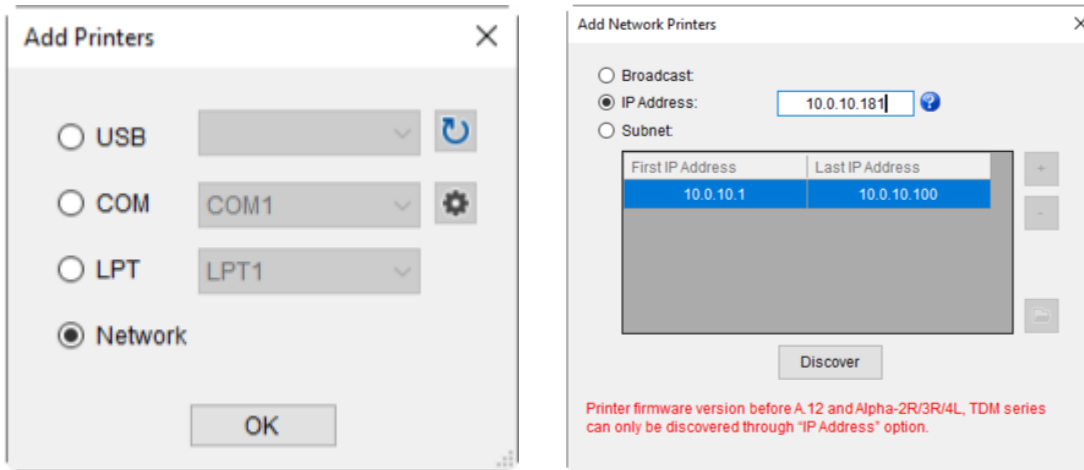

- The notification will pop up > Click **OK** to close the window > The Ethernet interface will be shown on **TSC Console**.

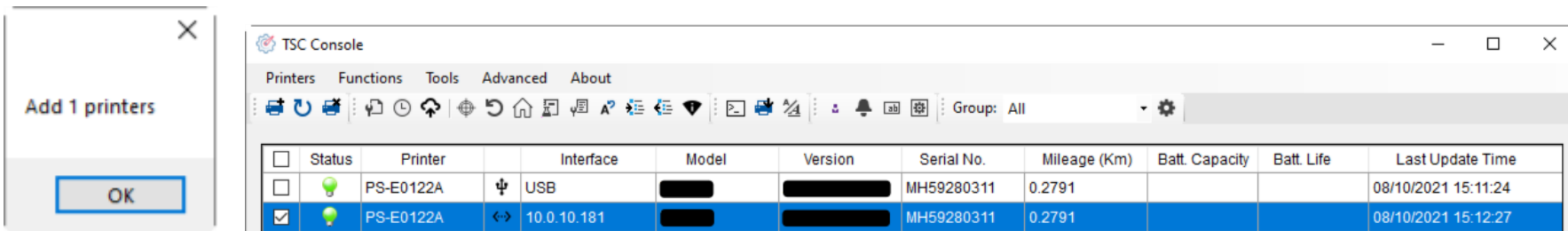

5.3 Set Wi-Fi and Add to TSC Console Interface

- Use **USB** or **COM Port** to set up the interface.
(refer to chp.5.1)
- Double click to enter the printer configuration page.

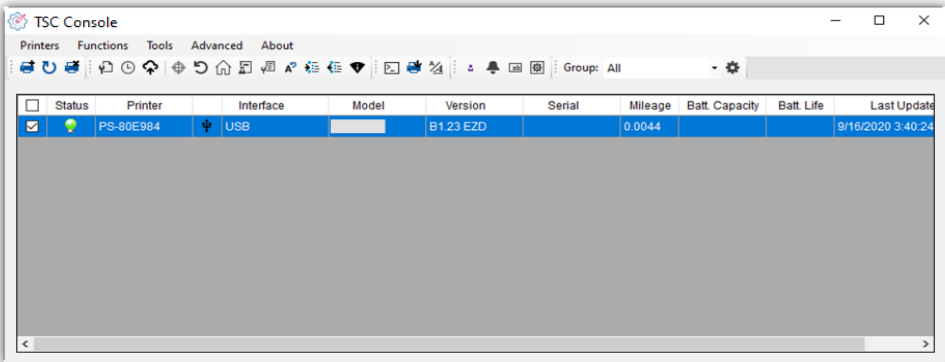

- Click **Get** to receive printer's information.
- Click **Wi-Fi** to the wi-fi setting page.

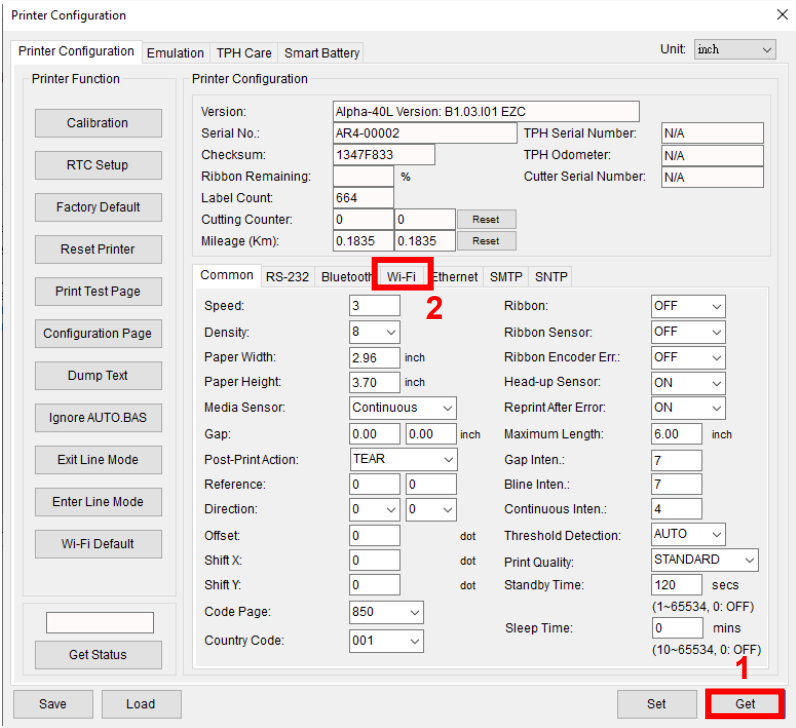

For WPA-Personal

- I. Fill-in the **SSID**.
- II. Select the Encryption option to **WPA-Personal**.
- III. Fill-in the Key.
- IV. Select **DHCP** to **ON**. (For **OFF** option, please fill-in the IP Address, Subnet Mask and Gateway)
- V. After setting, click the **Set** button.

Note:

Before setting, the entered field will be shown in yellow for reminding.

On DHCP, user can change the printer name by another model name in "Printer Name" field.

User also can change the raw port in "Raw Port" field.

Common RS-232 Bluetooth Wi-Fi Ethernet SMTP SNTP

Built-in Wi-Fi Module

SSID: SSID_1

WLAN Encryption: WPA-Personal

Key: ●●●●

DHCP: ON

IP Address: 1

Subnet Mask: 0.0.0.0

Gateway:

Primary DNS IP:

Secondary DNS IP:

Raw Port: 9100

Printer Name: PS-FF153C

MAC Address: 00:1B:82:FF:15:3C

EAP Type:

Username:

Password:

File Name Browse

CA Certificate:

Client Certificate:

Private Key:

EAP-FAST PAC:

Wi-Fi Version: 3.7.1.0R6

RSSI: 0

Set Get

For WPA-Enterprise

- I. Fill-in the **SSID**.
- II. Select the Encryption option to **WPA2-Enterprise**.
- III. Select DHCP to **ON** (For **OFF** option, please fill-in the IP Address, Subnet Mask and Gateway)
- IV. Select the **EAP Type** option. (For **EAP-TLS** option, please upload the CA and Key for mutual authentication, integrity-protected cipher suite negotiation, and key exchange between two endpoints.)
- V. After setting, click the **Set** button.

Note:

Before setting, the entered field will be shown in yellow for reminding.

On DHCP, user can change the printer name by another model name in "Printer Name" field.

User also can change the raw port in "Raw Port" field.

Common RS-232 Bluetooth Wi-Fi Ethernet SMTP SNTP

Built-in Wi-Fi Module

SSID: SSID_2

WLAN Encryption: WPA-Enterprise

Key: ●●●●

DHCP: ON

IP Address: 1

Subnet Mask: 0.0.0.0

Gateway:

Primary DNS IP:

Secondary DNS IP:

Raw Port: 9100

Printer Name: PS-FF153C

MAC Address: 00:1B:82:FF:15:3C

EAP Type: 2

Username:

Password:

File Name Browse

CA Certificate:

Client Certificate:

Private Key:

EAP-FAST PAC:

Wi-Fi Version: 3.7.1.0R6

RSSI: 0

Set Get

- After clicking **Set** button, it'll pop-up the window tip as below shown.

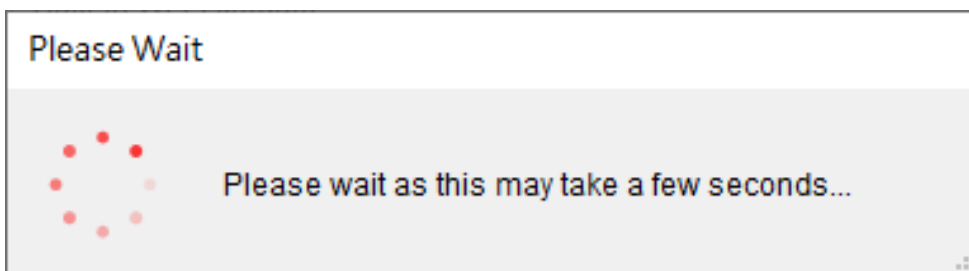

- IP address will be shown in the "IP address" field and the Wi-Fi logo and IP address will be displayed on the LCD control panel.

Note:

IP address should be shown within about 5~15 seconds after printer turn on. If not, please refer to steps below to initialize the printer Wi-Fi module settings then to setup it again.

- Remove the cable between the computer and the printer.
- Go to main page, click **Add Printer** to add the printer via **Network**.
- Select the printer and enter the setting page by double clicking the printer.
- Click the **Print Test Page** button to print the test page via Wi-Fi interface.

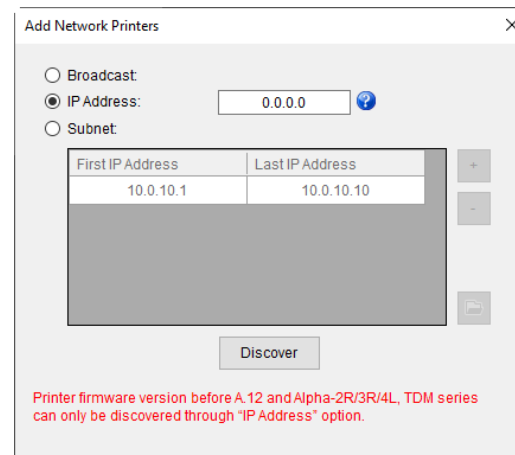

5.4 Initialize the Printer Wi-Fi Setting

1. Return to the main page of TSC Console.

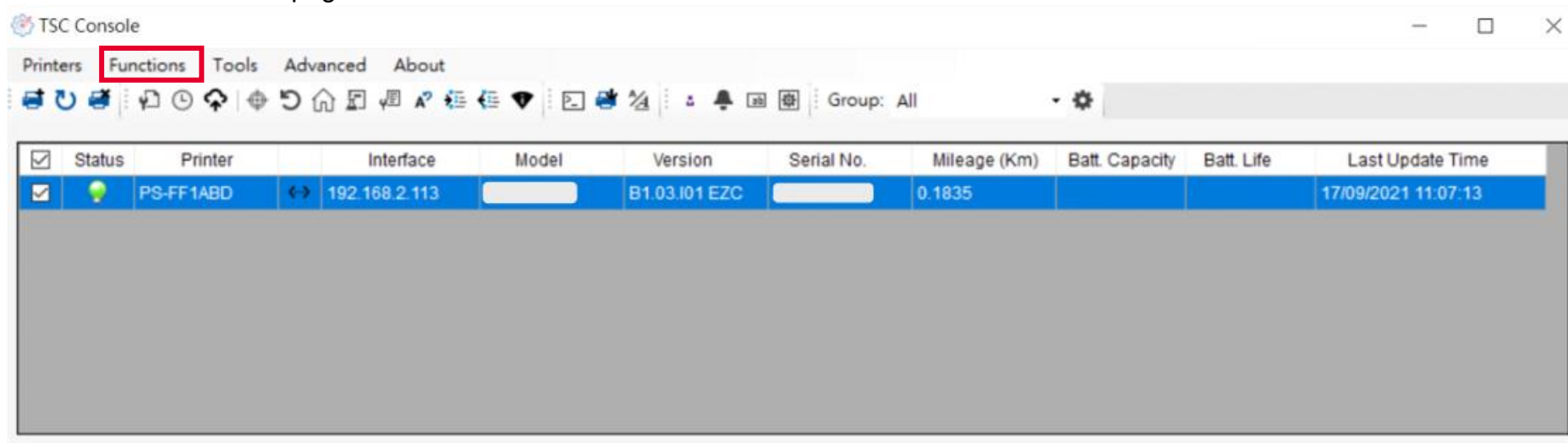

2. Click **Functions** to expand the page.
3. Click **Wi-Fi Default** to initialize the printer Wi-Fi module setting to factory default setting.

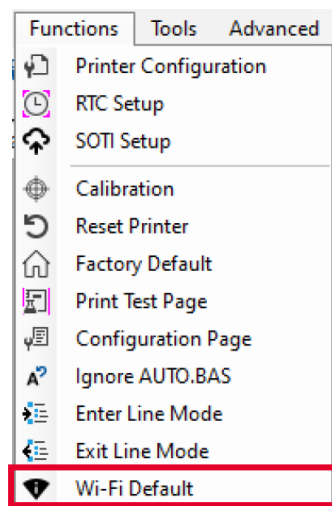

5.5 TPH Care

TPH Care provides users to check the condition of the print head and be able to set the dot failure threshold for indicating errors when the threshold is triggered.



This option is used to enable (ON)/ disable (OFF) the TPH care function.

This option is used to check the numbers of unhealthy TPH dot element.

This option is used to detect the unhealthy TPH dot.

This option is used to set the threshold for unhealthy TPH dot number.

This image is used to check the relative position of the unhealthy TPH dot.

This option is used to print a TPH test image to check the TPH printing result.

1. Enable the TPH Care function. (Note: The default is disabled/OFF.) Then click "Get TPH care profile" button and a diagram will show in the area above.
2. If the profile is flat, it means that the print head is good. Check "Unhealthy TPH dot number". If the result is zero (0), that means the print head is good.
3. Bad dots are presented as a spike in the profile. The arrow in below profile indicates the presence of potentially damaged dots and printer will stop printing.

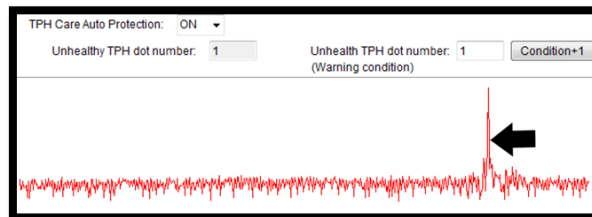

5.6 Printer Function

Printer Function could be found in **Printer Configuration**. “Printer Function” will be shown on the left side of the window.



| Functions | Description |
|---------------------------|--|
| Calibrate Sensor | Detect media types and the size of the label |
| RTC Setup | Synchronize printer with Real Time Clock on PC |
| Factory Default | Initialize the printer to default settings |
| Reset Printer | Reboot printer |
| Print Test Page | Print test page according to the specified label size and sensor type. |
| Configuration Page | Print printer configurations |
| Dump Text | Activate the printer to dump mode |
| Ignore AUTO.BAS | Ignore AUTO.BAS file when printer boot up. |
| Exit Line Mode | Exit the line mode to page mode |
| Enter Line Mode | Leave page mode and enter line mode |
| Reset WiFi | Restore the Wi-Fi settings to defaults. |

5.7 Setting Post-Print Action

When the printer is equipped with other option kits, ex: cutter, peeler, rewinder, please select the mode after finishing the calibration.

Follow below procedure to set the post action for the printing:

Refer Ch 5.1 to Connect the printer with **TSC Console** > **Double click** the printer > The **Printer Configuration Page** will pop up > Click **Get** to load information > Go to **Common Tab** > Find **Post-Print Action** > **Select the mode** depends on users' application > Click **Set**.

The screenshot shows the 'Printer Configuration' window with the 'Common' tab selected. The 'Post-Print Action' dropdown menu is open, showing options: OFF, TEAR, PEEL, CUTTER, REWIND, and APPLICATOR. A red box highlights the dropdown menu, and a blue circle with the number '2' is next to it. Another red box highlights the 'Set' button at the bottom right, with a blue circle and the number '1' next to it. A third red box highlights the 'Get' button at the bottom right, with a blue circle and the number '3' next to it. The interface includes various configuration fields for speed, density, paper width, paper height, media sensor, and other printer settings.

| Printer Function | Printer Configuration |
|--------------------|--|
| Calibration | Version: [] |
| RTC Setup | Serial No.: [] TPH Serial Number: N/A |
| Factory Default | Checksum: 1344B9B1 TPH Odometer: N/A |
| Reset Printer | Ribbon Remaining: [] % Cutter Serial Number: N/A |
| Print Test Page | Label Count: 553 |
| Configuration Page | Cutting Counter: 0 0 [Reset] |
| Dump Text | Mileage (Km): 0.0913 0.0913 [Reset] |
| Ignore AUTO.BAS | Common RS-232 Bluetooth Wi-Fi Ethernet SMTP SNTP |
| Exit Line Mode | Speed: 3 Ribbon: OFF [v] |
| Enter Line Mode | Density: 8 [v] Ribbon Sensor: OFF [v] |
| Wi-Fi Default | Paper Width: 104.00 mm Ribbon Encoder Err.: OFF [v] |
| Get Status | Paper Height: 74.05 mm Head-up Sensor: ON [v] |
| Save | Media Sensor: Black Mark [v] Reprint After Error: ON [v] |
| Load | Gap: 1.99 0.00 mm Maximum Length: 152.25 mm |
| | Post-Print Action: [v] Gap Inten.: 7 |
| | Reference: OFF Bline Inten.: 7 |
| | Direction: TEAR Continuous Inten.: 4 |
| | Offset: PEEL Threshold Detection: AUTO [v] |
| | Shift X: CUTTER [dot] Print Quality: STANDARD [v] |
| | Shift Y: REWIND [dot] Standby Time: 120 secs |
| | Code Page: 850 [v] Sleep Time: 0 mins |
| | Country Code: 001 [v] (1~65534, 0: OFF) |
| | (10~65534, 0: OFF) |



6. LCD Menu Function

6.1 Enter the Menu

- **By touch display:**

Tap the  (Menu) icon on LCD main page to enter the menu.

- **By Keys:**

Use navigational keys to select the  (Menu) icon (be marked in green) and press the left soft key button (means ) to enter the menu.

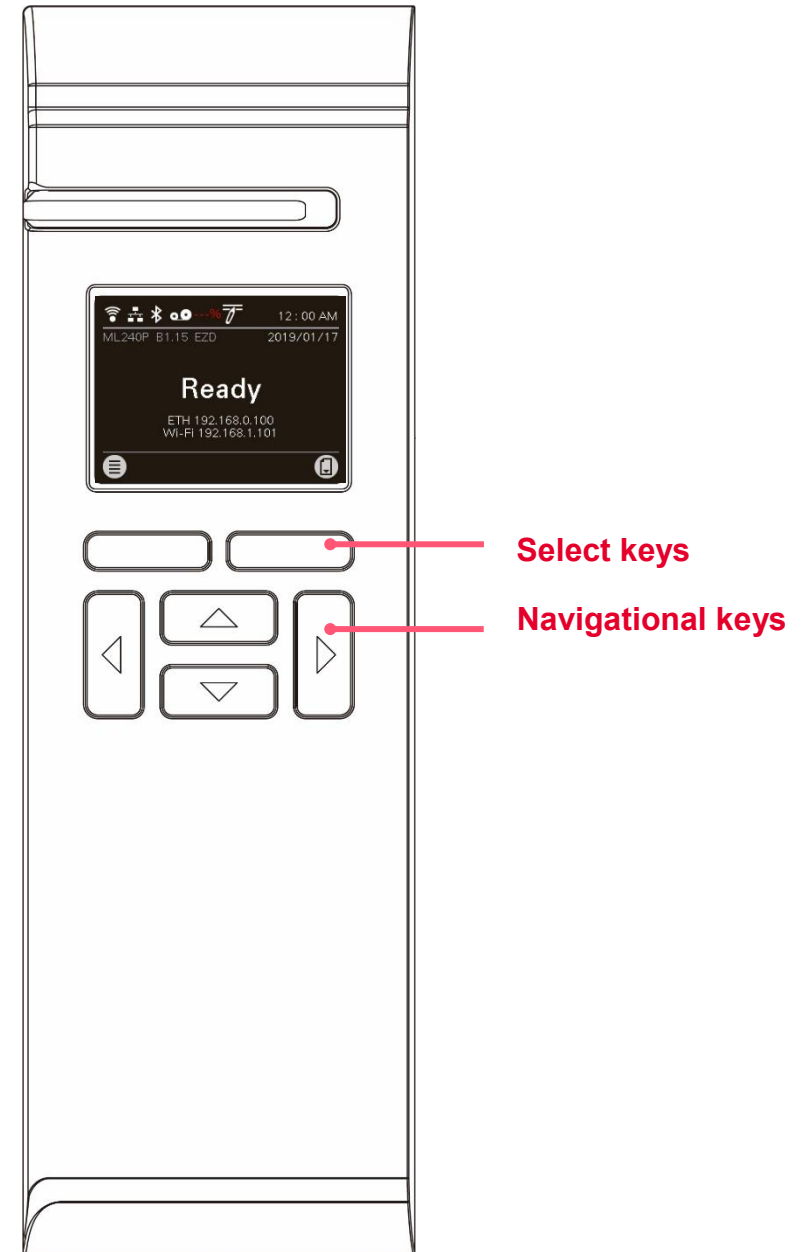

6.2 Menu Overview

There are 6 categories on the menu. Users can easily set the settings of the printer without connecting the computer. Please refer to following sections for more details.



Setting : To set up the printer settings for TSPL & ZPL2.



Advanced : To set LCD, initialization, cutter type,...etc.



Sensor : To calibrate the selected media sensor.



File Manager : To check and manage printer's memory storage.

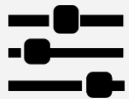

Interface : To set the printer interface settings.



Diagnostic : To check printer and help users to troubleshoot the problems.

6.3 Setting

Tap the **Command Set** on LCD to switch between TSPL and ZPL2. **Command Set** can also be activated by **Navigational Keys**.

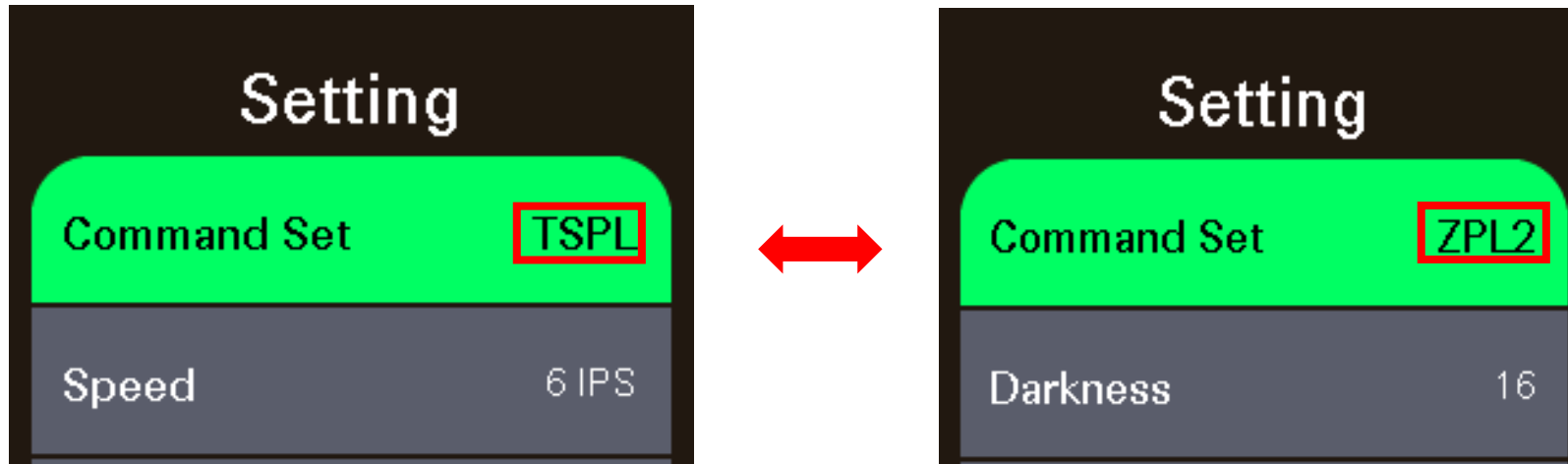

6.3.1 TSPL

TSPL category can set up the printer settings for TSPL.

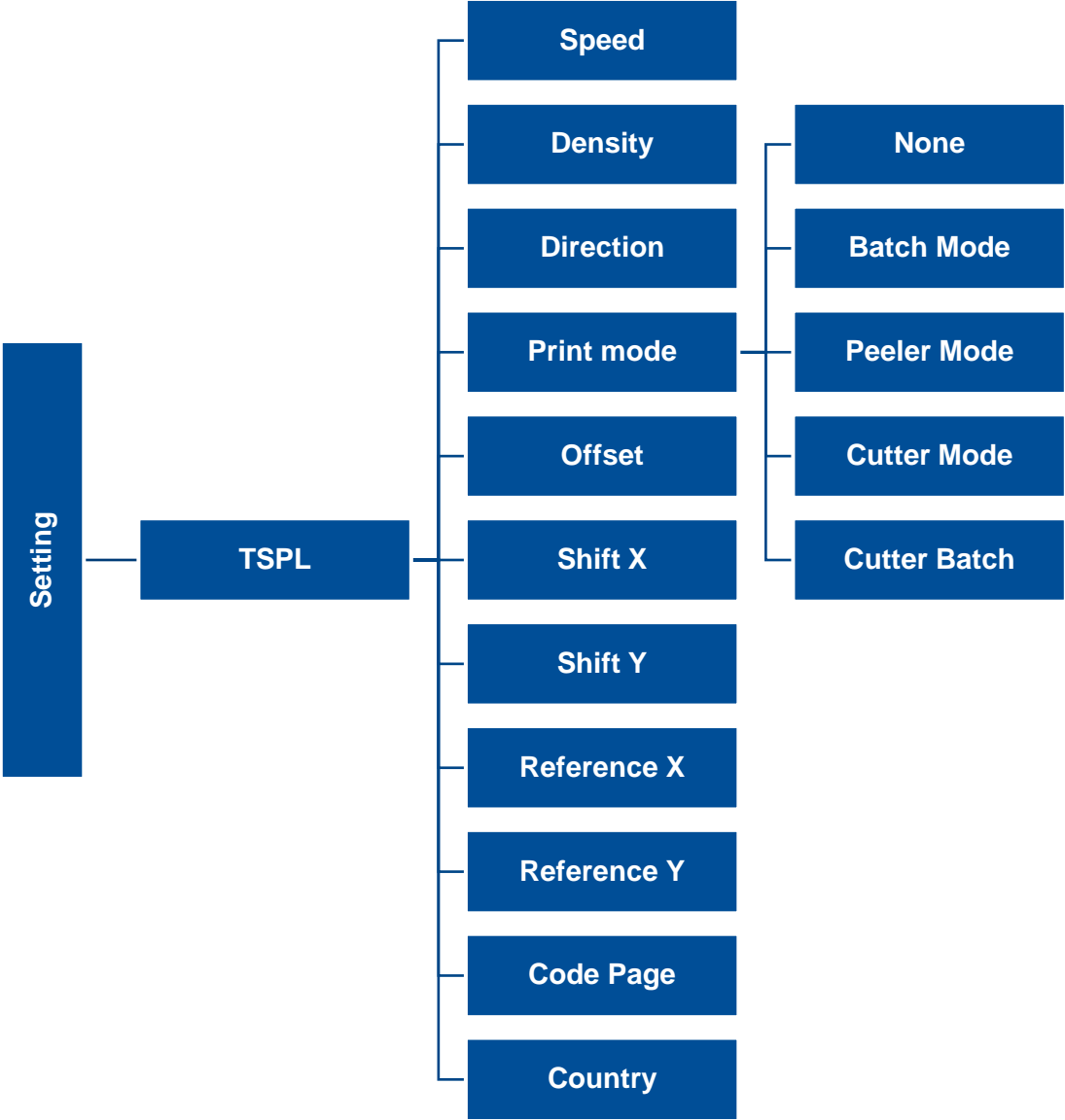

| Item | Description | Default |
|--------------------|---|----------------------------------|
| Speed | Set the print speed. Setting range: 1~6 for 203dpi; 1~5 for 300dpi . | 203 dpi: 5 300 dpi: 3 |
| Density | Set printing darkness. Setting range: 0 to 15, and the step is 1. | 8 |
| Direction | Set the printout direction. Setting Value: 0 and 1. Direction 0: <input type="text" value="Direction"/> Direction 1: <input type="text" value="Direction"/> | 0 |
| Print mode | Set the print mode. There are 6 modes in total: None: Next label top of form is aligned to the print head burn line location. (Tear Off Mode) Batch Mode: Once finishing the printing process, label will be fed to the tear plate location. Peeler Mode: Enable the label peel off mode. Cutter Mode: Enable the label cutter mode. Cutter Batch: Cut the label once at the end of the printing job. | Batch Mode |
| Offset | Adjust media stop location. Available value setting range: -999 dots to 999 dots. | 0 dot |
| Shift X | Adjust print position. Available value setting range: -999 dots to 999 dots. | 0 dot |
| Shift Y | | 0 dot |
| Reference X | Set the origin of printer coordinate system horizontally and vertically. Available setting range: 0 dot to 999 dots. | 0 dot |
| Reference Y | | 0 dot |
| Code page | Set the code page of international character set. | 850 |
| Country | Set the country code. Available setting value range: 1 to 358. | 001 |

Note: If printing from enclosed software/driver, the software/driver will send out the commands, which will overwrite the settings set from the panel.

6.3.2 ZPL2

This "ZPL2" category can set up the printer settings for ZPL2.

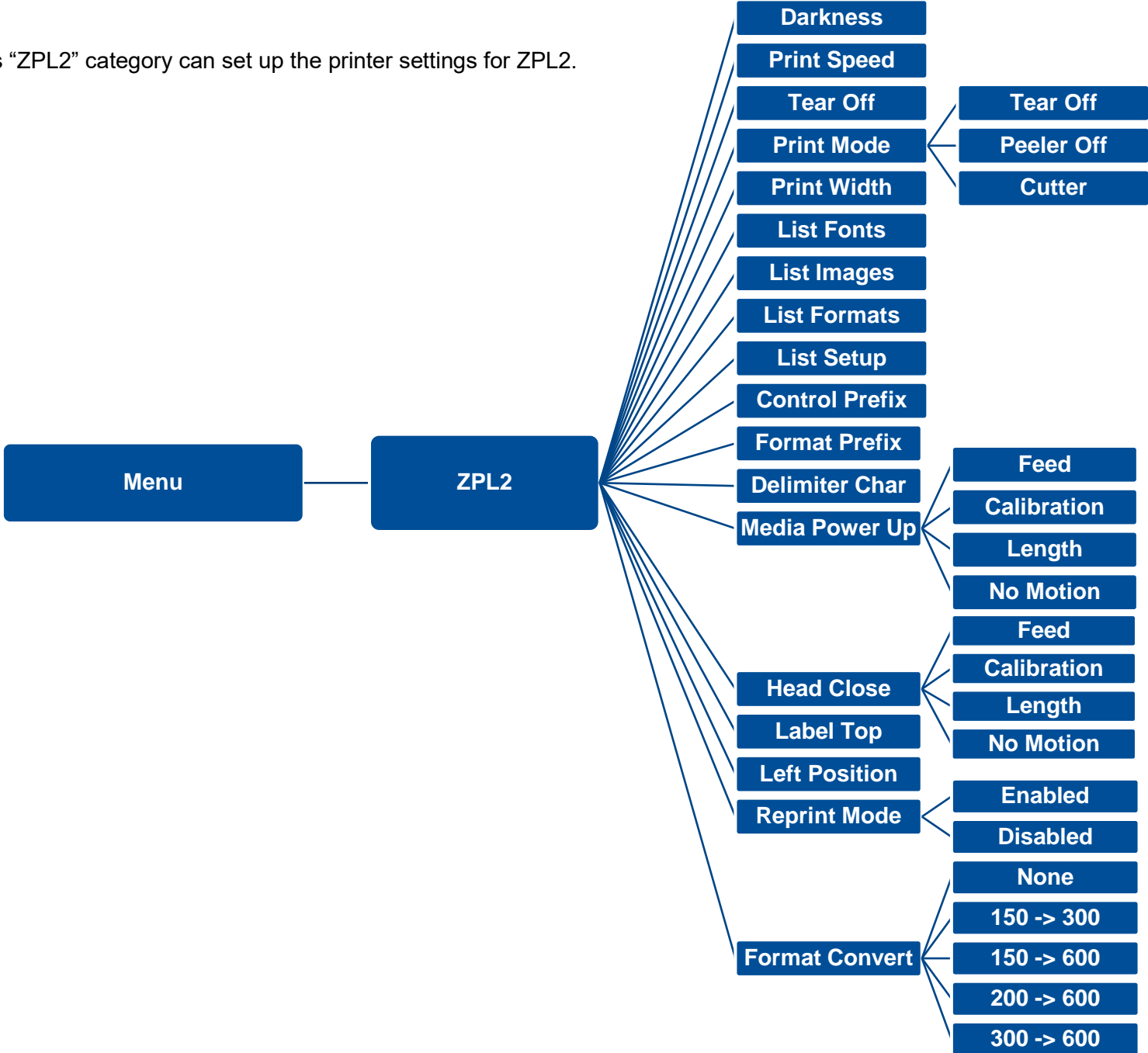

| Item | Description | Default |
|----------------|---|--------------------------|
| Density | Set the printing darkness. Available setting range: 0 to 30. | 16 |
| Print Speed | Set the print speed. Available setting range is 1~6 for 203dpi and 1~5 for 300dpi. | 203 dpi: 4 300 dpi: 3 |
| Tear Off | Adjust media stop location. Available setting value range: -120~120 dots. | 0 dot |
| Print mode | <p>Set the print mode. There are 4 modes:</p> <p>Tear Off: Next label top of form is aligned to the print head heating line location.</p> <p>Peeler Off: Enable the label peel off mode.</p> <p>Cutter: Enable the label cutter mode</p> | Tear Off |
| Print Width | Set the print width. Available setting range: 2 ~ 999 dots. | 1800 |
| List Fonts | Print the current fonts list from the memory devices to the label. | N/A |
| List Images | Print current printer available images list stored at the memory device to the label. | N/A |
| List Formats | Print current printer available formats list from the memory devices to the label. | N/A |
| List Setup | Print current printer configuration to the label. | N/A |
| Control Prefix | Set control prefix character. | N/A |
| Format Prefix | Set format prefix character. | N/A |
| Delimiter Char | Set delimiter character. | N/A |

| | | |
|--|--|------------------|
| Media Power Up | Set the action of the media when turning on the printer. | |
| | Feed: Printer will advance one label. | |
| | Calibration: Printer will make calibration. | No Motion |
| | Length: Printer determine length and feed label. | |
| Head Close | Set the action of the media when closing the print head. | |
| | Feed: Printer will advance one label. | |
| | Calibration: Printer will make calibration. | No Motion |
| | Length: Printer determine length and feed label. | |
| No Motion: Printer will not move media. | | |
| Label Top | Adjust print position vertically on the label. Value range: -120 to +120 dots. | 0 |
| Left Position | Adjust print position horizontally on the label. Value range:-9999 to +9999 dots. | 0 |
| Reprint Mode | Reprint the last label by pressing  button on printer's control panel. | Disabled |
| Format Convert | Select the bitmap scaling factor. The first number is the original dots per inch (dpi) value; the second the dpi which you would like to scale. | None |

Note: printing from other software/drive will overwrite the settings set from the panel.

6.4 Sensor

This option is used to calibrate the selected sensor. We recommend calibrate the sensor before printing when changing the media.

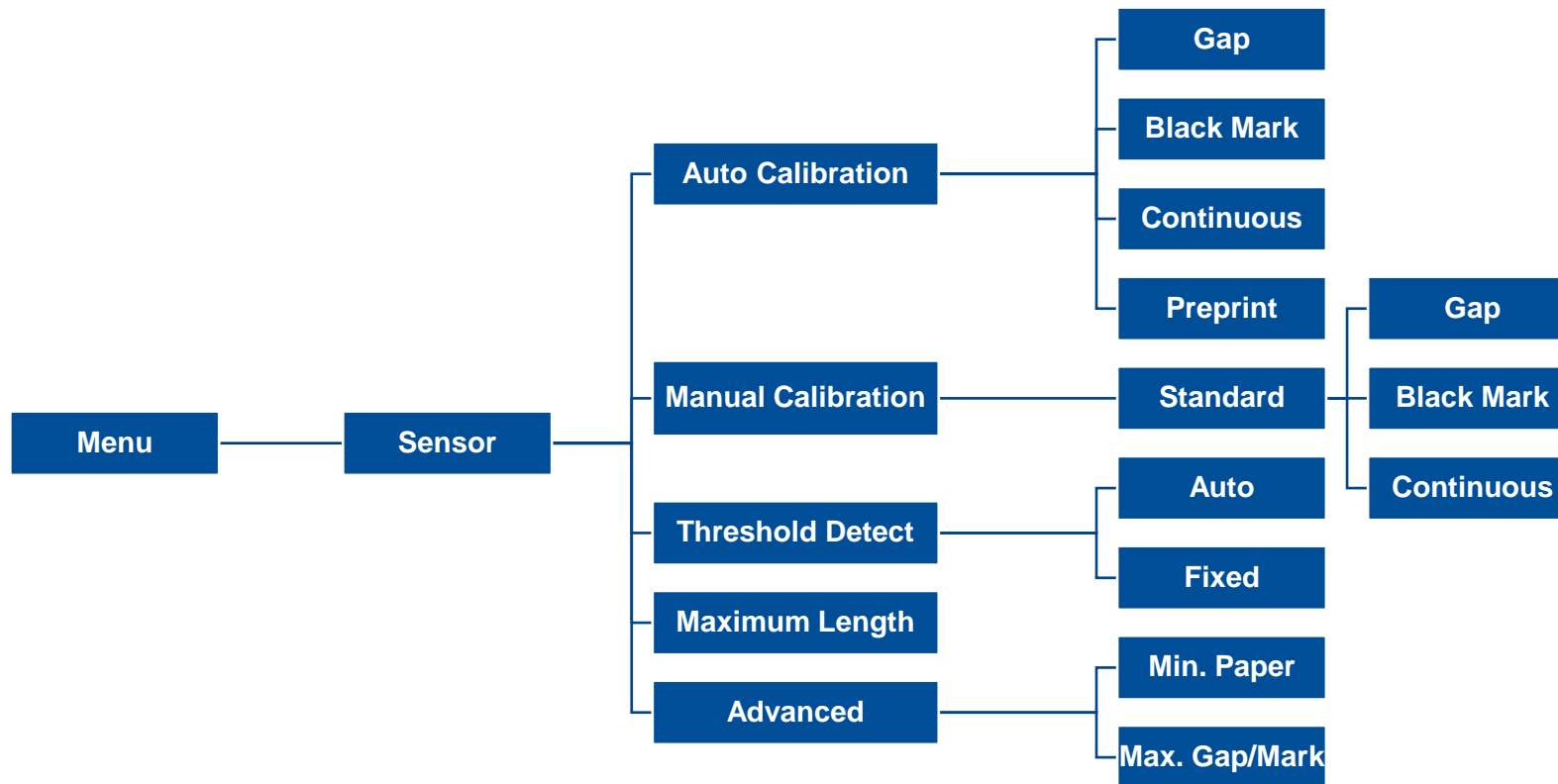

| Item | Description | Default |
|---------------------------|--|---------|
| Auto Calibration | Set the media sensor type and calibrate the selected sensor automatically. | N/A |
| Manual Calibration | In case Auto Calibration does not work, please use “Manual” function to set the paper length and gap/bline size to complete the calibration setting. | N/A |
| Threshold Detect | Set sensor sensitivity in fixed or auto. | Auto |
| Maximum Length | Set the maximum length for label calibration. | 254 mm |
| Advanced | Set the minimum paper length and maximum gap/bline length for auto-calibration. | 0 mm |

6.5 Interface

Interface can set the printer interface settings.

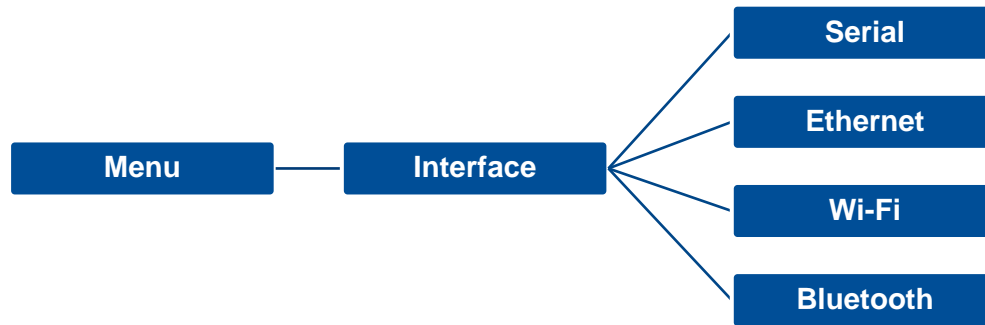

6.5.1 Serial Comm

Serial comm can set the printer RS-232 settings.

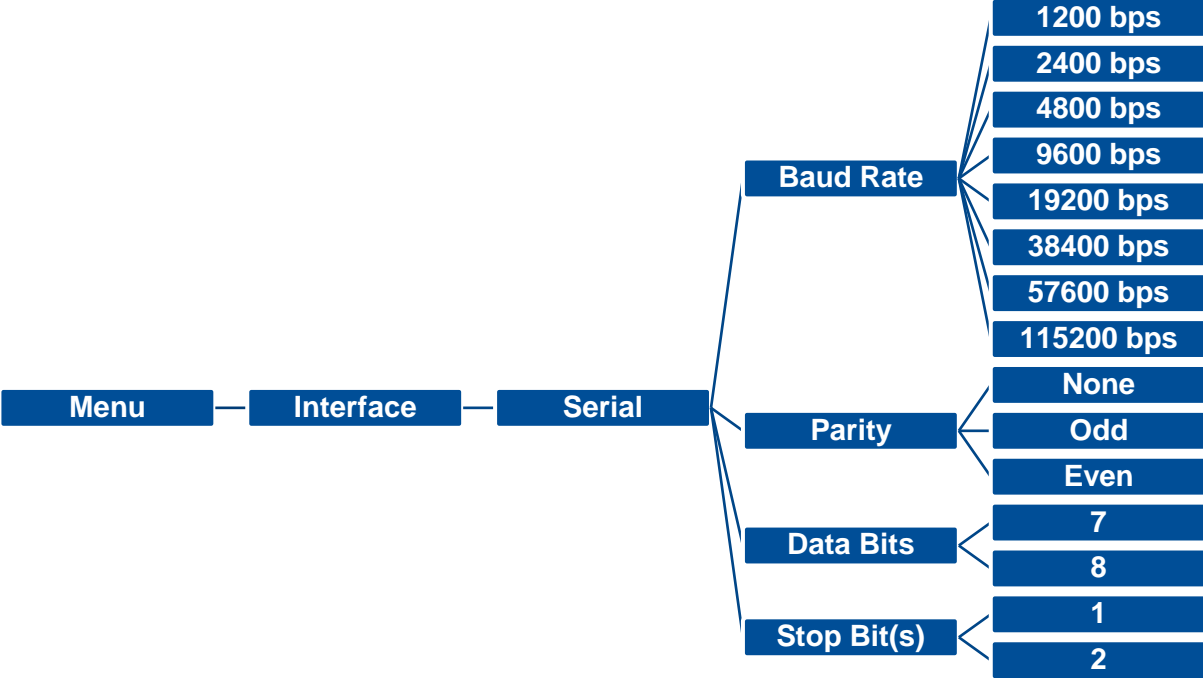

| Item | Description | Default |
|-------------|---------------------------|---------|
| Baud Rate | Set the RS-232 baud rate. | 9600 |
| Parity | Set the RS-232 parity. | None |
| Data Bits | Set the RS-232 Data Bits. | 8 |
| Stop Bit(s) | Set RS-232 Stop Bits. | 1 |

6.5.2 Ethernet

Ethernet configures internal Ethernet configuration and checks the printer's Ethernet module status, and reset the Ethernet module.

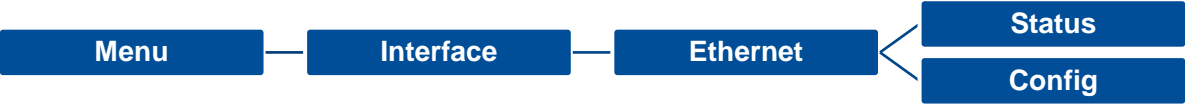

| Item | Description | Default |
|---------|--|---------|
| Status | Check the Ethernet IP address and MAC setting status. | N/A |
| Config. | DHCP: On or OFF the DHCP (Dynamic Host Configuration Protocol) network protocol. Static IP: Use this menu to set the printer's IP address, subnet mask and gateway. | DHCP |

6.5.3 Wi-Fi

Wi-Fi can set the printer Wi-Fi settings.

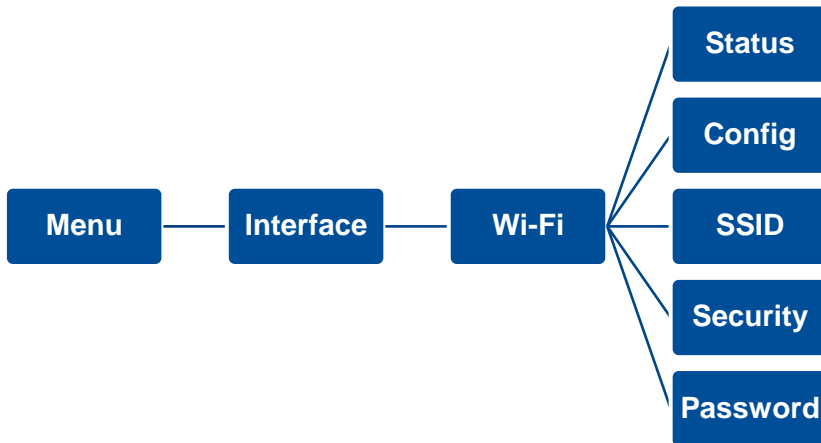

| Item | Description | Default |
|----------|--|---------|
| Status | Check the Wi-Fi IP address, MAC setting status,...etc. | N/A |
| Config. | DHCP: ON/OFF the DHCP (Dynamic Host Configuration Protocol) network protocol. Static IP: Set the printer's IP address, subnet mask and gateway. | DHCP |
| SSID | Set Wi-Fi SSID. | N/A |
| Security | Set Wi-Fi security. | Open |
| Password | Set Wi-Fi password. | N/A |

6.5.4 Bluetooth

Bluetooth can set the printer Bluetooth settings.

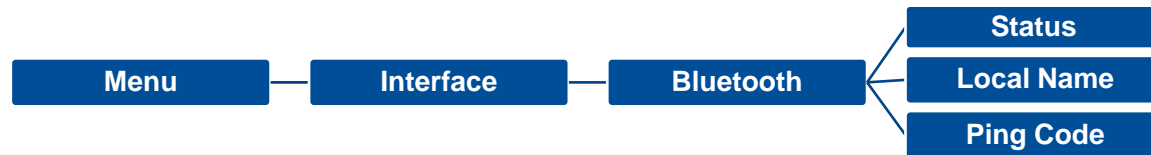

| Item | Description | Default |
|------------|--|---------|
| Status | Check the Bluetooth status. | N/A |
| Local Name | Set the local name for Bluetooth. | RF-BHS |
| Ping Code | Set the local ping code for Bluetooth. | 0000 |

6.6 Advanced

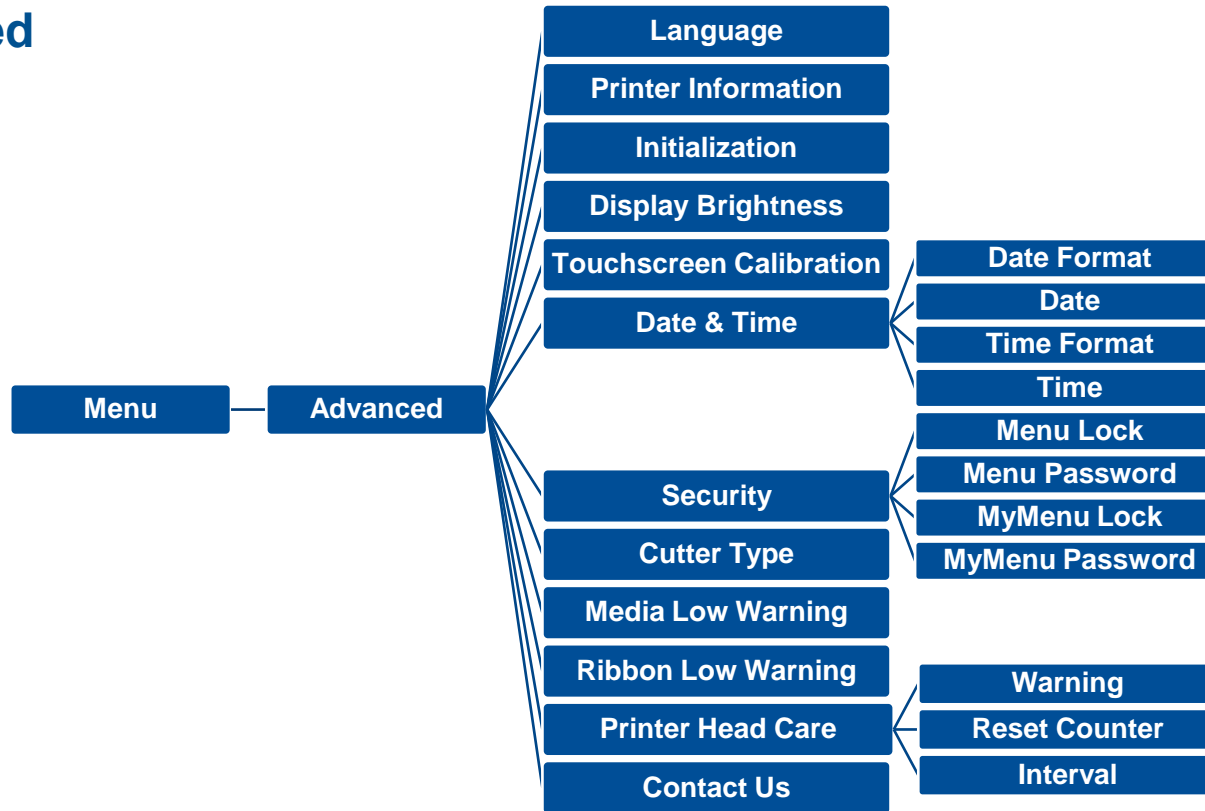

| Item | Description | Default |
|-------------------------|---|---------|
| Language | Switch the language on display. | English |
| Printer Information | Check the printer's serial number, printed mileage (m), printed labels (pcs) and cutting counter. | N/A |
| Initialization | Restore printer settings to defaults. | N/A |
| Display Brightness | Set the brightness for display. Range: 0~100. | 50 |
| Touchscreen Calibration | Calibrate the touchscreen for best result. | N/A |

| | | |
|----------------------------|---|-------------------|
| Date & Time | Setup the date and time on display. | N/A |
| Security | Set the password for locking the menu or favorites. The default password is 8888. | Disable |
| Cutter Type | Set the cutter type. | Guillotine |
| Ribbon Low Warning | Set the warning for ribbon low. For example, if setting value is 30m, when ribbon capacity was lower than 30m, the  will be shown in red. | 30M |
| | Check print head status and to set the settings for print head care. | |
| | Warning: Enable/disable the print head clean warning. If enable this feature, once print head has been reached the setting mileage then the warning icon will be shown on printer UI for reminding user to clean the print head. The default setting is disable. | |
| Printer Head Maintn | Reset Counter: Reset the print head clean warning mileage after cleaning print head. | N/A |
| | Interval: This item is used to set the expected mileage for reminding user to clean the print head. You have to enable the “TPH warning lock” for use. The default setting is 1 km. | |
| | Key sound: This item is used to enable/disable the sound of front panel buttons. | |
| Contact us | Check the contact information for tech support service | N/A |

6.7 File Manager

File Manager is used to check the printer available memory, show the files list, delete the files or run the files that saved in the printer DRAM/Flash/Card memory.



6.8 Diagnostic

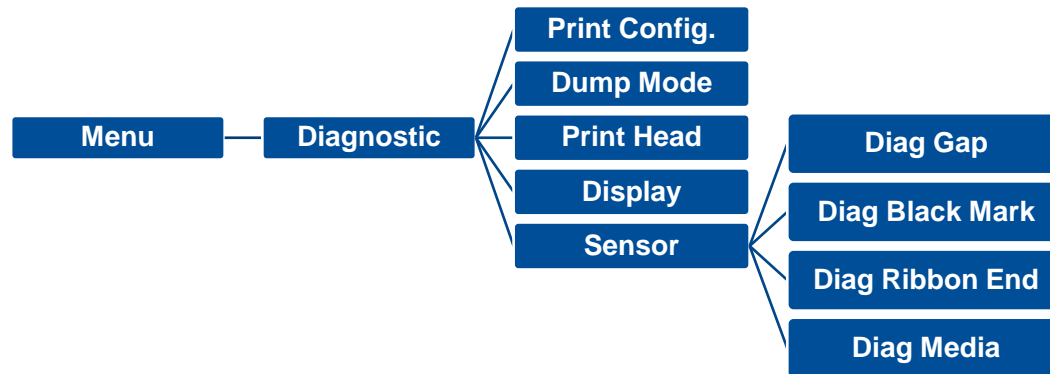

```

DOWNLOA 0D 0A 44 4F 57 4E 4C 4F 4I
D „TEST2. 44 20 22 54 45 53 54 32 2E
DAT“,5,CL 44 41 54 22 2C 35 2C 43 4C
S DOWNLO 53 0D 0A 44 4F 57 4E 4C 4F
AD F,“TES 41 44 20 46 2C 22 54 45 53
T4.DAT“,5 54 34 2E 44 41 54 22 2C 35
,CLS DOW 2C 43 4C 53 0D 0A 44 4F 57
NLOAD „TE 4E 4C 4F 41 44 20 22 54 45
ST2.DAT“, 53 54 32 2E 44 41 54 22 2C
5,CLS DO 35 2C 43 4C 53 0D 0A 44 4F
WNLOAD F, 57 4E 4C 4F 41 44 20 46 2C
„TEST4.DA 22 54 45 53 54 34 2E 44 41
T“,5,CLS 54 22 2C 35 2C 43 4C 53 0D
DOWNLOAD 0A 44 4F 57 4E 4C 4F 41 44
“TEST2.D 20 22 54 45 53 54 32 2E 44
AT“,5,CLS 41 54 22 2C 35 2C 43 4C 53
DOWNLOA 0D 0A 44 4F 57 4E 4C 4F 4I
D F,“TEST 44 20 46 2C 22 54 45 53 54
4.DAT“,5, 34 2E 44 41 54 22 2C 35 2C
CLS 43 4C 53 0D 0A
  
```

Item

Description

Print Config.

Print current printer configuration to the label. The configuration printout contains print head test pattern, which is useful for checking the dot damage on the print head heater.

Dump Mode

Captures the data from the communications port and prints out the data received by printer. In the dump mode, all characters will be printed in 2 columns. The left side characters are received from your system and right side data are the corresponding hexadecimal value of the characters. It allows users or engineers to verify and debug the program.

Dump mode requires 4” wide paper width.

Print Head

Check print head’s temperature and bad dots.

Display

Check LCD’s color state.

Sensor

Check sensors intensity and reading state.

6.9 Favorites

Favorites helps users build a commonly used list. Arrange the commonly used setting options by **Favorites** .

Add items: Touch and hold the item > window of **Join Favorites** will pop up > tap **Yes** to add the item to **Favorites**.

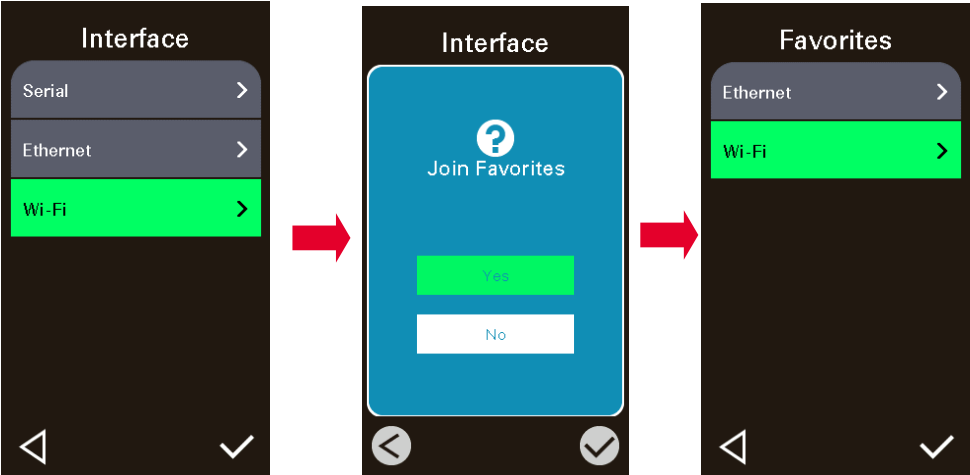

Delete items: Touch and hold the item > window of **Delete Favorites** will pop up > tap **Yes** to delete the item.

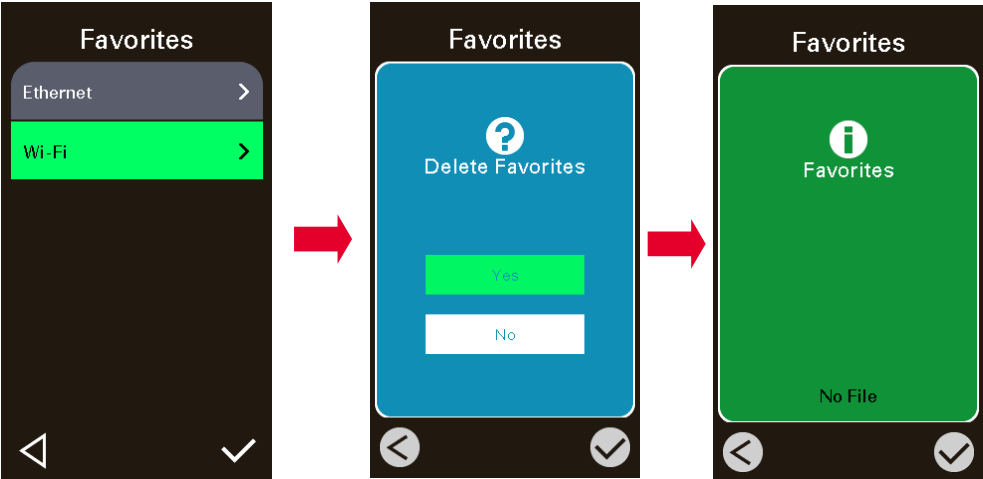

7. Troubleshooting

| Problem | Possible Cause | Recovery Procedure |
|--|---|---|
| Power indicator does not illuminate | <ul style="list-style-type: none"> ■ The power cord is not properly connected. ■ The power switch is closed. | <ul style="list-style-type: none"> ■ Plug the power cord in printer and outlet. ■ Switch the printer on. |
| Carriage Open | <ul style="list-style-type: none"> ■ The printer carriage is open. | <ul style="list-style-type: none"> ■ Close the print carriage. |
| Not Printing | <ul style="list-style-type: none"> ■ Check if interface cable is well connected. ■ Check if wireless or Bluetooth device is well connected. ■ The port in the Windows driver is not correct. | <ul style="list-style-type: none"> ■ Re-connect cable to interface or change a new cable. ■ Reset the wireless device setting. ■ Select the correct printer port in the driver. ■ Clean the printhead. ■ Printhead's harness connector is not well connected with printhead. Turn off the printer and plug the connector again. ■ Check your program if there is a command - PRINT at the end of the file and there must have CRLF at the end of each command line. |
| No print on the label | <ul style="list-style-type: none"> ■ Label or ribbon is loaded not correctly. ■ Use wrong type paper or ribbon | <ul style="list-style-type: none"> ■ Follow the instructions in loading the media and ribbon. ■ Ribbon and media are not compatible. ■ Verify the ribbon-inked side. ■ The print density setting is incorrect. |
| No Ribbon | <ul style="list-style-type: none"> ■ Running out of ribbon. ■ The ribbon is installed incorrectly. | <ul style="list-style-type: none"> ■ Supply a new ribbon roll. ■ Refer to user's manual to reinstall the ribbon. |
| No Paper | <ul style="list-style-type: none"> ■ Running out of label. ■ The label is installed incorrectly. ■ Gap/black mark sensor is not calibrated. | <ul style="list-style-type: none"> ■ Supply a new label roll. ■ Refer to user's manual to reinstall the label roll. ■ Calibrate the gap/black mark sensor. |
| Paper Jam | <ul style="list-style-type: none"> ■ Gap/black mark sensor is not set properly. ■ Make sure label size is set properly. ■ Labels may be stuck inside the printer | <ul style="list-style-type: none"> ■ Calibrate the media sensor. ■ Set media size correctly. ■ Remove the stuck label inside the printer mechanism. |

| | | | |
|---|---|------------|--|
| | | mechanism. | |
| Take Label | <ul style="list-style-type: none"> ■ Peel function is enabled. | | <ul style="list-style-type: none"> ■ If peeler module is installed, please remove the label. ■ If there is no peeler module in front of the printer, please switch off the printer and install it. ■ Check if the connector is plugging correctly. |
| Can't downloading the file to memory (FLASH / DRAM/CARD) | <ul style="list-style-type: none"> ■ The space of memory is full. | | <ul style="list-style-type: none"> ■ Delete unused files in the memory. |
| Poor Print Quality | <ul style="list-style-type: none"> ■ Ribbon and media is loaded incorrectly. ■ Dust or adhesive accumulation on the print head. ■ Print density is not set properly. ■ Printhead element is damaged. ■ Ribbon and media are incompatible. ■ The printhead pressure is not set properly. | | <ul style="list-style-type: none"> ■ Reload the supply. ■ Clean the print head. ■ Clean the platen roller. ■ Adjust the print density and print speed. ■ Run printer self-test and check the print head test pattern if there is dot missing in the pattern. ■ Change proper ribbon or proper label media. ■ Adjust the printhead pressure adjustment knob. ■ The release lever does not latch the printhead properly. |
| Missing printing on the left or right side of label | <ul style="list-style-type: none"> ■ Wrong label size setup. | | <ul style="list-style-type: none"> ■ Set the correct label size. |
| Gray line on the blank label | <ul style="list-style-type: none"> ■ The print head is dirty. ■ The platen roller is dirty. | | <ul style="list-style-type: none"> ■ Clean the print head. ■ Clean the platen roller. ■ (Please refer to chapter 8) |
| Irregular printing | <ul style="list-style-type: none"> ■ The printer is in Hex Dump mode. ■ The RS-232 setting is incorrect. | | <ul style="list-style-type: none"> ■ Turn off and on the printer to skip the dump mode. ■ Re-set the RS-232 setting. |
| Label feeding is not stable (skew) when printing | <ul style="list-style-type: none"> ■ The media guide does not touch the edge of the media. | | <ul style="list-style-type: none"> ■ If the label is moving to the right side, please move the label guide to left. ■ If the label is moving to the left side, please move the label guide to right. |
| Skip labels when printing | <ul style="list-style-type: none"> ■ Label size is not specified properly. | | <ul style="list-style-type: none"> ■ Check if label size is setup correctly. |

| | | |
|---|---|--|
| | <ul style="list-style-type: none"> ■ Sensor sensitivity is not set properly. ■ The media sensor is covered with dust. | <ul style="list-style-type: none"> ■ Calibrate the sensor by Auto Gap or Manual Gap options. ■ Clear the GAP/Black mark sensor by blower. |
| <p>Wrinkle Problem</p> | <ul style="list-style-type: none"> ■ Printhead pressure is incorrect. ■ Ribbon installation is incorrect. ■ Media installation is incorrect. ■ Print density is incorrect. ■ Media feeding is incorrect. | <ul style="list-style-type: none"> ■ Please refer to the chapter 4. ■ Please set the suitable density to have good print quality. ■ Make sure the label guide touch the edge of the media guide. |
| <p>RTC time is incorrect when reboot the printer</p> | <ul style="list-style-type: none"> ■ The battery has run down. | <ul style="list-style-type: none"> ■ Check if there is a battery on the main board. |
| <p>The left side printout position is incorrect</p> | <ul style="list-style-type: none"> ■ Wrong label size setup. ■ The parameter Shift X in LCD menu is incorrect. | <ul style="list-style-type: none"> ■ Set the correct label size. ■ Press [Menu] → [Setting] → [Shift X] to fine tune the parameter of Shift X. |
| <p>The printing position of small label is incorrect</p> | <ul style="list-style-type: none"> ■ Media sensor sensitivity is not set properly. ■ Label size is incorrect. ■ The parameter Shift Y in the LCD menu is incorrect. ■ The vertical offset setting in the driver is incorrect. | <ul style="list-style-type: none"> ■ Calibrate the sensor sensitivity again. ■ Set the correct label size and gap size. ■ Press [Menu] → [Setting] → [Shift Y] → to fine tune the parameter of Shift Y. ■ Set the vertical offset in the driver if you're using BarTender. |

8. Maintenance

This session presents the clean tools and methods to maintain the printer.

■ For Cleaning

Depending on the media used, the printer may accumulate residues (media dust, adhesives, etc.) as a by-product of normal printing. To maintain the best printing quality, you should remove these residues by cleaning the printer periodically. Regularly clean the print head and supply sensors once change a new media to keep the printer at the optimized performance and extend printer life.

■ For Disinfecting

Sanitize your printer to protect yourself and others and can help prevent the spread of viruses.

■ Important

- Set the printer power switch to O (Off) prior to performing any cleaning or disinfecting tasks. Leave the power cord connected to keep the printer grounded and to reduce the risk of electrostatic damage.
- Do not wear rings or other metallic objects while cleaning any interior area of the printer.
- Use only the cleaning agents recommended in this document. Use of other agents may damage the printer and void its warranty.
- Do not spray or drip liquid cleaning solutions directly into the printer. Apply the solution on a clean lint-free cloth and then apply the dampened cloth to the printer.
- Do not use canned air in the interior of the printer as it can blow dust and debris onto sensors and other critical components.
- Only use a vacuum cleaner with a nozzle and hose that are conductive and grounded to drain off static build up.
- All reference in these procedures for use of isopropyl alcohol requires that a 99% or greater isopropyl alcohol content be used to reduce the risk of moisture corrosion to the printhead.
- Do not touch printhead by hand. If you touch it carelessly, please use 99% Isopropyl alcohol to clean it.
- Always taking personal precaution when using any cleaning agent.

Cleaning Tools

- Cotton swab
- Lint-free cloth
- Brush with soft non-metallic bristles
- Vacuum cleaner
- 75% Ethanol (for disinfecting)
- 99% Isopropyl alcohol (for printhead and platen roller cleaning)
- Genuine printhead cleaning pen
- Mild detergent (without chlorine)

Cleaning Process:

| Printer Part | Method | Interval |
|----------------------|---|--|
| Print Head | <ol style="list-style-type: none"> I. Always turn off the printer before cleaning the printhead. II. Allow the printhead to cool for at least one minute. III. Use a cotton swab and 99% Isopropyl Alcohol or genuine print head cleaning pen to clean the print head surface. | Clean the print head when changing a new label roll. |
| Platen Roller | <ol style="list-style-type: none"> I. Turn off the printer. II. Rotate the platen roller and wipe it thoroughly with the lint-free 99% Isopropyl Alcohol. | Clean the platen roller when changing a new label roll |
| Peel Bar | Use the lint-free cloth with 99% Isopropyl Alcohol to wipe it. | As needed |
| Sensor | Use brush with soft non-metallic bristles or a vacuum cleaner, to remove paper dust. Clean upper and lower media sensors to ensure reliable Top of Form and Paper Out sensing. | Monthly |
| Exterior | Clean the exterior surfaces with a clean, lint-free cloth (water-dampened cloth). If necessary, use a mild detergent or desktop cleaning solution then use the 75% Ethanol to wipe it. | As needed |
| Interior | Clean the interior of the printer by removing any dirt and lint with a vacuum cleaner, as described above, or use a brush with soft non-metallic bristles then use the 75% Ethanol to wipe it. | As needed |

9. Agency Compliance and Approvals



EN 55032, Class A
EN 55035
EN 60950-1

This is a class A product. In a domestic environment this product may cause radio interference in which case the user may be required to take adequate measures.



FCC part 15B, Class A
ICES-003, Class A

This equipment has been tested and found to comply with the limits for a Class A digital device, pursuant to Part 15 of the FCC Rules. These limits are designed to provide reasonable protection against harmful interference when the equipment is operated in a commercial environment.

This equipment generates, uses, and can radiate radio frequency energy and, if not installed and used in accordance with the manufacturer's instruction manual, may cause harmful interference with radio communications. Operation of this equipment in a residential area is likely to cause harmful interference, in which case you will be required to correct the interference at your own expense.

This Class A digital apparatus complies with Canadian ICES-003.

Cet appareil numérique de la classe A est conform à la norme NMB-003 du Canada.

This device complies with Part 15 of the FCC Rules. Operation is subject to the following two conditions: (1) This device may cause harmful interference, and (2) this device must accept any interference received, including interference that may cause undesired operation.



AS/NZS CISPR 32, Class A

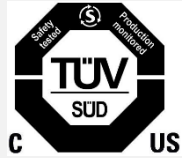

UL 62368-1
CSA C22.2 No. 62368-1



EN 62368-1



KN 32 / KN 35 / K 60950-1

이 기기는 업무용(A 급) 전자파적합기기로서 판매자 또는 사용자는 이 점을 주의하시기 바라며, 가정외의 지역에서 사용하는 것을 목적으로 합니다.



GB 4943.1
GB/T9254, Class A
GB 17625.1

此为 A 级产品，在生活环境中，该产品可能会造成无线电干扰，
在这种情况下，可能需要用户对干扰采取切实可行的措施。



Energy Star for Imaging Equipment Version 2.0



IS 13252(Part 1)/
IEC 60950-1



CNS 13438
CNS 14336-1
CNS 15663



LP0002

Note: There may have certification differences in the series models, please refer to product label for accuracy.

Important safety instructions:

1. Read all of these instructions and keep them for later use.
2. Follow all warnings and instructions on the product.
3. Disconnect the power plug from the AC outlet before cleaning or if fault happened.
Do not use liquid or aerosol cleaners. Using a damp cloth is suitable for cleaning.
4. The mains socket shall be installed near the equipment and easily accessible.
5. The unit must be protected against moisture.
6. Ensure the stability when installing the device, Tipping or dropping could cause damage.
7. Make sure to follow the correct power rating and power type indicated on marking label provided by manufacture.
8. Please refer to user manual for maximum operation ambient temperature.

WARNING:

Hazardous moving parts, keep fingers and other body parts away.

CAUTION:

(For equipment with RTC (CR2032) battery or rechargeable battery pack)

Risk of explosion if battery is replaced by an incorrect type.

Dispose of used batteries according to the Instructions as below.

1. DO NOT throw the battery in fire.
2. DO NOT short circuit the contacts.
3. DO NOT disassemble the battery.
4. DO NOT throw the battery in municipal waste.
5. The symbol of the crossed out wheeled bin indicates that the battery should not be placed in municipal waste.



Caution: The printhead may be hot and could cause severe burns. Allow the printhead to cool.

WARNING:

For operation safety, please turn off the power by the power switch before opening the media cover to load labels, ribbons, or to repair. After

completing the steps, please close the media cover first and then turn on the power to start printing.

CAUTION:

Any changes or modifications not expressly approved by the grantee of this device could void the user's authority to operate the equipment.

Below statement are for product with optional RF function.

CE Statement:

This equipment complies with EU radiation exposure limits set forth for an uncontrolled environment. This equipment should be installed and operated with minimum distance 20 cm between the radiator & your body.

All operational modes:

2.4GHz: 802.11b, 802.11g, 802.11n (HT20), 802.11n (HT40)

5GHz: 802.11a,

The frequency, mode and the maximum transmitted power in EU are listed below:

2400 MHz – 2483.5 MHz: 19.88 dBm (EIRP)(Wi-Fi)

5150 MHz – 5250 MHz: 17.51 dBm (EIRP)(Wi-Fi)

2402 MHz – 2480 MHz: 6.02 dBm (EIRP)(Bluetooth)

Requirements in AT/BE/BG/CZ/DK/EE/FR/DE/IS/IE/IT/EL/ES/CY/LV/LI/LT/LU/HU/MT/NL/NO/PL/PT/RO/SI/SK/TR/FI/SE/CH/UK/HR.

5150MHz~5350MHz is for indoor use only.

5150-5350MHz for Only indoor use

5470-5725MHz for indoor/outdoor use



Restrictions In AZE

National restrictions information is provided below

| Frequency Band | Country | Remark |
|----------------|------------|--------------------------------------|
| 5150-5350MHz | Azerbaijan | No license needed if used indoor and |

| | |
|--------------|--------------------------|
| 5470-5725MHz | power not exceeding 30mW |
|--------------|--------------------------|

Hereby, TSC Auto ID Technology Co., Ltd. declares that the radio equipment type [Wi-Fi] IEEE 802.11 a/b/g/n is in compliance with Directive 2014/53/EU

The full text of the EU declaration of conformity is available at the following internet address: <https://www.tscprinters.com/EN/support>

Canada, Industry Canada (IC) Notices

This Class B digital apparatus complies with Canadian ICES-003 and RSS-210.

Operation is subject to the following two conditions: (1) this device may not cause interference, and (2) this device must accept any interference, including interference that may cause undesired operation of the device.

Canada, avis de l'Industry Canada (IC)

Cet appareil numérique de classe B est conforme aux normes canadiennes ICES-003 et RSS-210.

Son fonctionnement est soumis aux deux conditions suivantes : (1) cet appareil ne doit pas causer d'interférence et (2) cet appareil doit accepter toute interférence, notamment les interférences qui peuvent affecter son fonctionnement.

NCC 警語:

經型式認證合格之低功率射頻電機，非經許可，公司、商號或使用者均不得擅自變更頻率、加大功率或變更原設計之特性及功能。(即低功率電波

輻射性電機管理辦法第十二條)

低功率射頻電機之使用不得影響飛航安全及干擾合法通信；經發現有干擾現象時，應立即停用，並改善至無干擾時方得繼續使用。

前項合法通信，指依電信法規定作業之無線電通信。低功率射頻電機須忍受合法通信或工業、科學及醫療用電波輻射性電機設備之干擾。(即低功

率電波輻射性電機管理辦法第十四條)

BSMI Class A 警語:

這是甲類的資訊產品，在居住的環境使用中時，可能會造成射頻干擾，在這種情況下，使用者會被要求採取某些適當的對策。

MFi for Bluetooth



Use of the Made for Apple badge means that an accessory has been designed to connect specifically to the Apple product(s) identified in the badge, and has been certified by the developer to meet Apple performance standards. Apple is not responsible for the operation of this device or its compliance with safety and regulatory standards.

For US Model

Made for iPhone®XS Max, iPhone XS, iPhone XR, iPhone X, iPhone 8, iPhone 8 Plus, iPhone 7, iPhone 7 Plus, iPhone SE, iPhone 6s, iPhone 6s Plus, iPhone 6, iPhone 6 Plus, iPhone 5s, iPad Pro® 12.9-inch (2nd generation), iPad Pro 10.5-inch, iPad® (6th generation), iPad (5th generation), iPad Pro 9.7-inch, iPad Pro 12.9-inch (1st generation), iPad Air® 2, iPad mini™ 4, iPad mini 3, iPad Air, iPad mini 2, iPod touch® (6th generation)

iPad, iPad Air, iPad Pro, iPhone are trademarks of Apple Inc., registered in the U.S. and other countries.

For JP Model

Made for iPhone XS Max, iPhone XS, iPhone XR, iPhone X, iPhone 8, iPhone 8 Plus, iPhone 7, iPhone 7 Plus, iPhone SE, iPhone 6s, iPhone 6s Plus, iPhone 6, iPhone 6 Plus, iPhone 5s, iPad Pro 12.9-inch (2nd generation), iPad Pro 10.5-inch, iPad (6th generation), iPad (5th generation),

iPad Pro 9.7-inch, iPad Pro 12.9-inch (1st generation), iPad Air 2, iPad mini 4, iPad mini 3, iPad Air, iPad mini 2, iPod touch (6th generation)

iPad, iPad Air, iPad Pro, iPhone are trademarks of Apple Inc., registered in the U.S. and other countries. The trademark “iPhone” is used in Japan with a license from Aiphone K.K.

Except for US, JP Model

Made for iPhone XS Max, iPhone XS, iPhone XR, iPhone X, iPhone 8, iPhone 8 Plus, iPhone 7, iPhone 7 Plus, iPhone SE, iPhone 6s, iPhone 6s Plus, iPhone 6, iPhone 6 Plus, iPhone 5s, iPad Pro 12.9-inch (2nd generation), iPad Pro 10.5-inch, iPad (6th generation), iPad (5th generation), iPad Pro 9.7-inch, iPad Pro 12.9-inch (1st generation), iPad Air 2, iPad mini 4, iPad mini 3, iPad Air, iPad mini 2, iPod touch (6th generation)

iPad, iPad Air, iPad Pro, iPhone are trademarks of Apple Inc., registered in the U.S. and other countries.

| 單元Unit | 限用物質及其化學符號 Restricted substances and its chemical symbols | | | | | |
|------------|--|------------------|------------------|--|--|---|
| | 鉛Lead (Pb) | 汞Mercury (Hg) | 鎘Cadmium (Cd) | 六價鉻Hexavalent chromium (Cr ⁺⁶) | 多溴聯苯 Polybrominated biphenyls (PBB) | 多溴二苯醚 Polybrominated diphenyl ethers (PBDE) |
| 內外塑膠件 | ○ | ○ | ○ | ○ | ○ | ○ |
| 內外鐵件 | - | ○ | ○ | ○ | ○ | ○ |
| 滾輪 | ○ | ○ | ○ | ○ | ○ | ○ |
| 銘版 | ○ | ○ | ○ | ○ | ○ | ○ |
| 電路板 | - | ○ | ○ | ○ | ○ | ○ |
| 晶片電阻 | - | ○ | ○ | ○ | ○ | ○ |
| 積層陶瓷表面黏著電容 | ○ | ○ | ○ | ○ | ○ | ○ |
| 集成電路-IC | - | ○ | ○ | ○ | ○ | ○ |
| 電源供應器 | ○ | ○ | ○ | ○ | ○ | ○ |
| 印字頭 | - | ○ | ○ | ○ | ○ | ○ |
| 馬達 | - | ○ | ○ | ○ | ○ | ○ |
| 液晶顯示器 | - | ○ | ○ | ○ | ○ | ○ |
| 插座 | - | ○ | ○ | ○ | ○ | ○ |
| 線材 | - | ○ | ○ | ○ | ○ | ○ |

備考 1. “超出 0.1 wt %” 及 “超出 0.01 wt %” 係指限用物質之百分比含量超出百分比含量基準值。

Note 1 : “Exceeding 0.1 wt %” and “exceeding 0.01 wt %” indicate that the percentage content of the restricted substance exceeds the reference percentage value of presence condition.

備考 2. “○” 係指該項限用物質之百分比含量未超出百分比含量基準值。

Note 2 : “○” indicates that the percentage content of the restricted substance does not exceed the percentage of reference value of presence.

備考 3. “-” 係指該項限用物質為排除項目。

Note 3 : The “-” indicates that the restricted substance corresponds to the exemption.

10. Revision History

| Date | Content | Editor |
|------------|--|-----------|
| 2023/08/10 | Removed CD disk from the packing list, page 8. | Peter Yao |

TSC **PRINTRONIX®**
AUTO ID