

Industrial Barcode Printers

# MB240 Series

*Thermal Transfer • Direct Thermal*

## Series Models

MB240 / MB340

MB240T / MB340T



User Manual

# Copyright Information

**©2023 TSC Auto ID Technology Co., Ltd.**

The copyright in this manual, the software and firmware in the printer described are owned by TSC Auto ID Technology Co., Ltd. All rights reserved.

CG Triumvirate is a trademark of Agfa Corporation. CG Triumvirate Bold Condensed font is under license from the Monotype Corporation. Windows is a registered trademark of Microsoft Corporation.

All other trademarks are the property of their respective owners. Information in this document is subject to change without notice and does not represent a commitment on the part of TSC Auto ID Technology Co. No part of this manual may be reproduced or transmitted in any form or by any means, for any purpose other than the purchaser's personal use, without the expressed written permission of TSC Auto ID Technology Co.



# Table of Contents

<b>1 Introduction</b>	<b>1</b>
1.1 Product Specification	2
<b>2 Operation Overview</b>	<b>5</b>
2.1 Unpacking and Inspection	5
2.2 Printer Overview	6
2.3 Operator Control	9
<b>3 Setup</b>	<b>14</b>
3.1 Setting up the Printer	14
3.2 Loading the Ribbon	15
3.3 Loading the Media	17
3.4 Loading the Fanfold/External Media	19
3.5 Loading Media in Peel-off Mode (Optional)	20
3.6 Loading Media in Cutter Mode (Optional)	22
3.7 Loading the Linerless Media (Optional)	23
<b>4 Knob Adjustment</b>	<b>27</b>
4.1 Ribbon Tension Adjustment Knob	28
4.2 Mechanism Fine Adjustment to Avoid Ribbon Wrinkles	29
<b>5 TSC Console</b>	<b>32</b>
5.1 Start TSC Console	32
5.2 Setup Ethernet Interface	34
5.3 Set Wi-Fi and Add to TSC Console Interface	36
5.4 Initialize the Printer WIFI Setting	39
5.5 Printer Function	40
5.6 Setting Post-Print Action	41
<b>6 LCD Menu Function</b>	<b>42</b>
6.1 Enter the Menu	42

6.2 Menu Overview .....	43
6.3 Setting.....	44
6.4 Sensor .....	50
6.5 Interface.....	51
6.6 Advanced.....	56
6.7 File Manager .....	59
6.8 Diagnostic .....	60
6.9 Favorites .....	61
6.10 Configuring the Printer and Setting Options for the Linerless Media.....	62
<b>7 Troubleshooting .....</b>	<b>65</b>
<b>8 Maintenance.....</b>	<b>69</b>
<b>9 Agency Compliance and Approvals .....</b>	<b>72</b>
<b>10 Revision History .....</b>	<b>80</b>

# 1 Introduction

TSC MB240 series of industrial thermal label printers is the new value leader for 4" wide light industrial label printing. The MB240 features a small footprint, easily understandable operator interface and a full set of options to meet nearly every printing application. Its compact design, quiet operation and fast label throughput is equally at home, in the office or on the shop floor. The printer's all-metal construction and die-cast aluminum print mechanism engine is durable enough to withstand the toughest production environments and is designed for years of trouble-free use.

This manual provides the essential information and clear instructions for operating MB240 series. To print label formats, please refer to the instructions provided with your labeling software. TSC printers include the Windows labeling software for creating your label template. For system integration, the TSPL/TSPL2 printer programming manual or SDKs can be found on TSC website at <https://www.tscprinters.com>

## Applications

- Work In Process
- Product Marking
- Compliance Labeling
- Industrial-Duty Printing
- Packing
- Order Fulfillment
- Shipping/Receiving
- Inventory Management Retail
- Product Label
- Event Ticketing

## 1.1 Product Specification

Model	MB240	MB340	MB240T	MB340T
<b>Resolution</b>	8 dots/mm (203 dpi)	12 dots/mm (300 dpi)	8 dots/mm (203 dpi)	12 dots/mm (300 dpi)
<b>Printing method</b>	Thermal Transfer & Direct Thermal			
<b>Max. print speed</b>	304.8mm (12")/second	228.6mm (9")/second	304.8mm (12")/second	228.6mm (9")/second
<b>Max. print width</b>	107mm (4.25")	105.7mm (4.16")	107mm (4.25")	105.7mm (4.16")
<b>Max. print length</b>	25,400mm (1000")	11,430mm (450")	25,400mm (1000")	11,430mm (450")
<b>Enclosure</b>	Die-cast based print mechanism/Metal cover with large clear media view window			
<b>Physical dimension</b>	248mm (W) x 274mm (H) x 436mm (D) 9.76" (W) x 10.79" (H) x 17.17" (D)			
<b>Weight</b>	9 kg (19.84 lbs.)		9.2 kg (20.28 lbs.)	
<b>Label roll capacity</b>	203.2mm (8") O.D.			
<b>Ribbon</b>	450m long, max. O.D. 81.3mm, 1" core (ink coated outside or inside)			
<b>Ribbon width</b>	40 to 110mm (1.6" to 4.3")			
<b>Processor</b>	32-bit RISC CPU			
<b>Memory</b>	128 MB Flash memory 128 MB SDRAM			
<b>Interface</b>	<ul style="list-style-type: none"> <li>■ RS-232</li> <li>■ USB 2.0</li> <li>■ Internal Ethernet (10/100 Mbps)</li> <li>■ USB host (for scanner or PC keyboard)</li> <li>■ GPIO (dealer option)</li> <li>■ Internal Bluetooth 4.2 MFi (factory option)</li> <li>■ Slot-in 802.11 a/b/g/n wireless (dealer option)</li> </ul>			
<b>Power</b>	Internal universal switching power supply <ul style="list-style-type: none"> <li>■ Input: AC 100-240V, 2.0A, 50-60Hz</li> <li>■ Output: DC 24V, 3.75A, 90W</li> </ul>			

Model	MB240	MB340	MB240T	MB340T
<b>LED/LCD</b>	<ul style="list-style-type: none"> <li>■ 4 intuitive icon indicators</li> <li>■ 1 status indicator</li> </ul>		<ul style="list-style-type: none"> <li>■ 3.5" touch HVGA color LCD</li> <li>■ 1 status indicator</li> </ul>	
<b>Operation switch, button</b>	2 buttons (Pause, Feed)		6 buttons (Menu, Pause/Feed, Up, Down, Left, Right)	
<b>Sensors</b>	<ul style="list-style-type: none"> <li>■ Gap transmissive sensor (position adjustable)</li> <li>■ Black mark reflective sensor (position adjustable)</li> <li>■ Ribbon encoder sensor</li> <li>■ Ribbon end sensor</li> <li>■ Head open sensor</li> </ul>			
<b>Real time clock</b>	Standard			
<b>Built-in fonts</b>	<ul style="list-style-type: none"> <li>■ 8 alpha-numeric bitmap fonts</li> <li>■ Monotype Imaging® true type font engine with one CG Triumvirate Bold Condensed scalable font</li> </ul>			
<b>Barcode</b>	<ul style="list-style-type: none"> <li>■ 1D barcode: Code 39, Code 93, Code128UCC, Code128 subsets A.B.C, Codabar, Interleave 2 of 5, EAN-8, EAN-13, EAN-128, UPC-A, UPC-E, EAN and UPC 2(5) digits add-on, MSI, PLESSEY, POSTNET, RSS-Stacked, GS1 DataBar, Code 11, China Post</li> <li>■ 2D barcode: PDF-417, Maxicode, DataMatrix, QR code, Aztec</li> </ul>			
<b>Font and barcode rotation</b>	0, 90, 180, 270 degree			
<b>Printer language</b>	TSPL-EZD (Compatible to EPL, ZPL, ZPL II, DPL)			
<b>Media type</b>	Continuous, die-cut, black mark, fan-fold, notched (outside wound)			
<b>Media width</b>	20 to 120mm (0.8" to 4.7")			
<b>Media thickness</b>	0.06 to 0.28mm (2.36 to 11 mil)			
<b>Media core diameter</b>	25.4 to 76.2mm (1" to 3")			
<b>Label length</b>	5 to 25,400mm (0.2" to 1000")	5 to 11,430mm (0.2" to 1000")	5 to 25,400mm (0.2" to 1000")	5 to 11,430mm (0.2" to 1000")
<b>Environment condition</b>	Operation: 0 to 40°C, 25 to 85% non-condensing Storage: -40 to 60°C, 10 to 90% non-condensing			

Model	MB240	MB340	MB240T	MB340T
<b>Safety regulation</b>	FCC Class A, CE Class A, RCM Class A, cTUVus, CCC, BIS, TÜV, KC, BSMI, EAC, ENERGY STAR®			
<b>Environmental concern</b>	Comply with RoHS, WEEE			
<b>Accessories</b>	<ul style="list-style-type: none"> <li>■ Quick start guide</li> <li>■ USB cable</li> <li>■ Power cord</li> </ul>			
<b>Limited warranty</b>	<ul style="list-style-type: none"> <li>■ Printer: 2 years</li> <li>■ Printhead: 25km (1 million inches) or 12 months which comes first</li> <li>■ Platen: 50km (2 million inches) or 12 months which comes first</li> </ul>			
<b>Factory options</b>	Internal Bluetooth 4.2 MFi **			
<b>Dealer options</b>	<ul style="list-style-type: none"> <li>■ Peel-off kit</li> <li>■ Regular guillotine cutter (full cut)</li> <li>■ Linerless tear-off kit</li> <li>■ Linerless cutter kit</li> <li>■ GPIO</li> <li>■ 802.11 a/b/g/n wireless module (for device without slot-in housing)*</li> <li>■ 5" OD internal rewinding kit</li> </ul>			
<b>User options</b>	<ul style="list-style-type: none"> <li>■ 802.11 a/b/g/n wireless module (for device with slot-in housing)</li> <li>■ KP-200 Plus keyboard display unit</li> </ul>			

**NOTE:**

\* Either GPIO or wireless interface is available.

\*\* Either wireless or Bluetooth interface is available.



## 2 Operation Overview

### 2.1 Unpacking and Inspection

This printer has been specially packaged to withstand damage during shipping. Please carefully inspect the packaging and printer. Please retain the packaging materials in case you need to reship the printer.

Unpacking the printer, the following items are included in the carton.

- 1 printer unit
- 1 quick installation guide
- 1 power cord
- 1 USB interface cable

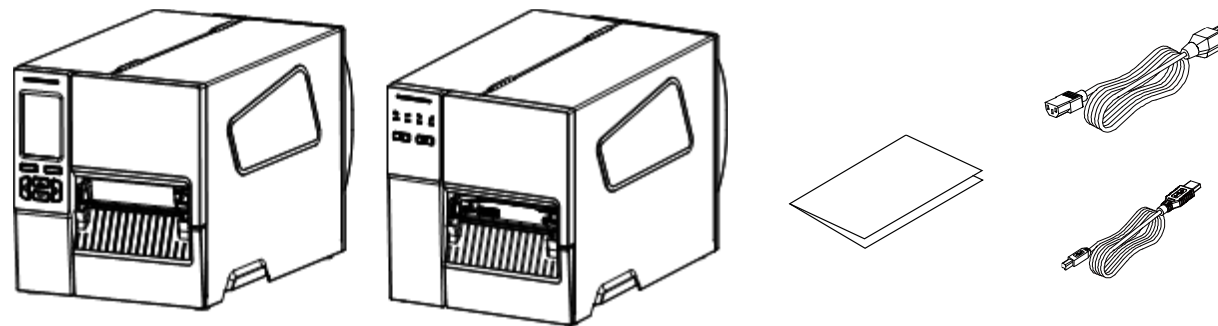

If any parts are missing, please contact the Customer Service Department of your purchased reseller or distributor.

## 2.2 Printer Overview

### 2.2.1 Front View

#### MB240/MB240T Series



1. LED indicator
2. Icons and LED indicators
3. Pause & Feed buttons
4. Media view window
5. Paper exit chute
6. Media cover handle



1. LED indicator
2. LCD touch display
3. Front panel buttons
4. Media view window
5. Paper exit chute
6. Media cover handle

## 2.2.2 Interior View

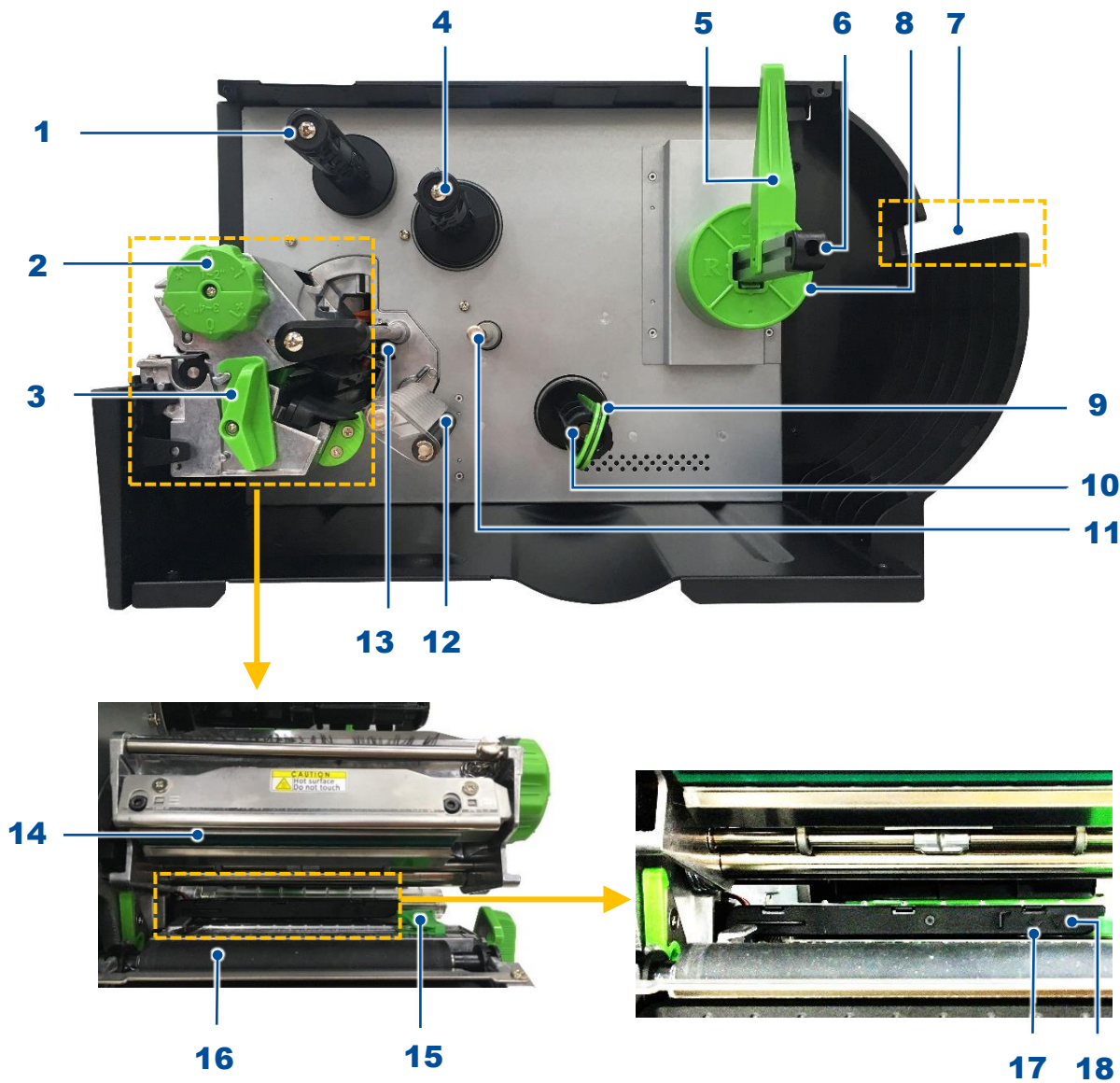

- 1.** Ribbon rewind spindle
- 2.** Print head pressure adjustment knob
- 3.** Print head release lever
- 4.** Ribbon supply spindle
- 5.** Label roll guard
- 6.** Label supply spindle
- 7.** External label entrance chute
- 8.** 3" core adapter
- 9.** Liner securing clip (Optional kit of Peel-off module ass'y)
- 10.** Liner rewind spindle (Optional kit of Peel-off module ass'y)
- 11.** Media guide bar (Optional kit of Peel-off module ass'y)
- 12.** Damper
- 13.** Ribbon end sensor
- 14.** Print head
- 15.** Front label guide
- 16.** Platen roller
- 17.** Black mark sensor (shown as ↓)
- 18.** Gap sensor (shown as ▽)

## 2.2.3 Rear View

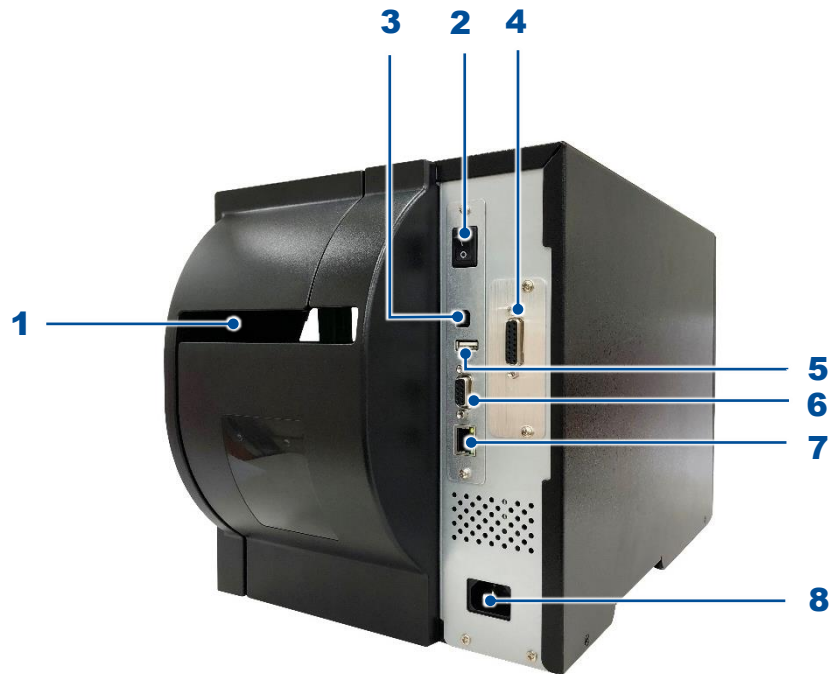

- 1.** External label entrance chute
- 2.** Power switch
- 3.** USB interface (High speed mode)
- 4.** Slot-in Wi-Fi or GPIO interface (Option)
- 5.** USB host
- 6.** RS-232C interface
- 7.** Ethernet interface
- 8.** Power cord socket

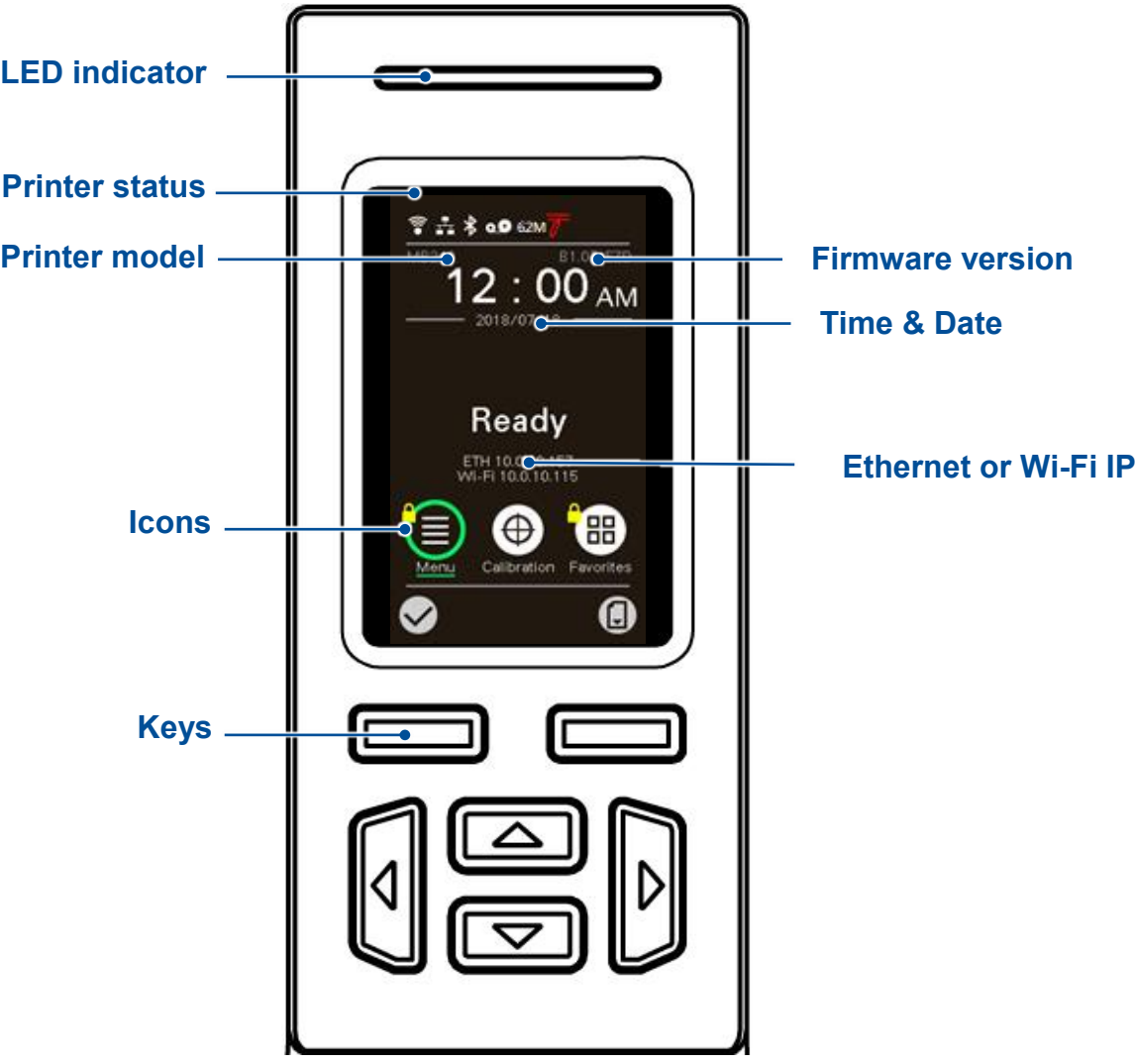
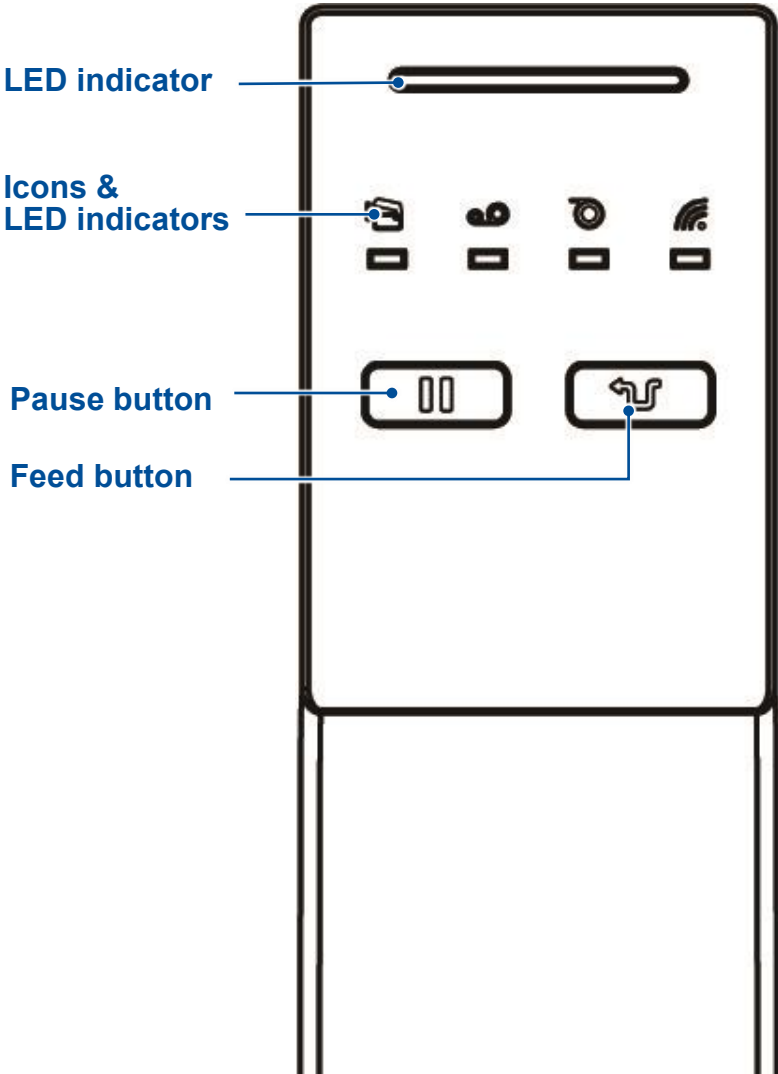

**Note:**  
The interface picture here is for reference only. Please refer to the product specification for the interfaces availability.

# 2.3 Operator Control





### 2.3.1 LED Indication and Keypads





#### LED color indication:

Color	Meaning
 (Green)	<b>Solid:</b> Power is on and ready to be used. <b>Flash :</b> System is downloading data or printer is paused.
 (Amber)	System is clearing data.
 (Red)	<b>Solid</b> - Printer head open, cutter error. <b>Flash</b> - Printing error, such as paper empty, paper jam, ribbon empty, or memory error etc.







#### Keypads:





Keypads form	Item name	Function
	Select keys	Feed, Pause, Confirm, Cancel.
	Navigational keys (MB240T)	Select / Navigate.

## LCD/LED Icon Indication:

icon	Function
	<b>On:</b> Printhead open.
	<b>On:</b> Out of ribbon. <b>Blinking:</b> Ribbon near end.
	<b>On:</b> Out of paper. <b>Blinking:</b> Paper jam.
	<b>On:</b> RF connected. <b>Blinking:</b> RF communication.

## Main Page Icon (MB240T)

Icon	Indication
	Wi-Fi device is ready (option).
	Ethernet is connected.
	Bluetooth device is ready (option).
	Remaining amount of ribbon(m).
	Security lock.
	TPH cleaning.
	Reminds users to clean the printer when printing with the linerless media.

icon	Function
	Enter the menu.
	Calibrate the media sensor.
	Enter the "Favorites" option.
	Enter cursor (be marked in green) located option.
	Feed button (advance one label).

### 2.3.2 Touch Screen Manipulation

Tap an item to open/use it.

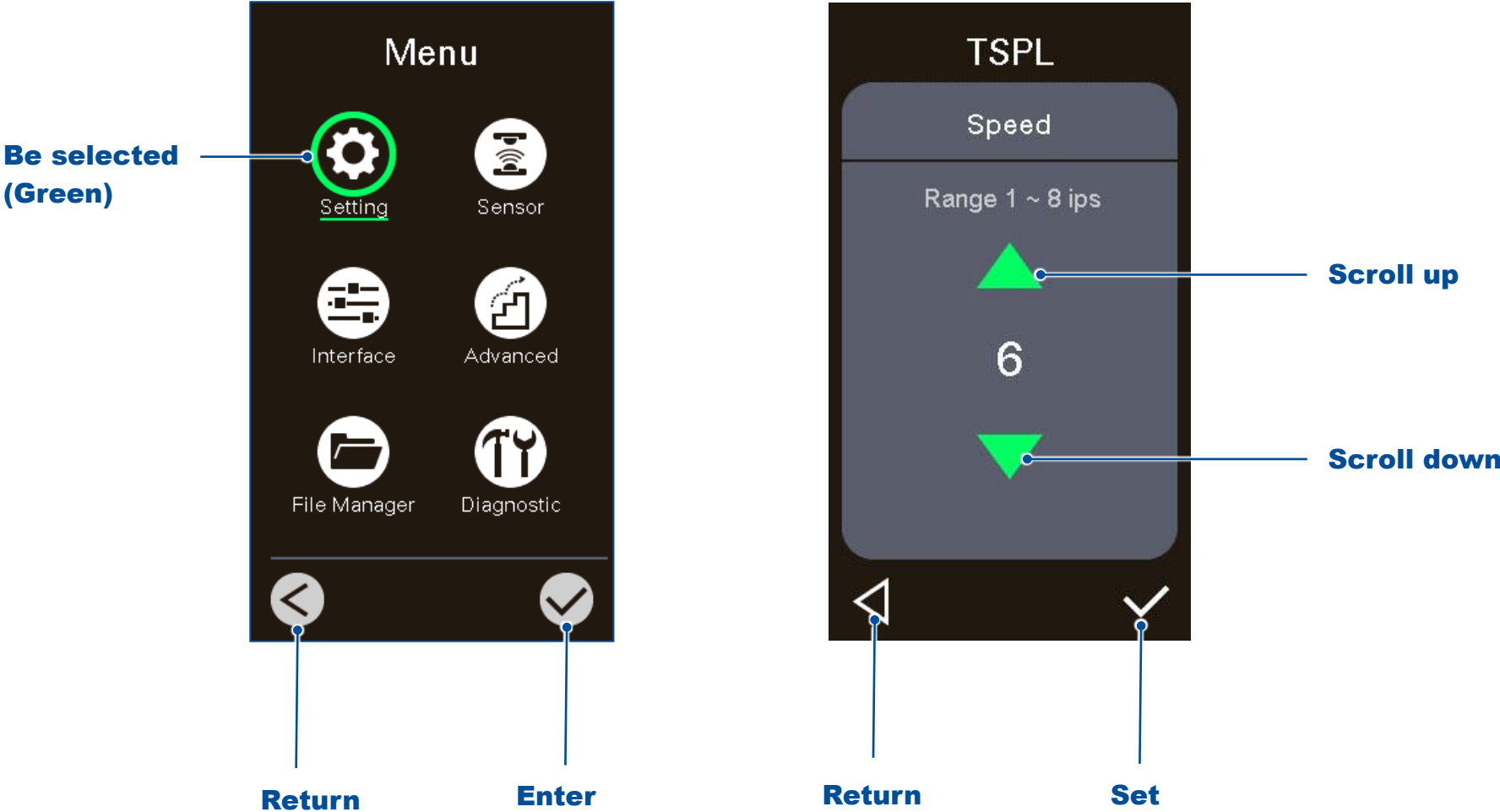





### 2.3.3 Power-on Utilities

**Power-on Utilities** provides the basic functions and can be activated by below procedures:

**Turn off** the power > **Hold** the button > **Open** the power > **Release** the button depending on the color of the LED.

**MB240/ MB340 Series:** Power down and hold the **PAUSE** button  to restart the printer.

**MB240T/ MB340T Series:** Power down and hold the right side of the **Select Keys**   to restart the printer.

#### Sequences of the settings:

LED Colors \ Functions	Amber	Red (5 blinks)	Amber (5 blinks)	Green (5 blinks)	Green / Amber (5 blinks)	Red / Amber (5 blinks)	Solid green
<b>1. Sensor Calibration</b> (Gap / black mark sensor)		Release					
<b>2. Self-Test</b> (And enter dump mode)			Release				
<b>3. Factory Default</b>				Release			
<b>4. Black Mark Calibration</b>					Release		
<b>5. Gap Calibration</b>						Release	
<b>6. READY</b> (Skip AUTO.BAS)							Release

# 3 Setup

## 3.1 Setting up the Printer

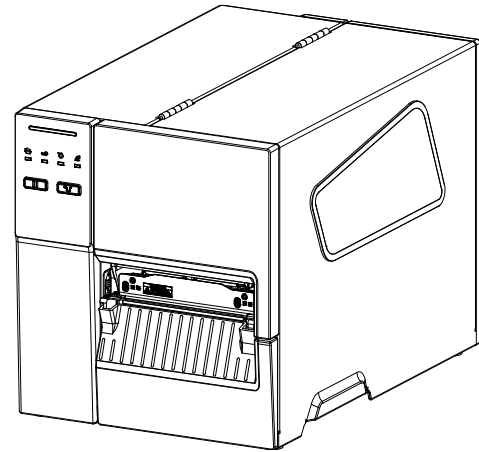
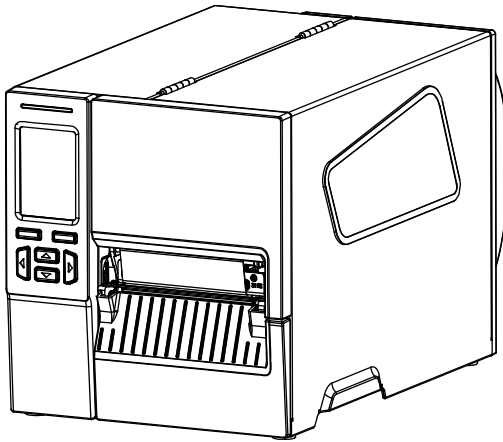

1. Place the printer on flat surface.
2. Make sure the printer is power off.
3. Connect the printer to the computer with the provided USB cable.
4. Plug in the power cord.

◆ **Note: Please switch OFF the printer before plugging in the power cord to printer power jack.**

## 3.2 Loading the Ribbon



1. Open the media cover.



2. Install ribbon on the ribbon supply spindle and paper core on the ribbon rewind spindle.



3. Release the lever.

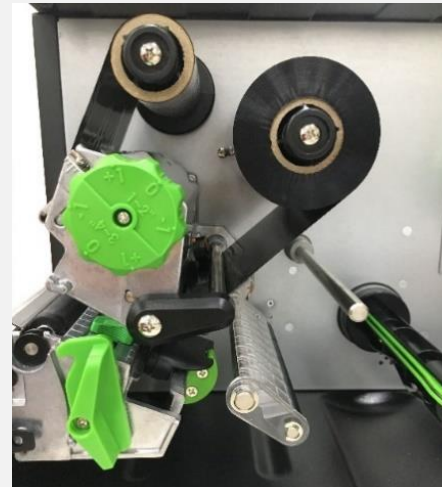

4. Wind the ribbon rewind spindle counterclockwise to tighten the ribbon and remove any slack.



5. Wind the ribbon rewind spindle counterclockwise roughly 3 to 5 circles until the ribbon is smooth, properly stretched and wrinkle-free.



6. Close the printhead mechanism.

### Ribbon Loading Path

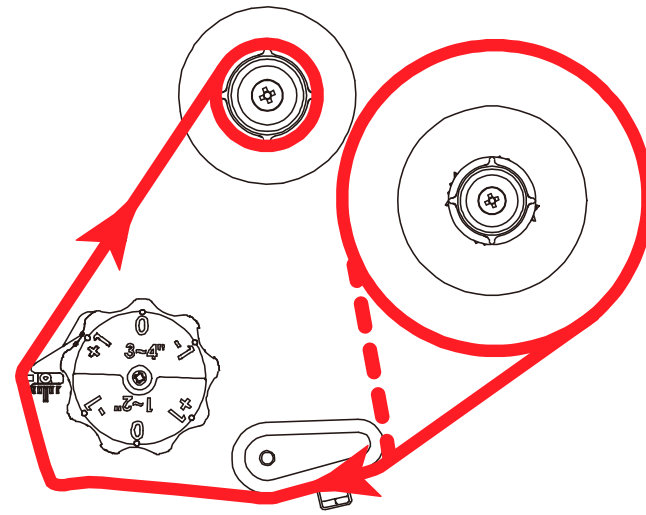

### 3.3 Loading the Media



1. Open the media cover.

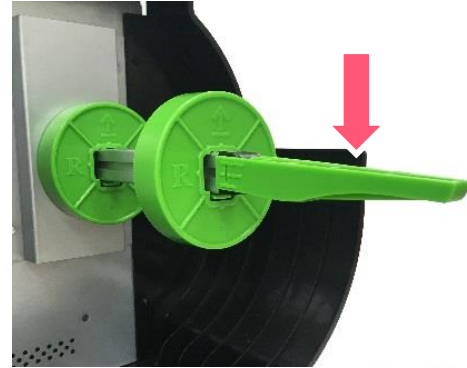

2. Move the label roll guard to the end of the spindle then flip it down.



3. Place the label and use label roll guard to be stabilized



4. Release lever and thread the label through the damper, media sensor, and label guide

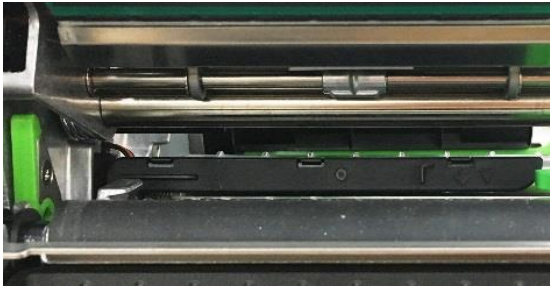

5. Adjust the position of the media sensor.

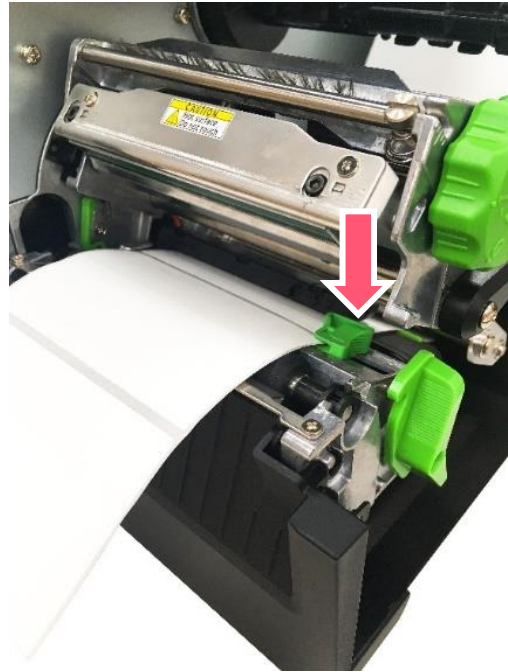

6. Adjust the label guide to fix the media position.



7. Close the Printhead

## 3.4 Loading the Fanfold/External Media



1. Open the printer right side cover.
2. Insert the fanfold media through the rear external label entrance chute.
3. Refer 3.3 to load the media.

### Loading path for fan-fold labels

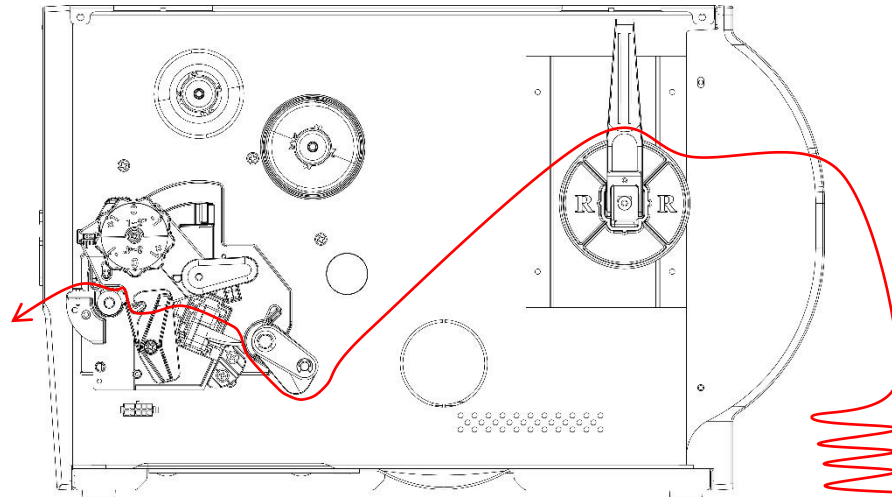

### 3.5 Loading Media in Peel-off Mode (Optional)



1. Open the media cover and load the media.

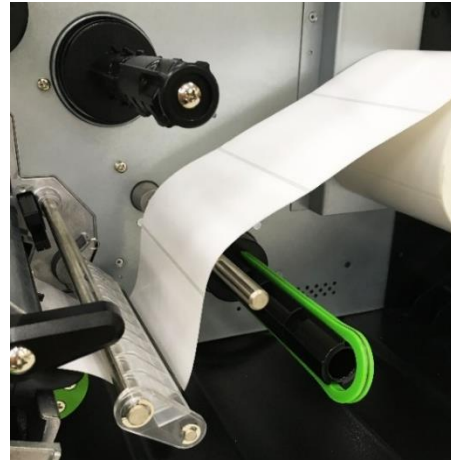

2. Install the label as indicated and set printer mode to Peeler Mode.

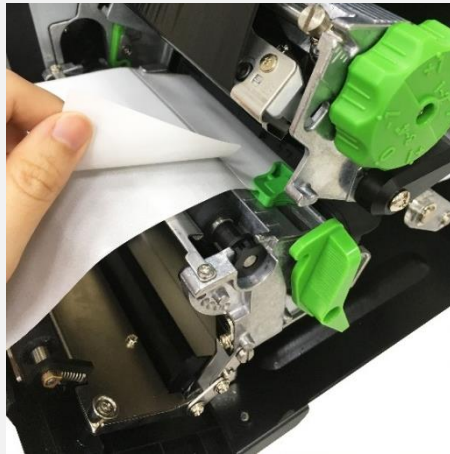

3. Release lever, pull the label off about 650mm and remove the label. Remove several labels to leave liner.

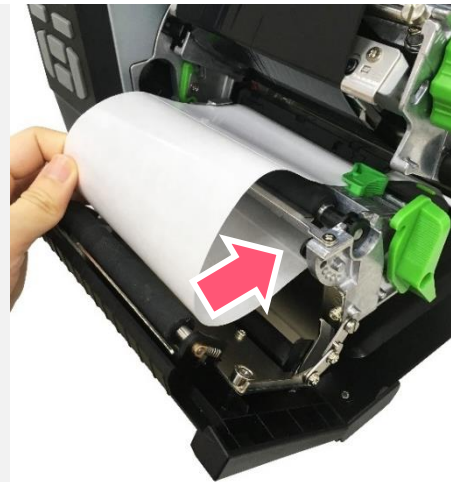

4. Feed the leading edge of liner through the peel-off module slot as indicated.





5. Pull out the media rewind spindle securing clip. Wind the media on the spindle until the liner stretched properly.



6. The media rewind spindle can also install paper core to wind the media.



7. Close the printhead and press FEED Button

### 3.6 Loading Media in Cutter Mode (Optional)



1. Open the media cover, and use the control panel to select to **Cutter Mode**.



2. Install the media and make it unfer go through the cutter paper entrance.



3. Close the printhead and the cutter kit, then press FEED.

## 3.7 Loading the Linerless Media (Optional)

Follow the steps below to load the linerless media for the printer:

**NOTE:** The images below show a printer shipped with a cutter module. The same steps also apply to a printer shipped with a tear-off module.

1. Open the media cover. For how to open the media cover, please refer to [3.3 Loading the Media](#).
2. Load the linerless media onto the media hanger. For how to load the linerless media onto the media hanger, please refer to [3.3 Loading the Media](#).
3. Rotate the printhead release lever to open the printhead.
4. Push the cutter release latch in the indicated direction to open the cutter.

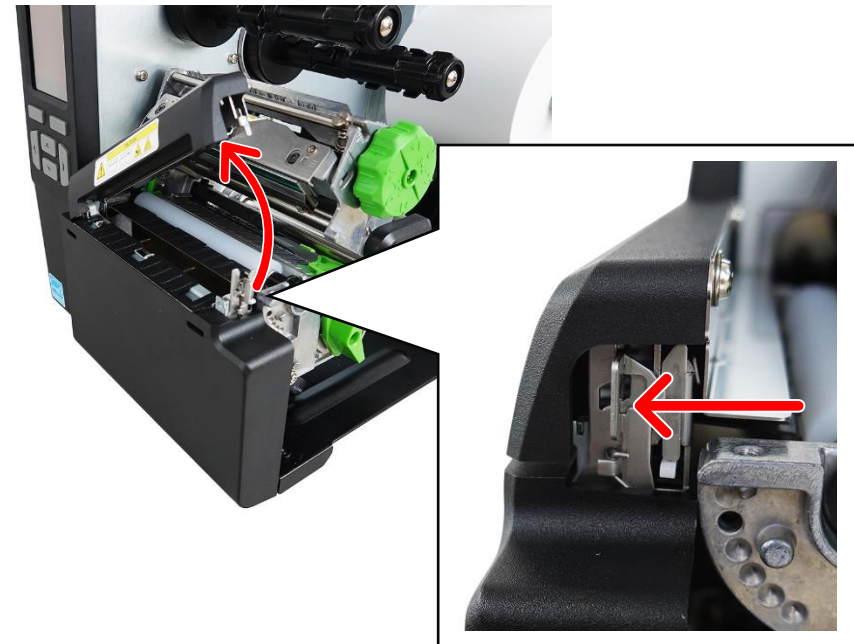
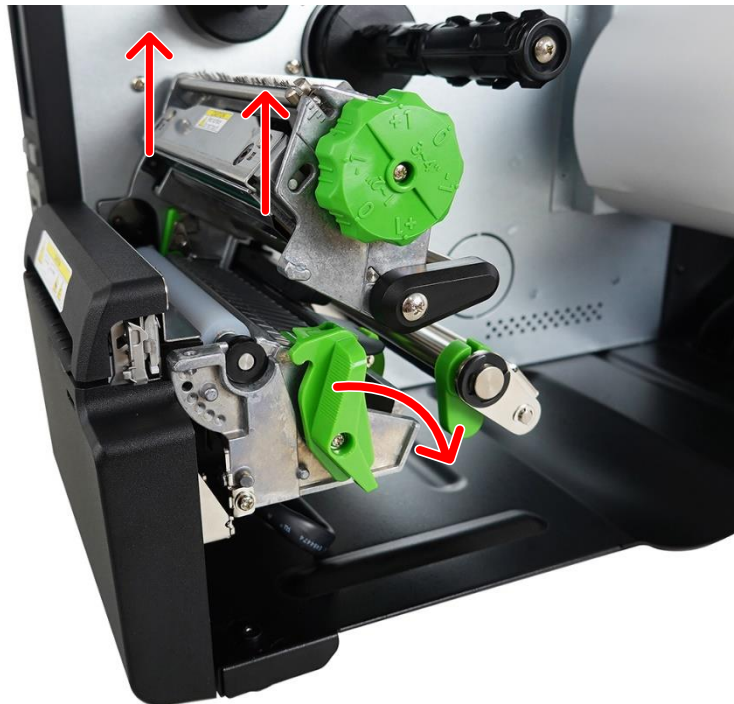

5. Thread the media under the damper assembly, through the media sensor and under the printhead. Keep feeding the media until the media extends out of the front side of the cutter.

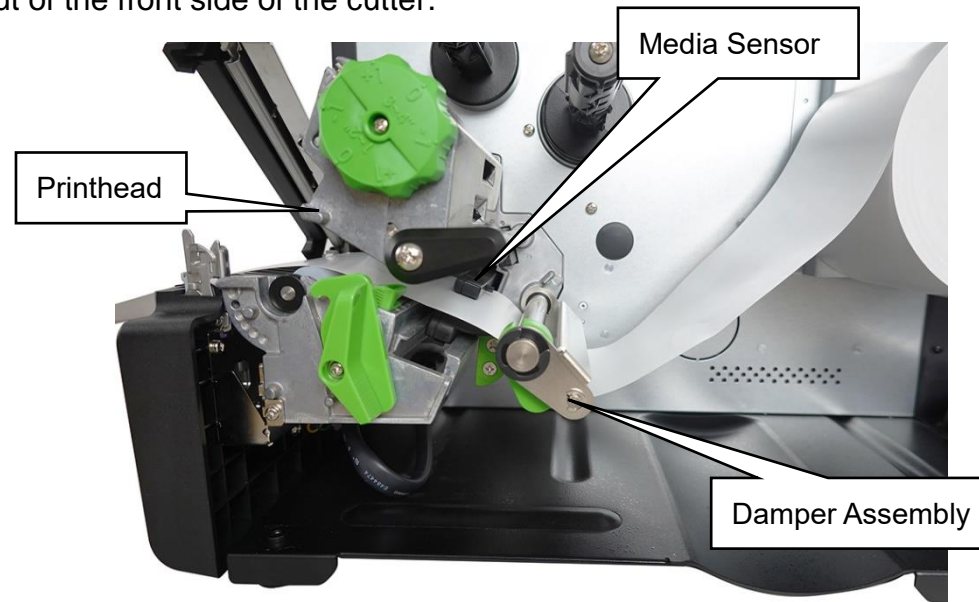

6. Align the media with the media guide ensuring that the media is threaded under the guide.

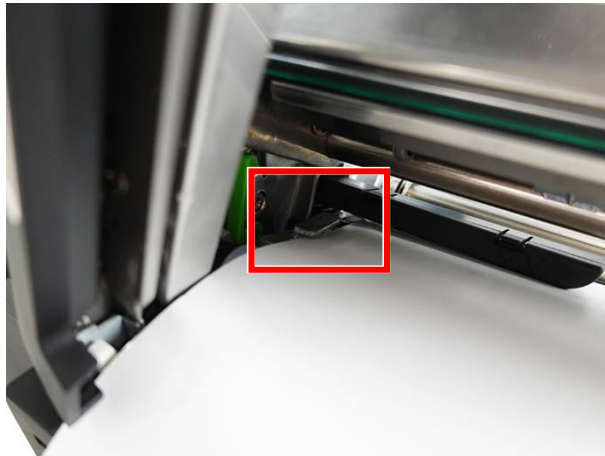

7. Adjust the media guide ensuring that the location of the guide fits with the media's width.

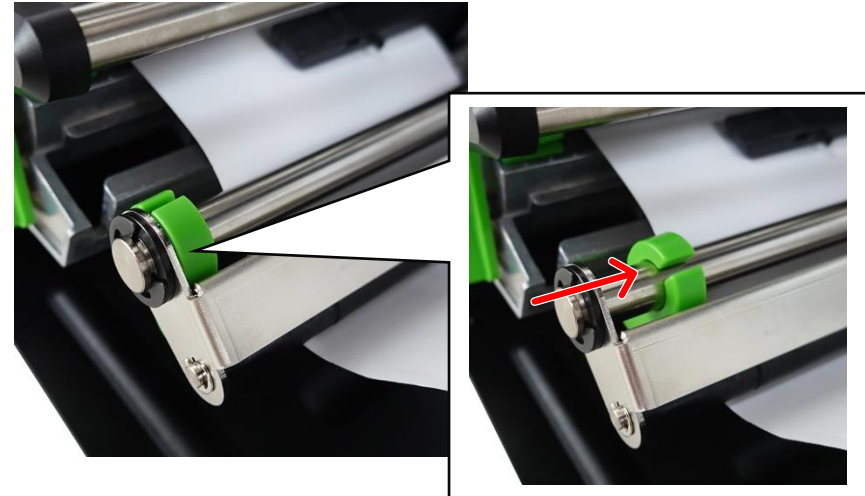

8. Close the cutter until it clicks in place.

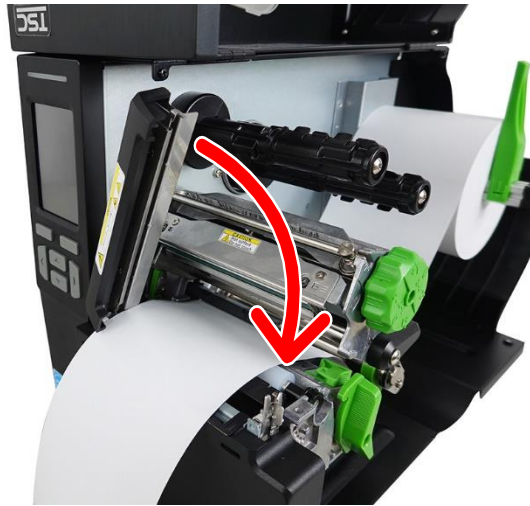

9. Close the printhead ensuring that the printhead is correctly locked by the printhead release lever.

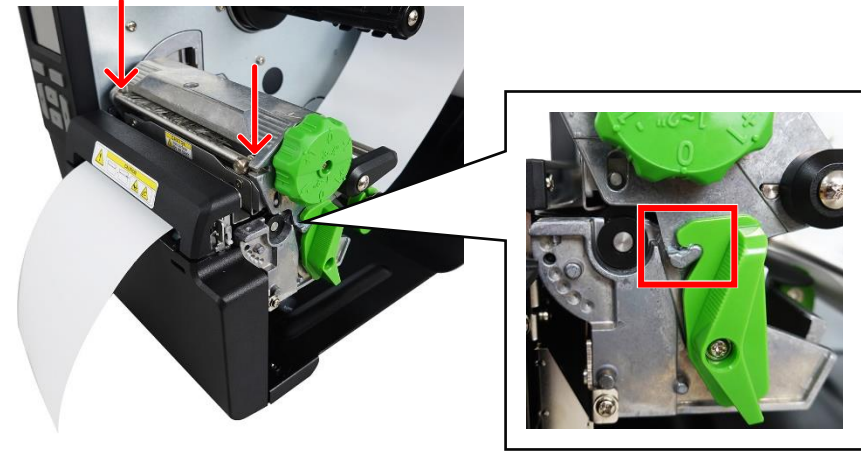

10. (For cutter module only) Insert the ribs on the label tray into its corresponding opening on the front panel of the cutter module.

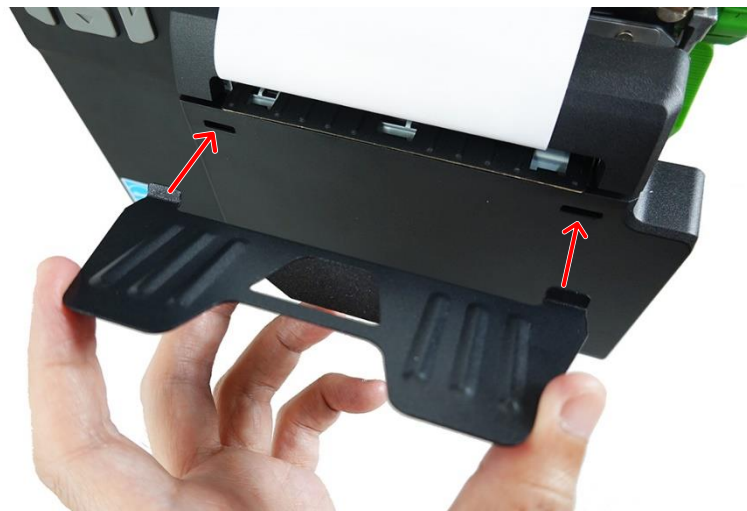

11. Close the media cover.

12. For how to configure the printer, please refer to [6.10 Configuring the Printer and Setting Options for the Linerless Media](#) section to setting the linerless printer.

The images below demonstrate the two printers shipped with cutter module and tear-off module respectively.

**Cutter Module**



**Tear-off Module**



## 4 Knob Adjustment

**Printhead Pressure Adjustment Knob** has 6 levels' adjustment for 1" to 2" and 3" to 4" width media.

Different number means different pressure to the media . Due to printer's paper alignment is on left side of the mechanism, different media width requires the different pressure. Users can try which level can meet their expectation.

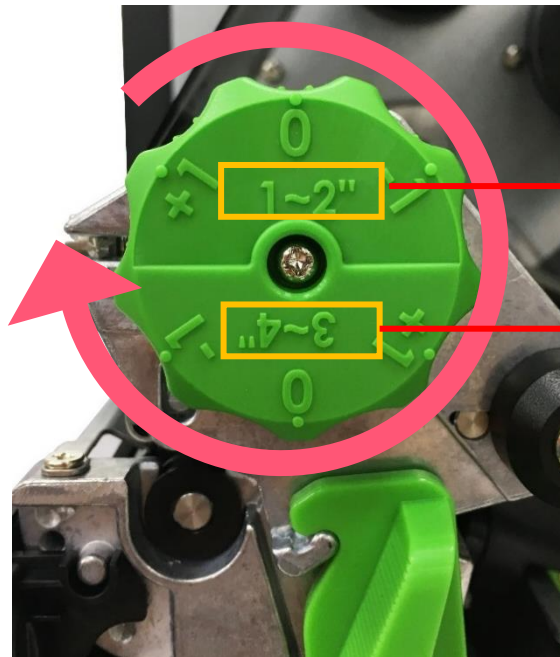

Print Head Pressure Adjustment range from 1~2" media width

Printhead Pressure Adjustment range from 3" to 4" media width

- **0** means regular media thickness (0.14-0.16mm) pressure setting.
- **-1** means lower pressure for thin paper media
- **+1** means higher pressure for thick media

## 4.1 Ribbon Tension Adjustment Knob

**Ribbon Tension Adjustment Knob** has 5 positions for adjustment. Due to the ribbon is aligned to the inbound of print mechanism, different width of ribbon may need to adjust the tension adjustment knob to avoid the ribbon wrinkle and get the best print quality.





## 4.2 Mechanism Fine Adjustment to Avoid Ribbon Wrinkles

**Ribbon wrinkle** is related to the media width, thickness, printhead pressure balance, ribbon film characteristics, print darkness setting...etc. In case the ribbon wrinkle happens, please follow the instructions below to adjust the printer parts.

Ribbon Tension Adjustment Knob has 5 indexes for adjustment. Use flat screw driver to change the ribbon tension.

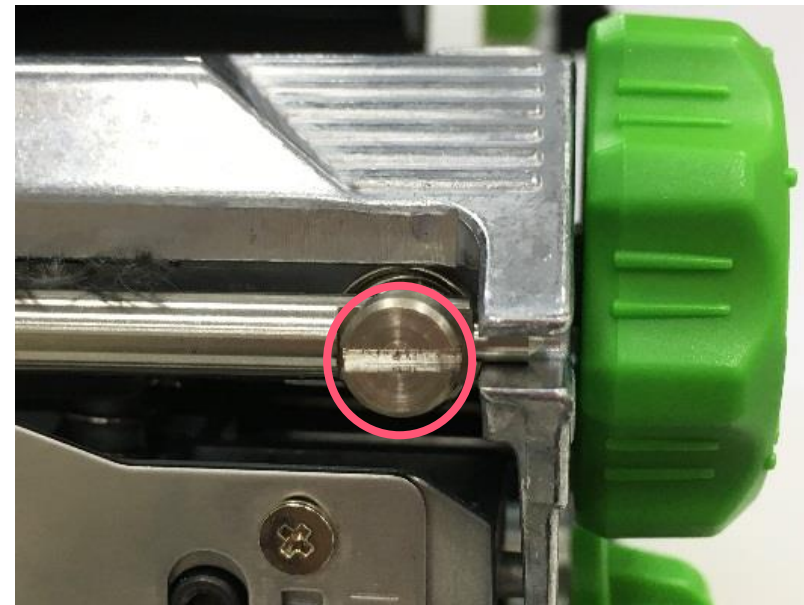

## Wrinkle happens from label lower right to upper left direction

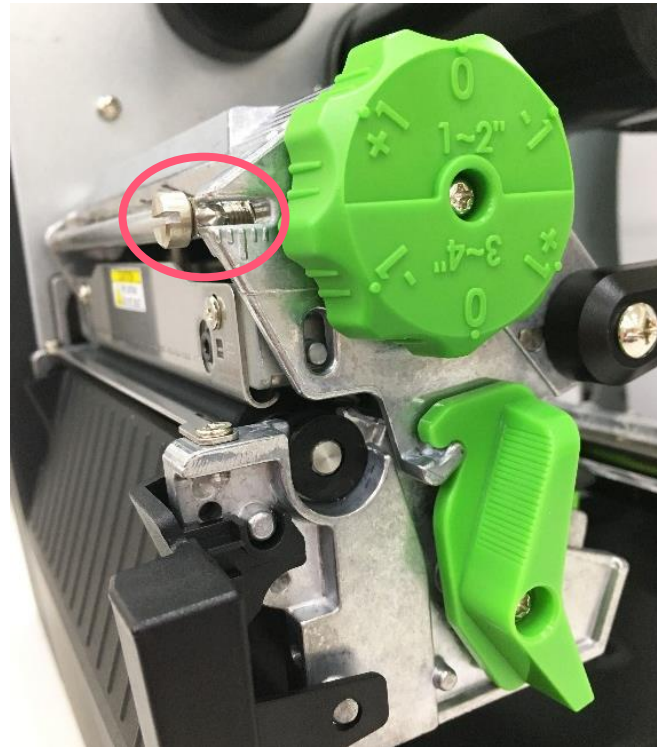
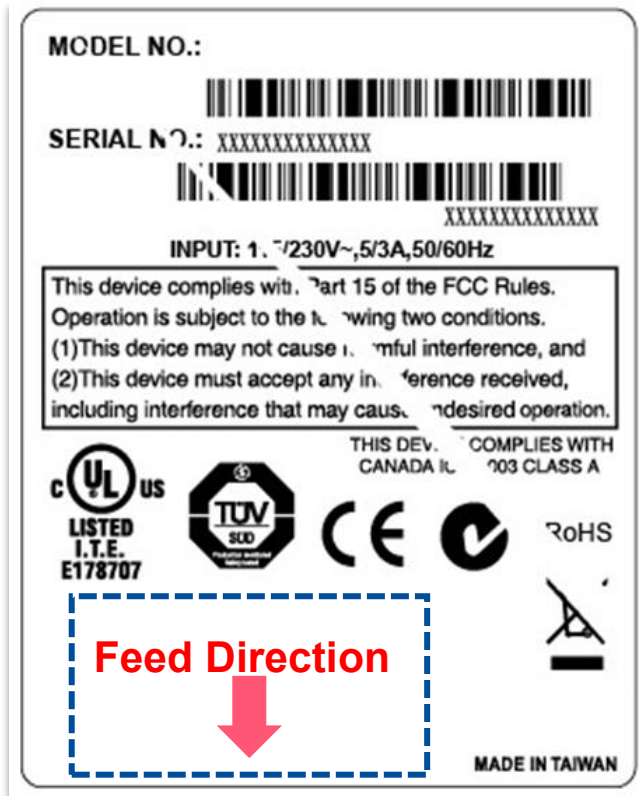

- Make sure the Printhead Pressure Adjustment Knob is in correct position for the current media. Ex: 1 to 2", 3 to 4"
- Turn the screw clockwise per level and print to see if the wrinkle has gone.
- If the ribbon tension adjustment knob has positioned on the level of innermost side but the ribbon slack cannot be removed, please switch the printhead pressure at 1 level and print the label again to check if the wrinkle is gone.
- If the wrinkle can't be avoided, please contact the Customer Service Department of your purchased reseller or distributor for service.

## Wrinkle happens from label lower left to upper right direction

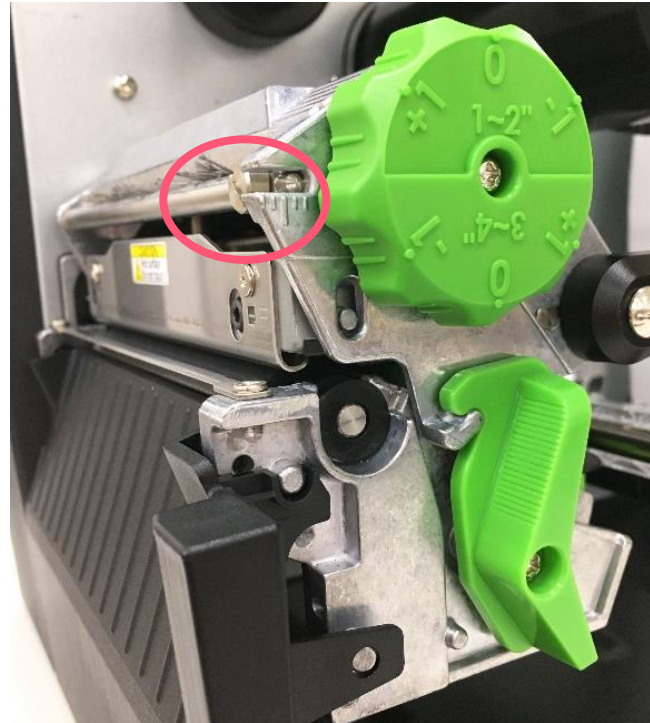
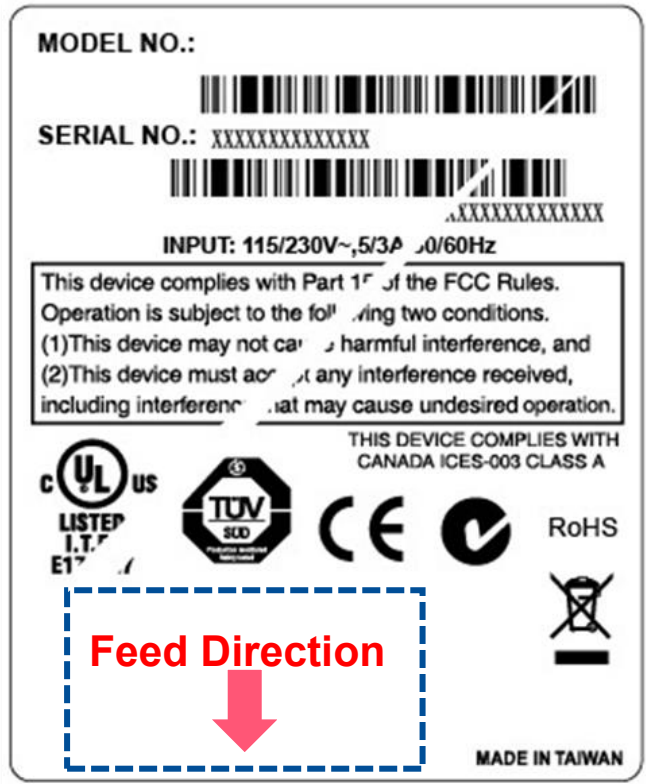

- Make sure the Printhead Pressure Adjustment Knob is in correct position for the current media. Ex: 1" to 2", 3" to 4"
- Turn the screw counterclockwise per level and print to see if the wrinkle has gone.
- If the ribbon tension adjustment knob has positioned on the level of outermost side but the ribbon slack cannot be removed, please switch the printhead pressure at 1 level and print the label again to check if the wrinkle is gone.
- If the wrinkle can't be avoided, please contact the Customer Service Department of your purchased reseller or distributor for service.

# 5 TSC Console

TSC Console is a management tool combining the Printer Management, Diagnostic Tool, CommTool and Printer Webpage settings, which enables you to adjust printer's settings/status; change printers' settings; download graphics, deploy fonts, graphics, label templates or upgrade the firmware to the group of printers, and send additional commands to printers at the same time.

※ **Printer firmware version before A2.12 will only use 9100 Port as command port; Printer firmware after A2.12 will use 6101 Port as command port.**

## 5.1 Start TSC Console

1. Double click TSC Console icon to start the software.

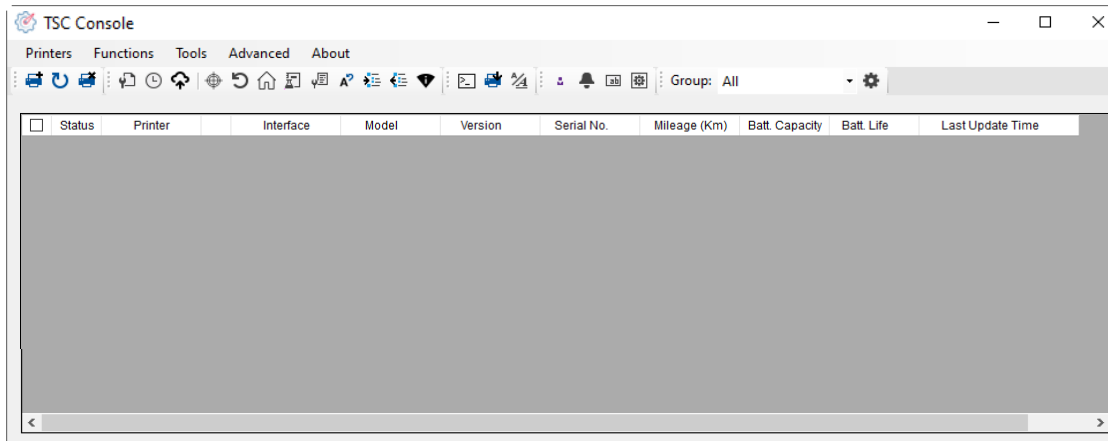

2. Manually add the devices by clicking **Printer > Add Printers**.

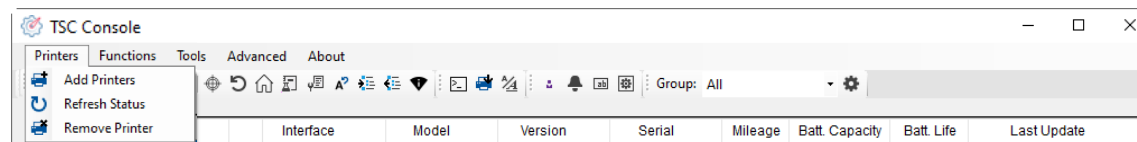

3. Select the current interface of the printer.

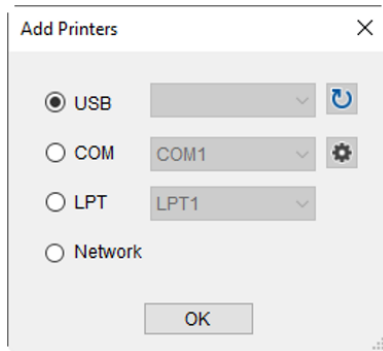

4. The printer will be added to **TSC Console**'s interface.

5. Select the printer and set the settings.

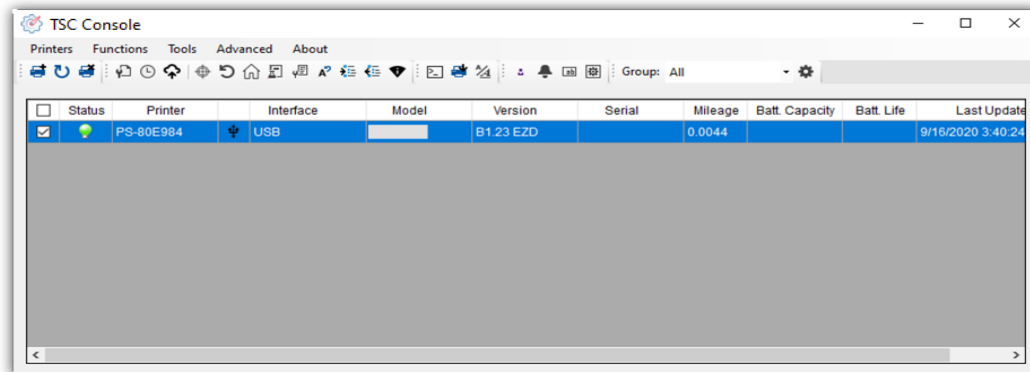

- For more information, please refer to [TSC Console User Manual](#).

# 5.2 Setup Ethernet Interface

- Use **USB** or **COM** to establish the interface on **TSC Console**.

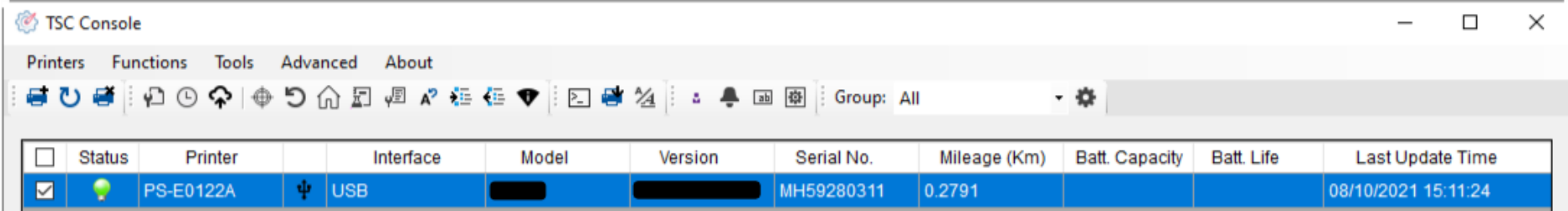

- Double click to enter the **Printer Configuration Page** > Click **Ethernet** tab > Check the **IP Address**.

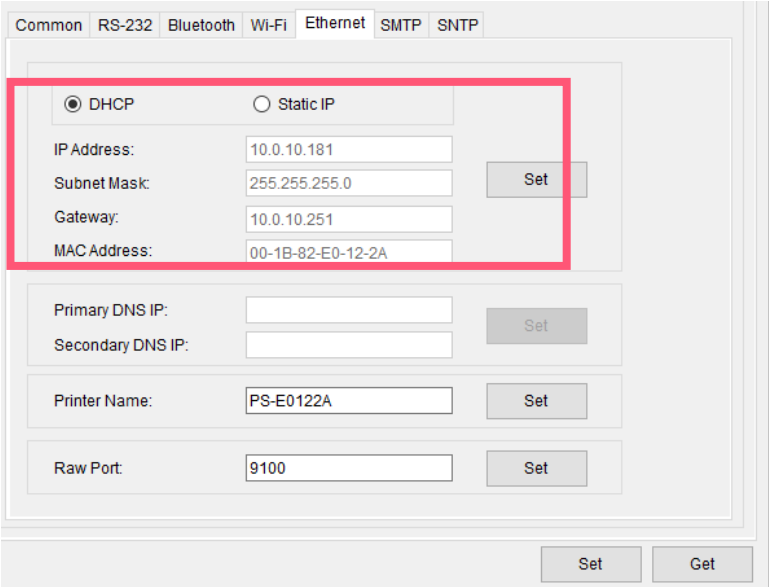
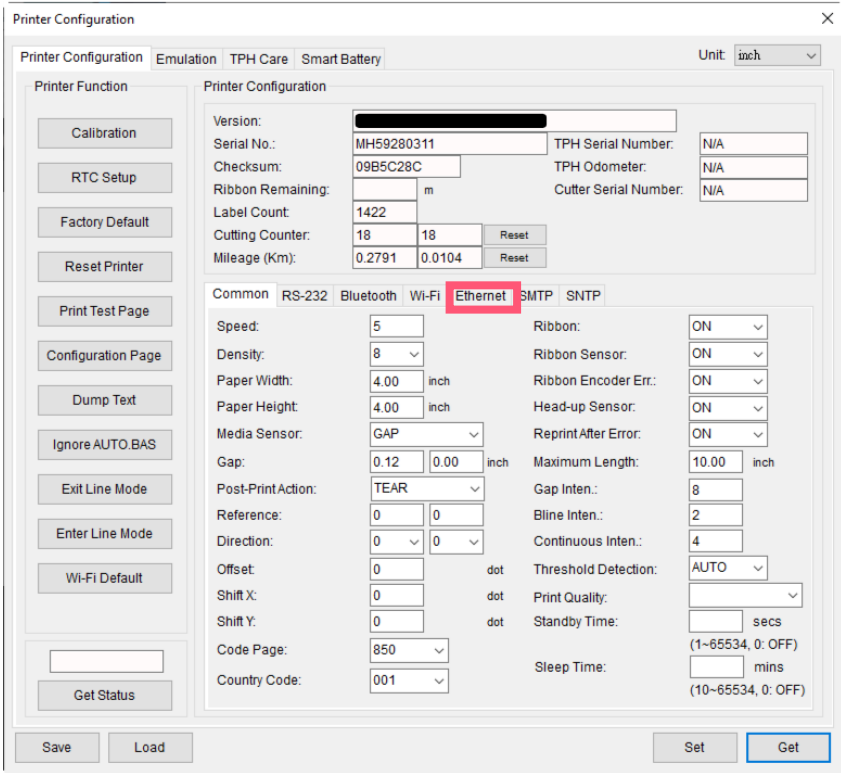

- Return to **TSC Console** main page > Click **Add Printer** on the top left of the window.

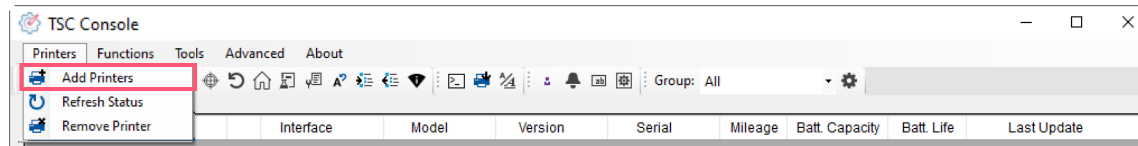

- Choose **Network** > Key in the **IP Address** > Click **Discover** to establish the Ethernet interface.

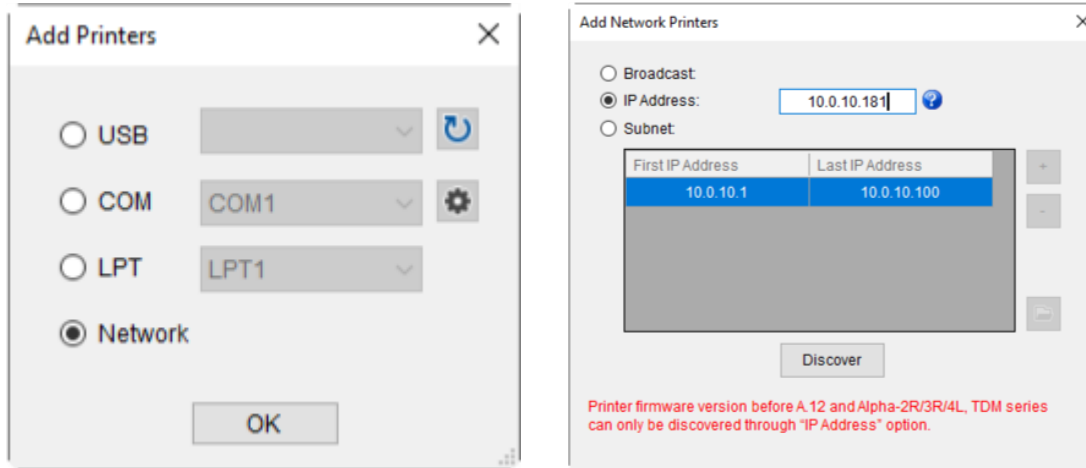

- The notification will pop up > Click **OK** to close the window > The Ethernet interface will be shown on **TSC Console**.

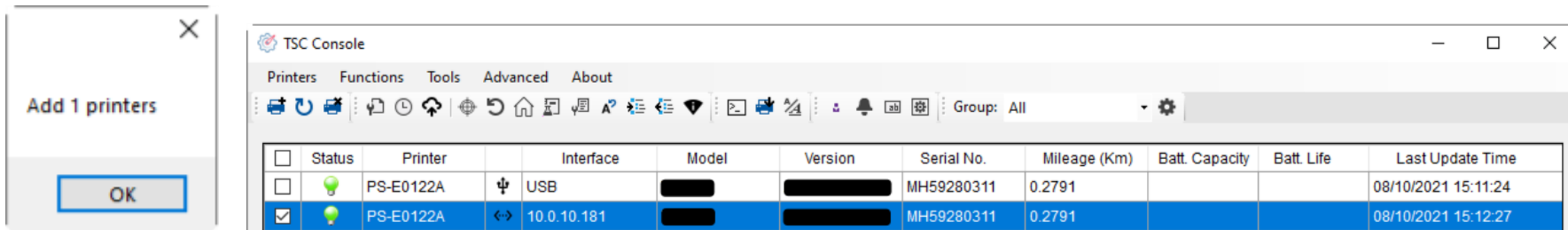

# 5.3 Set Wi-Fi and Add to TSC Console Interface

- Use **USB** or **COM Port** to set up the interface.  
(refer to chp.5.1)
- Double click to enter the printer configuration page.

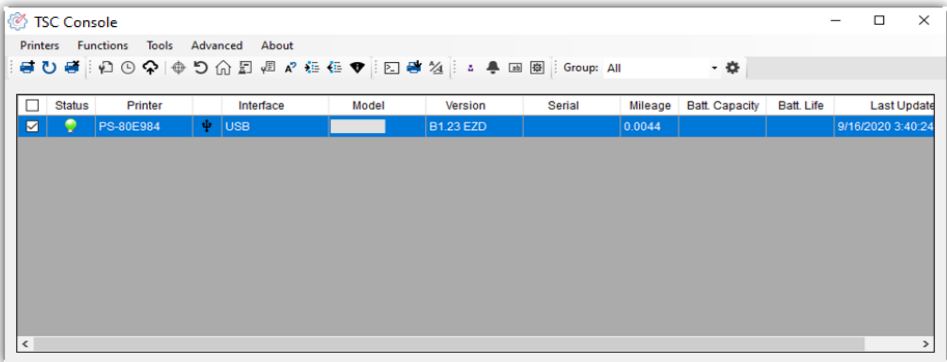

- Click **Get** to receive printer's information.
- Click **Wi-Fi** to the wi-fi setting page.

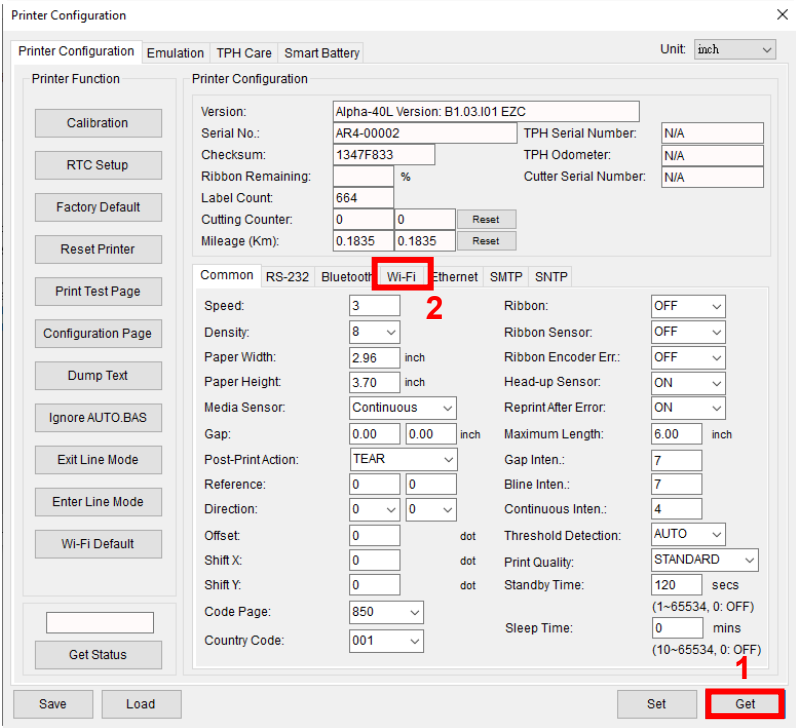



### For WPA-Personal

- I. Fill-in the **SSID**.
- II. Select the Encryption option to **WPA-Personal**.
- III. Fill-in the Key.
- IV. Select **DHCP** to **ON**. (For **OFF** option, please fill-in the IP Address, Subnet Mask and Gateway)
- V. After setting, click the **Set** button.

#### Note:

Before setting, the entered field will be shown in yellow for reminding.  
On DHCP, user can change the printer name by another model name in "Printer Name" field.  
User also can change the raw port in "Raw Port" field.

Common RS-232 Bluetooth Wi-Fi Ethernet SMTP SNTP

Built-in Wi-Fi Module

SSID: SSID\_1

WLAN Encryption: WPA-Personal

Key: ●●●●

DHCP: ON

IP Address: 1

Subnet Mask: 0.0.0.0

Gateway:

Primary DNS IP:

Secondary DNS IP:

Raw Port: 9100

Printer Name: PS-FF153C

MAC Address: 00:1B:82:FF:15:3C

EAP Type:

Username:

Password:

CA Certificate:

Client Certificate:

Private Key:

EAP-FAST PAC:

File Name Browse

Wi-Fi Version: 3.7.1.0R6

RSSI: 0

Set Get

### For WPA-Enterprise

- I. Fill-in the **SSID**.
- II. Select the Encryption option to **WPA-Enterprise**.
- III. Select DHCP to **ON** (For **OFF** option, please fill-in the IP Address, Subnet Mask and Gateway)
- IV. Select the **EAP Type** option. (For **EAP-TLS** option, please upload the CA and Key for mutual authentication, integrity-protected cipher suite negotiation, and key exchange between two endpoints.)
- V. After setting, click the **Set** button.

#### Note:

Before setting, the entered field will be shown in yellow for reminding.  
On DHCP, user can change the printer name by another model name in "Printer Name" field.  
User also can change the raw port in "Raw Port" field.

Common RS-232 Bluetooth Wi-Fi Ethernet SMTP SNTP

Built-in Wi-Fi Module

SSID: SSID\_2

WLAN Encryption: WPA-Enterprise

Key: ●●●●

DHCP: ON

IP Address: 1

Subnet Mask: 0.0.0.0

Gateway:

Primary DNS IP:

Secondary DNS IP:

Raw Port: 9100

Printer Name: PS-FF153C

MAC Address: 00:1B:82:FF:15:3C

EAP Type:

Username:

Password:

CA Certificate:

Client Certificate:

Private Key:

EAP-FAST PAC: 2

File Name Browse

Wi-Fi Version: 3.7.1.0R6

RSSI: 0

Set Get

- After clicking **Set** button, it'll pop-up the window tip as below shown.

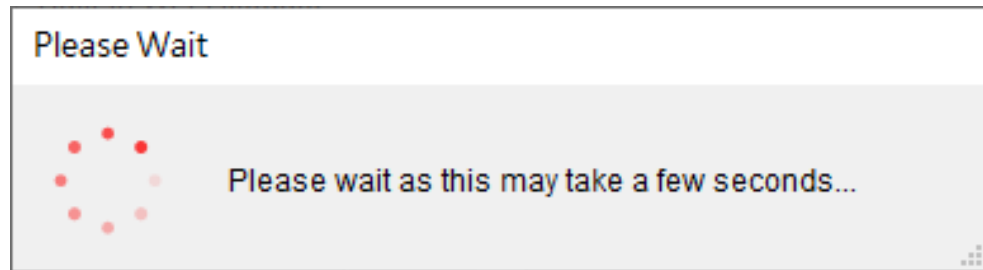

- IP address will be shown in the "IP address" field and the Wi-Fi logo and IP address will be displayed on the LCD control panel.

**Note:**

**IP address should be shown within about 5 to 15 seconds after printer turn on. If not, please refer to steps below to initialize the printer Wi-Fi module settings then to setup it again.**

- Remove the cable between the computer and the printer.
- Go to main page, click **Add Printer** to add the printer via **Network**.
- Select the printer and enter the setting page by double clicking the printer.
- Click the **Print Test Page** button to print the test page via Wi-Fi interface.

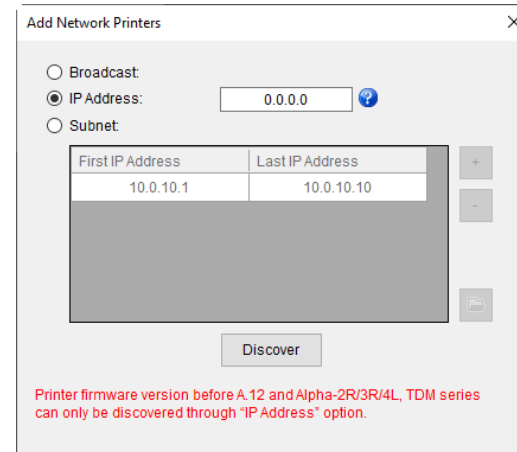

## 5.4 Initialize the Printer WIFI Setting

1. Return to the main page of TSC Console.

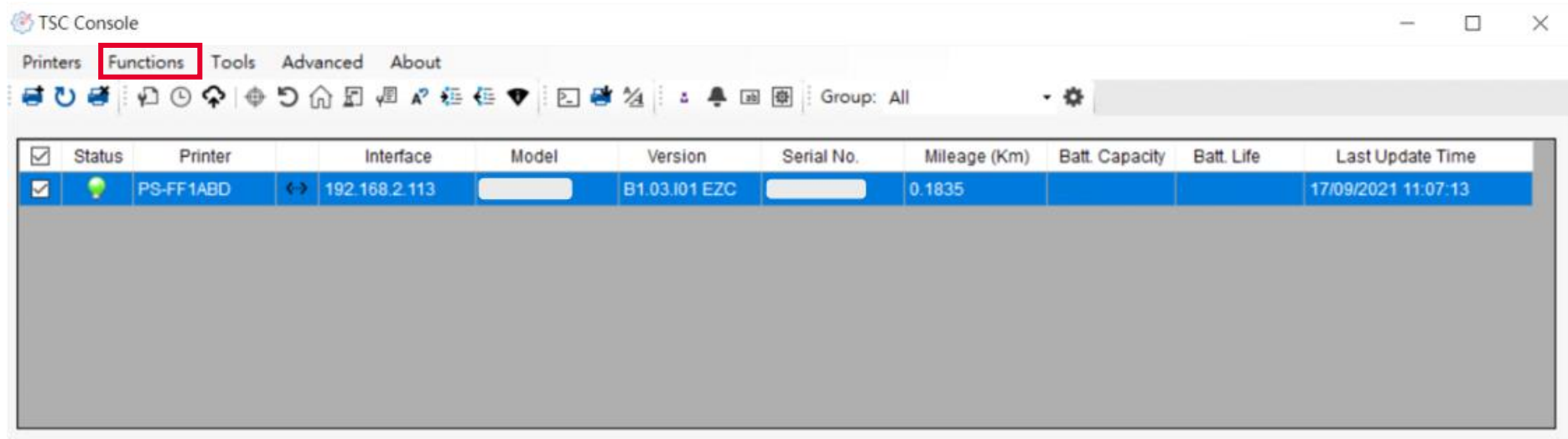

2. Click **Functions** to expand the page.
3. Click **Wi-Fi Default** to initialize the printer Wi-Fi module setting to factory default setting.

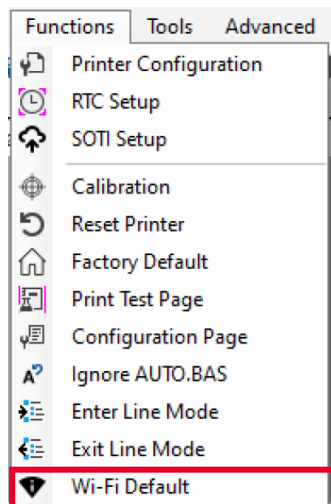

## 5.5 Printer Function

Printer Function could be found in Printer Configuration. “Printer Function” will be shown on the left side of the window.

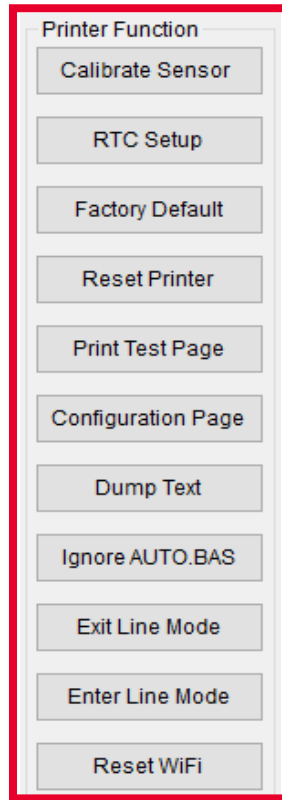

Functions	Description
<b>Calibrate Sensor</b>	Detect media types and the size of the label
<b>RTC Setup</b>	Synchronize printer with Real Time Clock on PC
<b>Factory Default</b>	Initialize the printer to default settings
<b>Reset Printer</b>	Reboot printer
<b>Print Test Page</b>	Print test page according to the specified label size and sensor type.
<b>Configuration Page</b>	Print printer configurations
<b>Dump Text</b>	Activate the printer to dump mode
<b>Ignore AUTO.BAS</b>	Ignore AUTO.BAS file when printer boot up.
<b>Exit Line Mode</b>	Exit the line mode to page mode
<b>Enter Line Mode</b>	Leave page mode and enter line mode
<b>Reset WiFi</b>	Restore the Wi-Fi settings to defaults.

## 5.6 Setting Post-Print Action

When the printer is equipped with other option kits, ex: cutter, peeler, rewinder, please select the mode after finishing the calibration. Follow below procedure to set the post action for the printing:

Refer to section 5.1. **Connect the printer with TSC Console > Double click the printer > The Printer Configuration Page will pop up > Click Get to load information > Go to Common Tab > Find Post-Print Action > Select the mode depends on users' application > Click Set.**

Printer Configuration

Printer Configuration Emulation TPH Care Smart Battery Unit: mm

Printer Function

- Calibration
- RTC Setup
- Factory Default
- Reset Printer
- Print Test Page
- Configuration Page
- Dump Text
- Ignore AUTO.BAS
- Exit Line Mode
- Enter Line Mode
- Wi-Fi Default
- Get Status

Printer Configuration

Version: [ ]  
Serial No.: [ ] TPH Serial Number: N/A  
Checksum: 1344B9B1 TPH Odometer: N/A  
Ribbon Remaining: [ ] % Cutter Serial Number: N/A  
Label Count: 553  
Cutting Counter: 0 0 Reset  
Mileage (Km): 0.0913 0.0913 Reset

Common RS-232 Bluetooth Wi-Fi Ethernet SMTP SNTP

Speed: 3 Ribbon: OFF  
Density: 8 Ribbon Sensor: OFF  
Paper Width: 104.00 mm Ribbon Encoder Err.: OFF  
Paper Height: 74.05 mm Head-up Sensor: ON  
Media Sensor: Black Mark Reprint After Error: ON  
Gap: 1.99 0.00 mm Maximum Length: 152.25 mm  
Post-Print Action: [ ] Gap Inten.: 7  
Reference: OFF Bline Inten.: 7  
Direction: TEAR Continuous Inten.: 4  
Offset: PEEL Threshold Detection: AUTO  
Shift X: CUTTER Print Quality: STANDARD  
Shift Y: REWIND Standby Time: 120 secs  
Code Page: 850 Sleep Time: 0 mins  
Country Code: 001 (1~65534, 0: OFF)  
(10~65534, 0: OFF)

Save Load

Set Get

# 6 LCD Menu Function

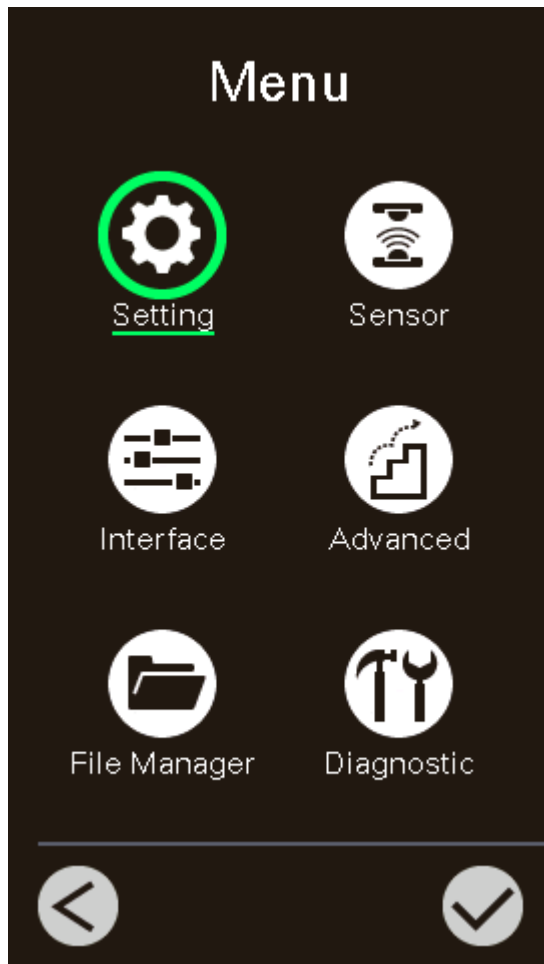

## 6.1 Enter the Menu



- **By touch display:**

Tap the  (Menu) icon on LCD main page to enter the menu.

- **By Keys:**

Use navigational keys to select the  (Menu) icon (be marked in green) and press the left soft key button (means  ) to enter the menu.

## 6.2 Menu Overview

There are 6 categories on the menu. Users can easily set the settings of the printer without connecting the computer. Please refer to following sections for more details.



**Setting** : To set up the printer settings for TSPL & ZPL2.



**Advanced** : To set LCD, initialization, cutter type,...etc.



**Sensor** : To calibrate the selected media sensor.



**File Manager** : To check and manage printer's memory storage.

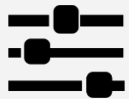

**Interface** : To set the printer interface settings.



**Diagnostic** : To check printer and help users to troubleshoot the problems.

## 6.3 Setting

Tap the **Command Set** on LCD to switch between TSPL and ZPL2. **Command Set** can also be activated by **Navigational Keys**.

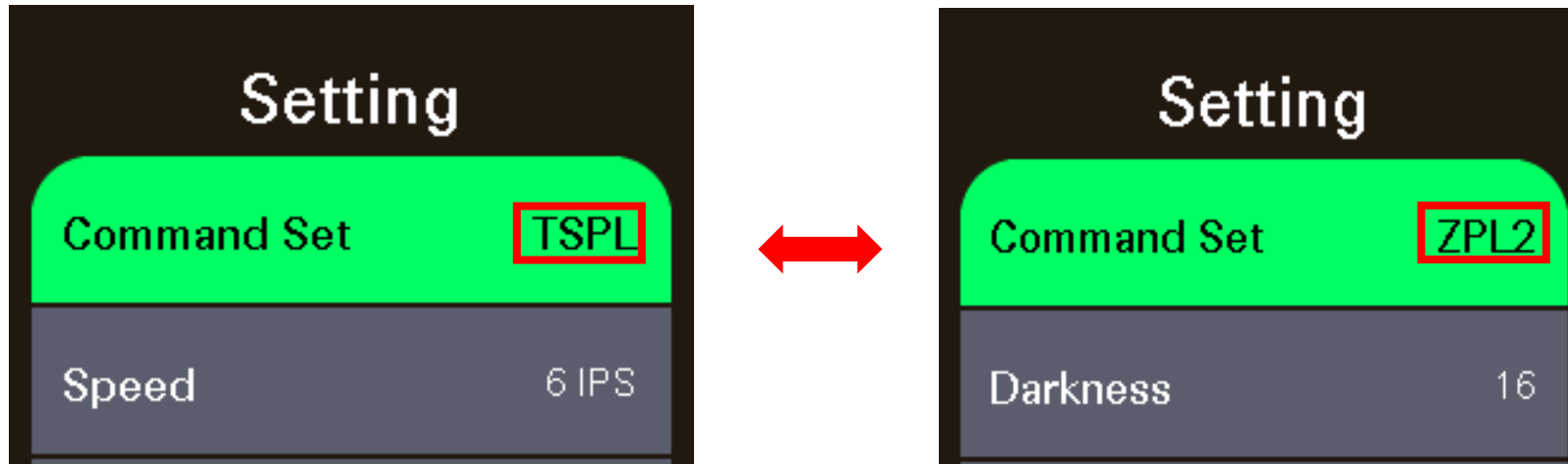



### 6.3.1 TSPL

TSPL category can set up the printer settings for TSPL.

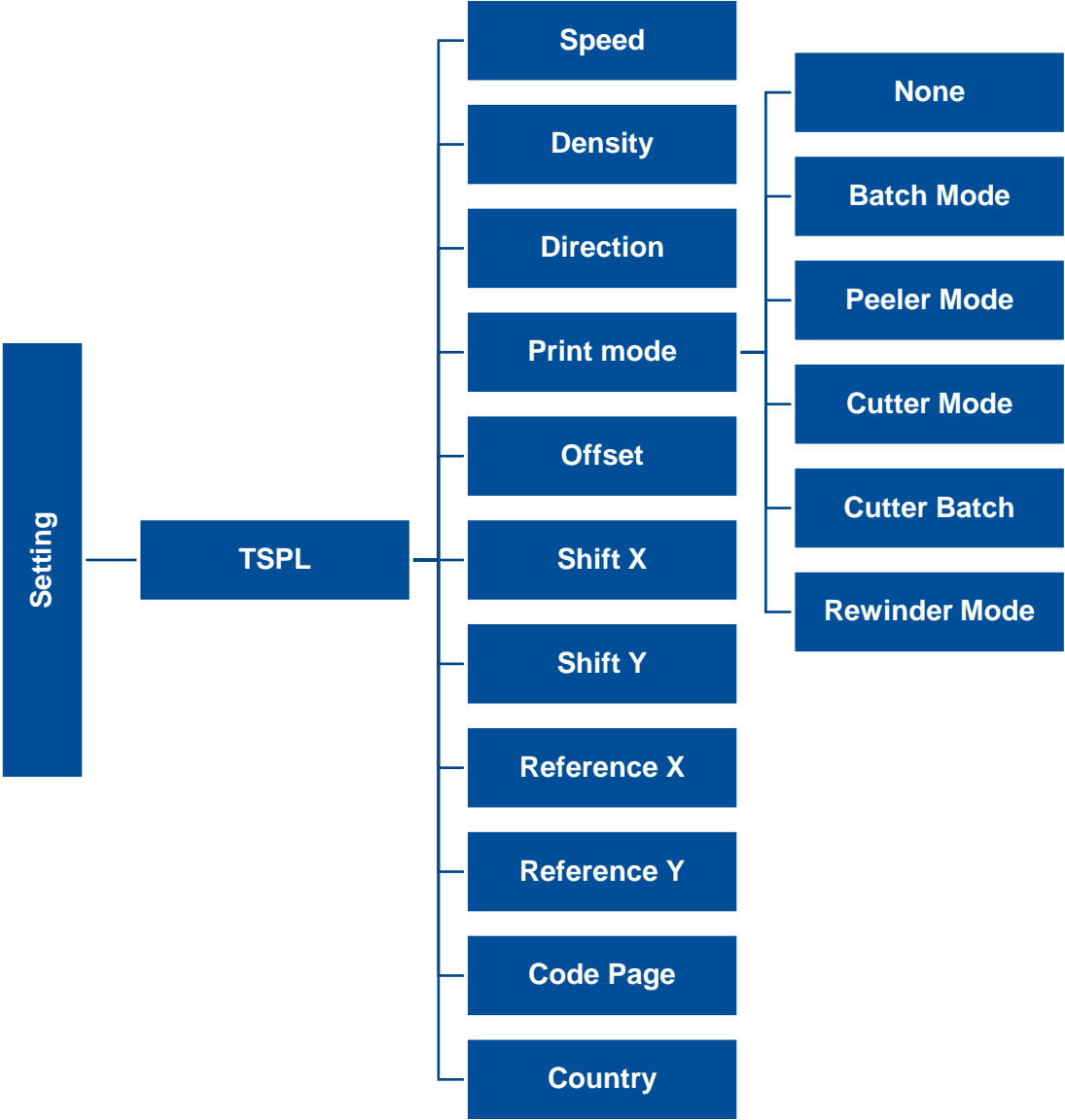

Item	Description	Default
<b>Speed</b>	Set the print speed. Setting range: 1 to 10 for 203dpi; 1 to 7 for 300dpi.	<b>203 dpi: 5</b> <b>300 dpi: 3</b>
<b>Density</b>	Set printing darkness. Setting range: 0 to 15, and the step is 1.	<b>8</b>
<b>Direction</b>	Set the printout direction. Setting Value: 0 and 1. Direction 0: <input type="text" value="Direction"/> Direction 1: <input type="text" value="Direction"/>	<b>0</b>
<b>Print mode</b>	Set the print mode. There are 6 modes in total: <b>None:</b> Next label top of form is aligned to the printhead burn line location. (Tear Off Mode) <b>Batch Mode:</b> Once finishing the printing process, label will be fed to the tear plate location. <b>Peeler Mode:</b> Enable the label peel off mode. <b>Cutter Mode:</b> Enable the label cutter mode. <b>Cutter Batch:</b> Cut the label once at the end of the printing job. <b>Rewinder Mode:</b> Enable the label rewinder mode.	<b>Batch Mode</b>
<b>Offset</b>	Adjust media stop location. Available value setting range: -999 dots to 999 dots.	<b>0 dot</b>
<b>Shift X</b>	Adjust print position. Available value setting range: -999 dots to 999 dots.	<b>0 dot</b>
<b>Shift Y</b>		<b>0 dot</b>
<b>Reference X</b>	Set the origin of printer coordinate system horizontally and vertically. Available setting range: 0 dot to 999 dots.	<b>0 dot</b>
<b>Reference Y</b>		<b>0 dot</b>
<b>Code page</b>	Set the code page of international character set.	<b>850</b>
<b>Country</b>	Set the country code. Available setting value range: 1 to 358.	<b>001</b>

**Note:** If printing from enclosed software/driver, the software/driver will send out the commands, which will overwrite the settings set from the panel.

### 6.3.2 ZPL2

This "ZPL2" category can set up the printer settings for ZPL2.

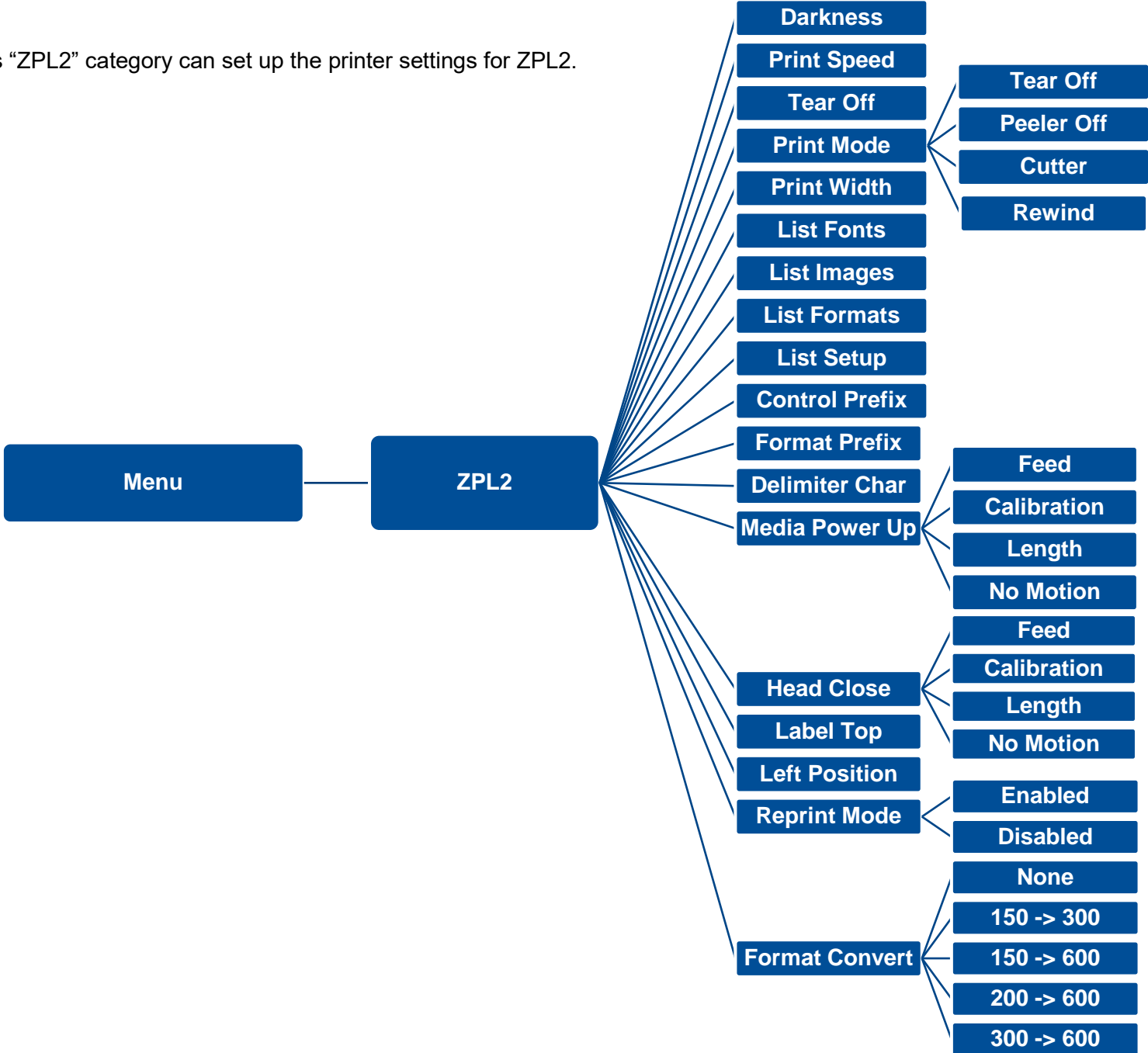

Item	Description	Default
Density	Set the printing darkness. Available setting range: 0 to 30.	16
Print Speed	Set the print speed. Available setting range is 1 to 10 for 203dpi and 1 to 7 for 300dpi.	203 dpi: 4 300 dpi: 3
Tear Off	Adjust media stop location. Available setting value range: -120 to 120 dots.	0 dot
Print mode	<p>Set the print mode. There are 4 modes:</p> <p><b>Tear Off:</b> Next label top of form is aligned to the printhead heating line location.</p> <p><b>Peeler Off:</b> Enable the label peel off mode.</p> <p><b>Cutter:</b> Enable the label cutter mode</p> <p><b>Rewind:</b> Enable the label rewind mode</p>	Tear Off
Print Width	Set the print width. Available setting range: 2 to 999 dots.	812
List Fonts	Print the current fonts list from the memory devices to the label.	N/A
List Images	Print current printer available images list stored at the memory device to the label.	N/A
List Formats	Print current printer available formats list from the memory devices to the label.	N/A
List Setup	Print current printer configuration to the label.	N/A
Control Prefix	Set control prefix character.	N/A
Format Prefix	Set format prefix character.	N/A
Delimiter Char	Set delimiter character.	N/A

Item	Description	Default
<b>Media Power Up</b>	Set the action of the media when turning on the printer. <b>Feed:</b> Printer will advance one label. <b>Calibration:</b> Printer will make calibration. <b>Length:</b> Printer determine length and feed label. <b>No Motion:</b> Printer will not move media.	<b>No Motion</b>
<b>Head Close</b>	Set the action of the media when closing the printhead. <b>Feed:</b> Printer will advance one label. <b>Calibration:</b> Printer will make calibration. <b>Length:</b> Printer determine length and feed label. <b>No Motion:</b> Printer will not move media.	<b>No Motion</b>
<b>Label Top</b>	Adjust print position vertically on the label. Value range: -120 to +120 dots.	<b>0</b>
<b>Left Position</b>	Adjust print position horizontally on the label. Value range:-9999 to +9999 dots.	<b>0</b>
<b>Reprint Mode</b>	Reprint the last label by pressing  button on printer's control panel.	<b>Disabled</b>
<b>Format Convert</b>	Select the bitmap scaling factor. The first number is the original dots per inch (dpi) value; the second the dpi which you would like to scale.	<b>None</b>

## 6.4 Sensor

This option is used to calibrate the selected sensor. We recommend calibrate the sensor before printing when changing the media.

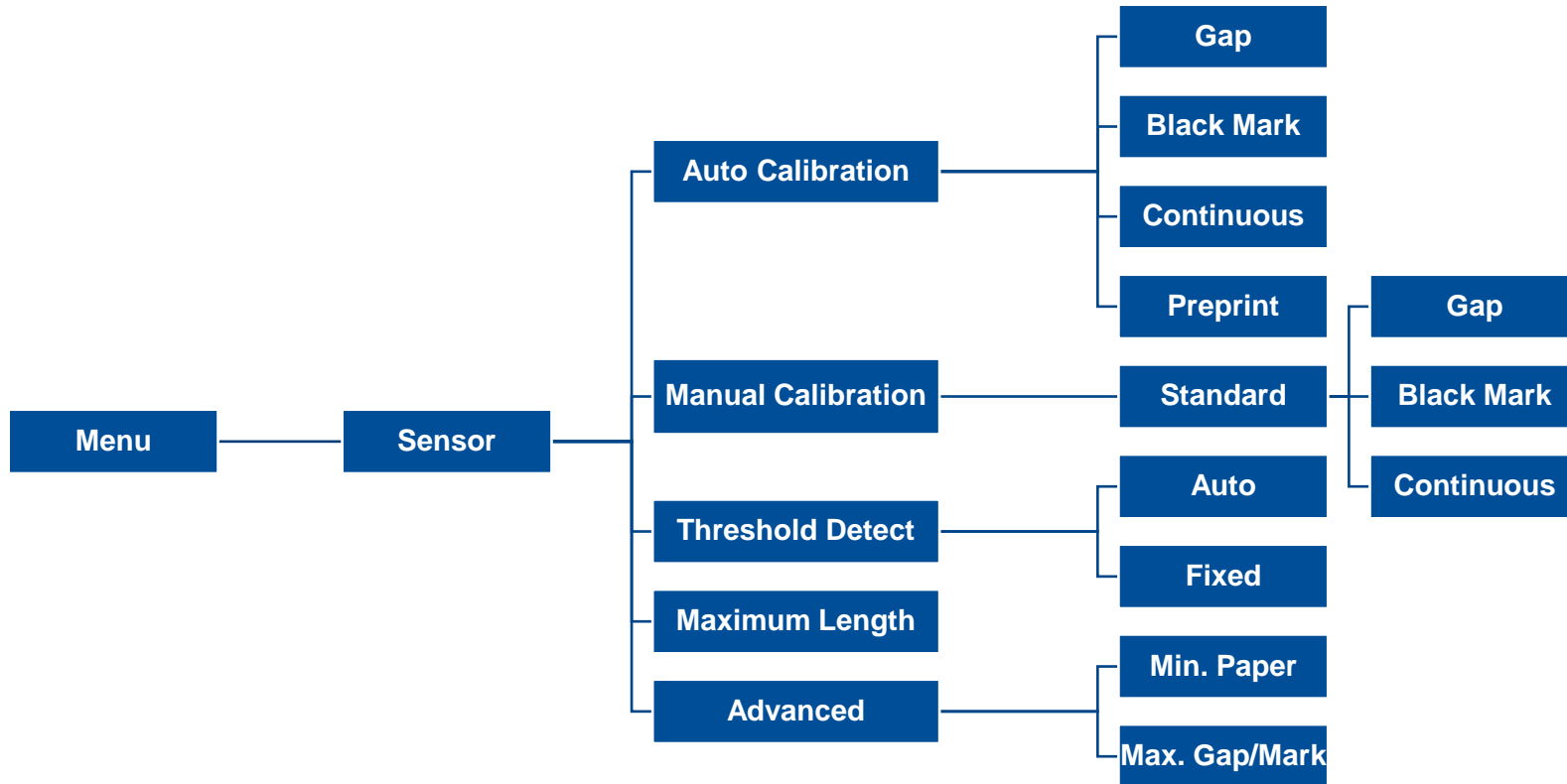

Item	Description	Default
<b>Auto Calibration</b>	Set the media sensor type and calibrate the selected sensor automatically.	N/A
<b>Manual Calibration</b>	In case Auto Calibration does not work, please use “Manual” function to set the paper length and gap/black mark size to complete the calibration setting.	N/A
<b>Threshold Detect</b>	Set sensor sensitivity in fixed or auto.	Auto
<b>Maximum Length</b>	Set the maximum length for label calibration.	254 mm
<b>Advanced</b>	Set the minimum paper length and maximum gap/black mark length for auto-calibration.	0 mm

## 6.5 Interface

**Interface** can set the printer interface settings.

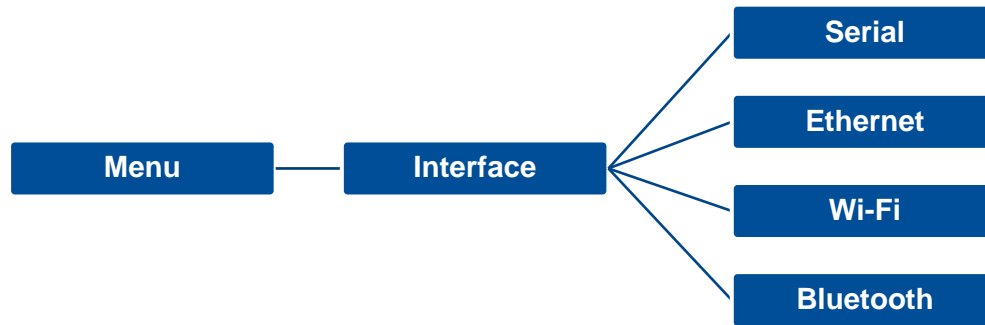

### 6.5.1 Serial COM

Serial comm can set the printer RS-232 settings.

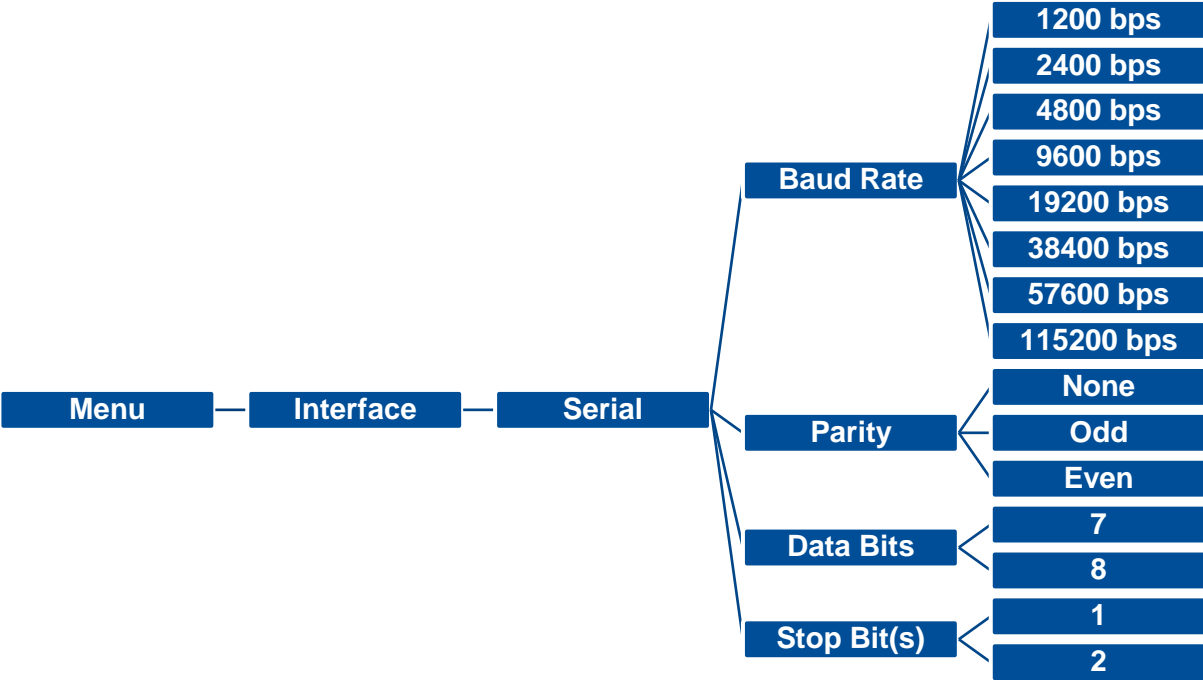

Item	Description	Default
<b>Baud Rate</b>	Set the RS-232 baud rate.	<b>9600</b>
<b>Parity</b>	Set the RS-232 parity.	<b>None</b>
<b>Data Bits</b>	Set the RS-232 Data Bits.	<b>8</b>
<b>Stop Bit(s)</b>	Set RS-232 Stop Bits.	<b>1</b>



# 6.5.2 Ethernet

**Ethernet** configures internal Ethernet configuration and checks the printer's Ethernet module status, and reset the Ethernet module.

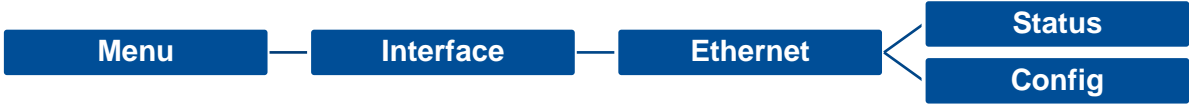

Item	Description	Default
Status	Check the Ethernet IP address and MAC setting status.	N/A
Config.	<b>DHCP:</b> On or OFF the DHCP (Dynamic Host Configuration Protocol) network protocol. <b>Static IP:</b> Use this menu to set the printer's IP address, subnet mask and gateway.	DHCP

### 6.5.3 Wi-Fi

Wi-Fi can set the printer Wi-Fi settings.

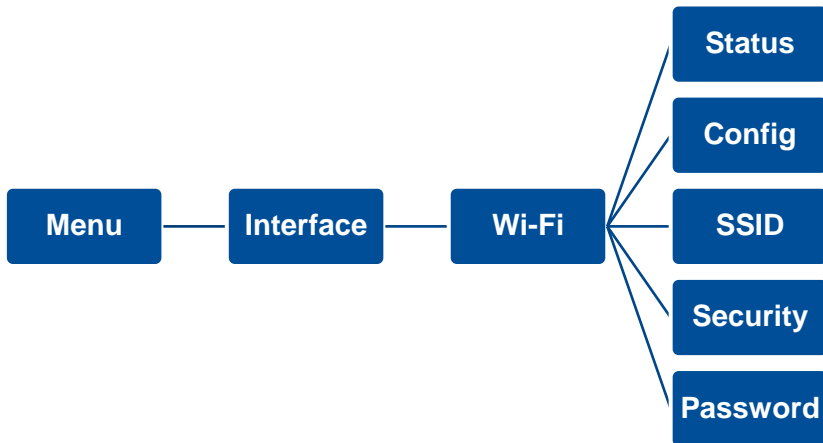

Item	Description	Default
Status	Check the Wi-Fi IP address, MAC setting status,... etc.	N/A
Config.	<b>DHCP:</b> ON/OFF the DHCP (Dynamic Host Configuration Protocol) network protocol. <b>Static IP:</b> Set the printer's IP address, subnet mask and gateway.	DHCP
SSID	Set Wi-Fi SSID.	N/A
Security	Set Wi-Fi security.	Open
Password	Set Wi-Fi password.	N/A

### 6.5.4 Bluetooth

Bluetooth can set the printer Bluetooth settings.

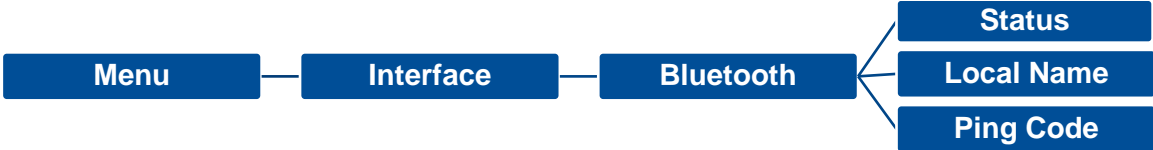

Item	Description	Default
Status	Check the Bluetooth status.	N/A
Local Name	Set the local name for Bluetooth.	RF-BHS
Ping Code	Set the local ping code for Bluetooth.	0000

# 6.6 Advanced

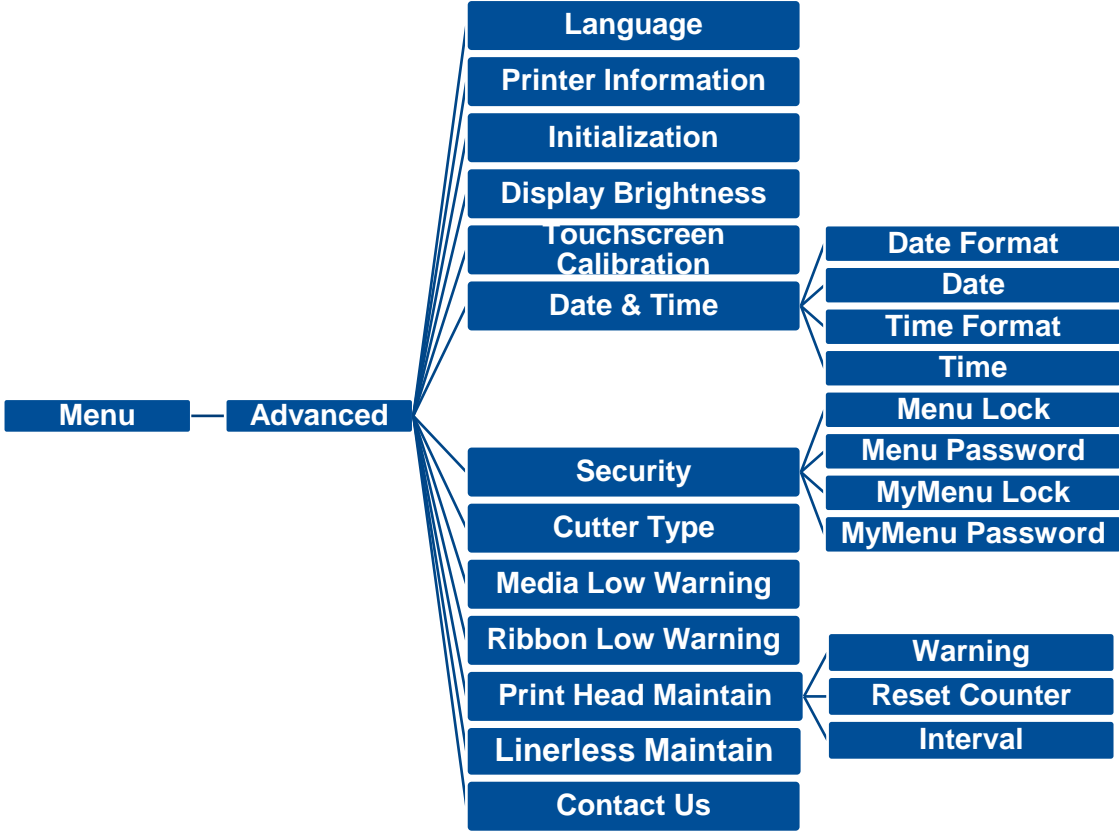

Item	Description	Default
<b>Language</b>	Switch the language on display.	<b>English</b>
<b>Printer Information</b>	Check the printer’s serial number, printed mileage (m), printed labels (pcs) and cutting counter.	<b>N/A</b>
<b>Initialization</b>	Restore printer settings to defaults.	<b>N/A</b>
<b>Display Brightness</b>	Set the brightness for display. Range: 0 to 100.	<b>50</b>
<b>Touchscreen Calibration</b>	Calibrate the touchscreen for best result.	<b>N/A</b>

Item	Description	Default
<b>Date &amp; Time</b>	Setup the date and time on display.	<b>N/A</b>
<b>Security</b>	Set the password for locking the menu or favorites. The default password is 8888.	<b>Disable</b>
<b>Cutter Type</b>	Set the cutter type.	<b>Guillotine</b>
<b>Ribbon Low Warning</b>	Set the warning for ribbon low. For example, if setting value is 30m, when ribbon capacity was lower than 30m, the  will be shown in red.	<b>30M</b>
<b>Print Head Maintain</b>	<p>Check printhead status and to set the settings for printhead care.</p> <p><b>Warning:</b> Enable/disable the printhead maintenance warning. If enable this feature, once printhead has been reached the setting mileage then the warning icon will be shown on printer UI for reminding user to clean the printhead. The default setting is disable.</p> <p><b>Reset Counter:</b> Reset the printhead clean warning mileage after cleaning printhead.</p> <p><b>Interval:</b> This item is used to set the expected mileage for reminding user to clean the printhead. You have to enable the “TPH warning lock” for use. The default setting is 1 km.</p> <p><b>Key sound:</b> This item is used to enable/disable the sound of front panel buttons.</p>	<b>N/A</b>

Item	Description	Default
<p><b>Linerless Maintain</b></p>	<p>Sets how often the linerless cutter blade should be cleaned.</p> <p><b>Warning:</b> Turns on/off notification that reminds users to clean the cutter blade if the set mileage for the cutter blade is fulfilled. (Default setting: ON)</p> <p><b>Interval:</b> Sets mileage for the cutter blade. When the set amount of mileage is fulfilled, the warning icon that reminds users to clean the cutter blade will appear on the display panel. (Default setting: 1 km)</p> <p><b>Clean Cutter Blade:</b> Lifts up to expose the cutter blade. Select this item to lift up the cutter blade if you need to clean the blade.</p> <p><b>NOTE:</b> For how to clean the linerless cutter blade, please refer to <a href="#">8 Maintenance</a> section for more information.</p> <p><b>CAUTION:</b> To avoid the risk of personal injury, keep your hands away from the cutter gate when selecting Clean Cutter Blade. Selecting this item will lift up the blade.</p> <p><b>Reset Counter:</b> Resets the mileage count after cleaning the cutter blade.</p> <p><b>Note:</b> These options can also be quickly accessed directly from “Favorites” to set them up.</p>	
<p><b>Contact us</b></p>	<p>Check the contact information for tech support service</p>	<p><b>N/A</b></p>

## 6.7 File Manager

**File Manager** is used to check the printer available memory, show the files list, delete the files or run the files that saved in the printer DRAM/Flash/Card memory.



# 6.8 Diagnostic

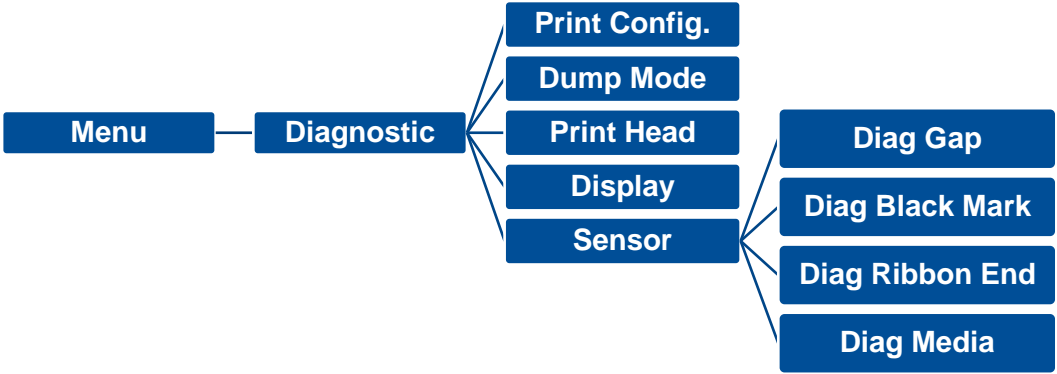

Item	Description
<b>Print Config.</b>	Print current printer configuration to the label. The configuration printout contains printhead test pattern, which is useful for checking the dot damage on the printhead heater.
<b>Dump Mode</b>	Captures the data from the communications port and prints out the data received by printer. In the dump mode, all characters will be printed in 2 columns. The left side characters are received from your system and right side data are the corresponding hexadecimal value of the characters. It allows users or engineers to verify and debug the program. <b>Dump mode requires 4" wide paper width.</b>
<b>Printhead</b>	Check printhead's temperature and bad dots.
<b>Display</b>	Check LCD's color state.
<b>Sensor</b>	Check sensors intensity and reading state.



# 6.9 Favorites

**Favorites** helps users build a commonly used list. Arrange the commonly used setting options by **Favorites** .

**Add items:** Touch and hold the item > window of **Join Favorites** will pop up > tap **Yes** to add the item to **Favorites**.

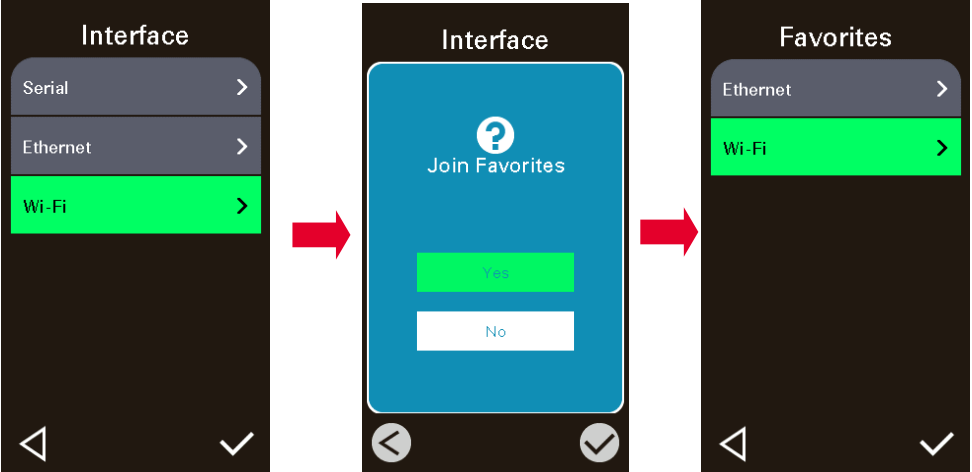

**Delete items:** Touch and hold the item > window of **Delete Favorites** will pop up > tap **Yes** to delete the item.

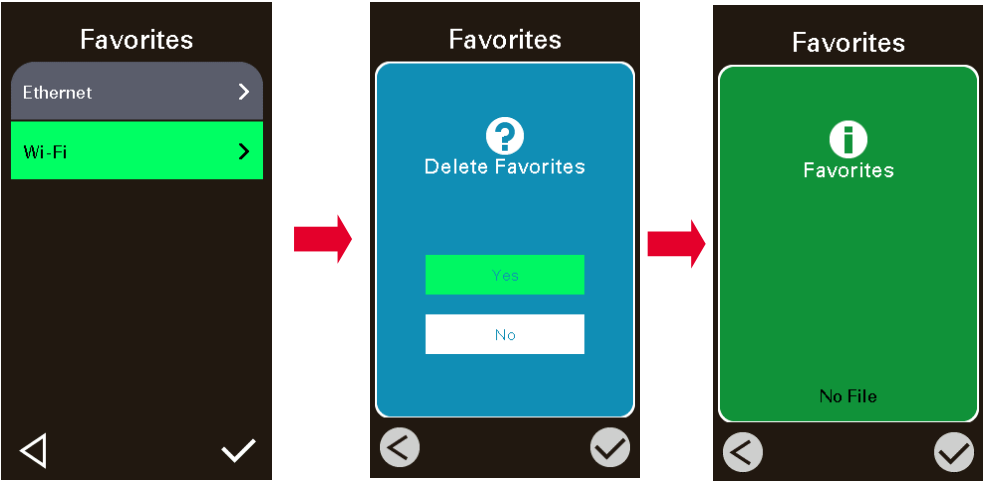

## 6.10 Configuring the Printer and Setting Options for the Linerless Media

1. After loading the linerless media into the printer, perform the calibration  to calibrate the media sensor (**Continuous**).
2. When the calibration is finished, enter the printer LCD Menu to configure the linerless printer. Select **Setting**. Make sure the **Command Set** is set to **TSPL**.  
For linerless tear module, select **Print Mode** and set the print mode to **Peeler Mode**.  
For linerless cutter module, select **Print Mode** and set the print mode to **Cutter Mode**.

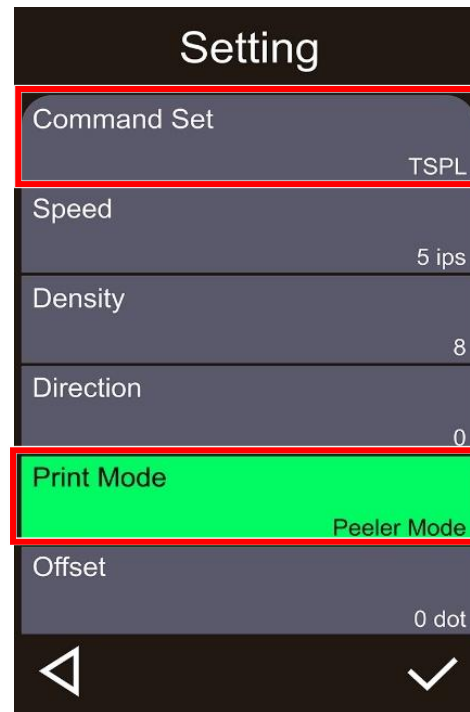

The following paragraph describes the setting options that help optimize the print quality when using the linerless media. The setting options will automatically appear in the **Favorites** folder after installing the linerless cutter/tear module onto the printer.

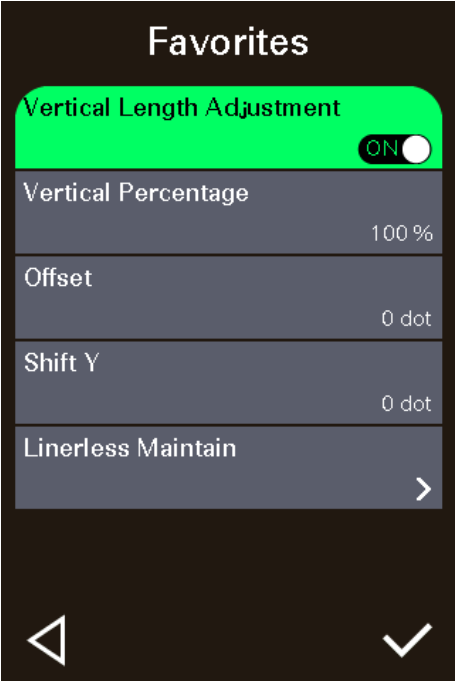

Item	Description
<b>Vertical Length Adjustment (ON)</b>	Turns on/off the <b>Vertical Length Adjustment</b> function. Setting option: <b>ON / OFF</b> .
<b>Vertical Percentage</b>	Adjusts the label length. This item will not appear if <b>Vertical Length Adjustment</b> is turned off. Setting range: 90 to 115%.
<b>Offset</b>	Specifies the stop position for each operation. Setting range: -203 to 203 dots.
<b>Shift Y</b>	Specifies the amount to shift an image vertically up or down for precise print position on the label. Setting range: -203 to 203 dots.

Item	Description
<p><b>Linerless Maintain</b></p>	<p>Sets how often the printer should be cleaned after printing with the linerless media.</p> <p><b>Warning:</b> Turns on/off notification that reminds users to clean the printer if the set mileage is fulfilled. (Default setting: ON)</p> <p><b>Interval:</b> Schedules printer maintenance after printing with the linerless media. When the set amount of mileage is fulfilled, the warning icon that reminds users to clean the printer will appear on the display panel. (Default setting: 1 km)</p> <p><b>Clean Cutter Blade:</b> Lifts up to expose the cutter blade. Select this item to lift up the cutter blade if you need to clean the blade.</p> <p><b>NOTE:</b> <b>Clean Cutter Blade</b> will be displayed in the menu after installing the cutter module on the printer. For how to clean the linerless cutter blade, please refer to <a href="#">8 Maintenance</a> section for more information.</p> <p><b>CAUTION:</b> To avoid the risk of personal injury, keep your hands away from the cutter gate when selecting <b>Clean Cutter Blade</b>. Selecting this item will lift up the blade.</p> <p><b>Reset Counter:</b> Resets the mileage count after cleaning the printer.</p>

# 7 Troubleshooting

Problem	Possible Cause	Recovery Procedure
<b>Power indicator does not illuminate</b>	<ul style="list-style-type: none"> <li>■ The power cord is not properly connected.</li> <li>■ The power switch is closed.</li> </ul>	<ul style="list-style-type: none"> <li>■ Plug the power cord in printer and outlet.</li> <li>■ Switch the printer on.</li> </ul>
<b>Carriage Open</b>	<ul style="list-style-type: none"> <li>■ The printer carriage is open.</li> </ul>	<ul style="list-style-type: none"> <li>■ Close the print carriage.</li> </ul>
<b>Not Printing</b>	<ul style="list-style-type: none"> <li>■ Check if interface cable is well connected.</li> <li>■ Check if wireless or Bluetooth device is well connected.</li> <li>■ The port in the Windows driver is not correct.</li> </ul>	<ul style="list-style-type: none"> <li>■ Re-connect cable to interface or change a new cable.</li> <li>■ Reset the wireless device setting.</li> <li>■ Select the correct printer port in the driver.</li> <li>■ Clean the printhead.</li> <li>■ Printhead's harness connector is not well connected with printhead. Turn off the printer and plug the connector again.</li> <li>■ Check your program if there is a command - PRINT at the end of the file and there must have CRLF at the end of each command line.</li> </ul>
<b>No print on the label</b>	<ul style="list-style-type: none"> <li>■ Label or ribbon is loaded not correctly.</li> <li>■ Use wrong type paper or ribbon</li> </ul>	<ul style="list-style-type: none"> <li>■ Follow the instructions in loading the media and ribbon.</li> <li>■ Ribbon and media are not compatible.</li> <li>■ Verify the ribbon-inked side.</li> <li>■ The print density setting is incorrect.</li> </ul>
<b>No Ribbon</b>	<ul style="list-style-type: none"> <li>■ Running out of ribbon.</li> <li>■ The ribbon is installed incorrectly.</li> </ul>	<ul style="list-style-type: none"> <li>■ Supply a new ribbon roll.</li> <li>■ Refer to user's manual to reinstall the ribbon.</li> </ul>
<b>No Paper</b>	<ul style="list-style-type: none"> <li>■ Running out of label.</li> <li>■ The label is installed incorrectly.</li> <li>■ Gap/black mark sensor is not calibrated.</li> </ul>	<ul style="list-style-type: none"> <li>■ Supply a new label roll.</li> <li>■ Refer to user's manual to reinstall the label roll.</li> <li>■ Calibrate the gap/black mark sensor.</li> </ul>
<b>Paper Jam</b>	<ul style="list-style-type: none"> <li>■ Gap/black mark sensor is not set properly.</li> <li>■ Make sure label size is set properly.</li> <li>■ Labels may be stuck inside the printer</li> </ul>	<ul style="list-style-type: none"> <li>■ Calibrate the media sensor.</li> <li>■ Set media size correctly.</li> <li>■ Remove the stuck label inside the printer mechanism.</li> </ul>

Problem	Possible Cause	Recovery Procedure
	mechanism.	
<b>Take Label</b>	<ul style="list-style-type: none"> <li>■ Peel function is enabled.</li> </ul>	<ul style="list-style-type: none"> <li>■ If peeler module is installed, please remove the label.</li> <li>■ If there is no peeler module in front of the printer, please switch off the printer and install it.</li> <li>■ Check if the connector is plugging correctly.</li> </ul>
<b>Can't downloading the file to memory (FLASH / DRAM/CARD)</b>	<ul style="list-style-type: none"> <li>■ The space of memory is full.</li> </ul>	<ul style="list-style-type: none"> <li>■ Delete unused files in the memory.</li> </ul>
<b>Poor Print Quality</b>	<ul style="list-style-type: none"> <li>■ Ribbon and media is loaded incorrectly.</li> <li>■ Dust or adhesive accumulation on the printhead.</li> <li>■ Print density is not set properly.</li> <li>■ Printhead element is damaged.</li> <li>■ Ribbon and media are incompatible.</li> <li>■ The printhead pressure is not set properly.</li> </ul>	<ul style="list-style-type: none"> <li>■ Reload the supply.</li> <li>■ Clean the printhead.</li> <li>■ Clean the platen roller.</li> <li>■ Adjust the print density and print speed.</li> <li>■ Run printer self-test and check the printhead test pattern if there is dot missing in the pattern.</li> <li>■ Change proper ribbon or proper label media.</li> <li>■ Adjust the printhead pressure adjustment knob.</li> <li>■ The release lever does not latch the printhead properly.</li> </ul>
<b>Missing printing on the left or right side of label</b>	<ul style="list-style-type: none"> <li>■ Wrong label size setup.</li> </ul>	<ul style="list-style-type: none"> <li>■ Set the correct label size.</li> </ul>
<b>Gray line on the blank label</b>	<ul style="list-style-type: none"> <li>■ The printhead is dirty.</li> <li>■ The platen roller is dirty.</li> </ul>	<ul style="list-style-type: none"> <li>■ Clean the printhead.</li> <li>■ Clean the platen roller.</li> <li>■ (Please refer to chapter 8)</li> </ul>
<b>Irregular printing</b>	<ul style="list-style-type: none"> <li>■ The printer is in Hex Dump mode.</li> <li>■ The RS-232 setting is incorrect.</li> </ul>	<ul style="list-style-type: none"> <li>■ Turn off and on the printer to skip the dump mode.</li> <li>■ Re-set the RS-232 setting.</li> </ul>
<b>Label feeding is not stable (skew) when printing</b>	<ul style="list-style-type: none"> <li>■ The media guide does not touch the edge of the media.</li> </ul>	<ul style="list-style-type: none"> <li>■ If the label is moving to the right side, please move the label guide to left.</li> <li>■ If the label is moving to the left side, please move the label guide to right.</li> </ul>

Problem	Possible Cause	Recovery Procedure
<b>Skip labels when printing</b>	<ul style="list-style-type: none"> <li>■ Label size is not specified properly.</li> <li>■ Sensor sensitivity is not set properly.</li> <li>■ The media sensor is covered with dust.</li> </ul>	<ul style="list-style-type: none"> <li>■ Check if label size is setup correctly.</li> <li>■ Calibrate the sensor by Auto Gap or Manual Gap options.</li> <li>■ Clear the GAP/Black mark sensor by blower.</li> </ul>
<b>Wrinkle Problem</b>	<ul style="list-style-type: none"> <li>■ Printhead pressure is incorrect.</li> <li>■ Ribbon installation is incorrect.</li> <li>■ Media installation is incorrect.</li> <li>■ Print density is incorrect.</li> <li>■ Media feeding is incorrect.</li> </ul>	<ul style="list-style-type: none"> <li>■ Please refer to the chapter 4.</li> <li>■ Please set the suitable density to have good print quality.</li> <li>■ Make sure the label guide touch the edge of the media guide.</li> </ul>
<b>RTC time is incorrect when reboot the printer</b>	<ul style="list-style-type: none"> <li>■ The battery has run down.</li> </ul>	<ul style="list-style-type: none"> <li>■ Check if there is a battery on the main board.</li> </ul>
<b>The left side printout position is incorrect</b>	<ul style="list-style-type: none"> <li>■ Wrong label size setup.</li> <li>■ The parameter Shift X in LCD menu is incorrect.</li> </ul>	<ul style="list-style-type: none"> <li>■ Set the correct label size.</li> <li>■ Press [Menu] → [Setting] → [Shift X] to fine tune the parameter of Shift X.</li> </ul>
<b>The printing position of small label is incorrect</b>	<ul style="list-style-type: none"> <li>■ Media sensor sensitivity is not set properly.</li> <li>■ Label size is incorrect.</li> <li>■ The parameter Shift Y in the LCD menu is incorrect.</li> <li>■ The vertical offset setting in the driver is incorrect.</li> </ul>	<ul style="list-style-type: none"> <li>■ Calibrate the sensor sensitivity again.</li> <li>■ Set the correct label size and gap size.</li> <li>■ Press [Menu] → [Setting] → [Shift Y] → to fine tune the parameter of Shift Y.</li> <li>■ Set the vertical offset in the driver if you're using BarTender.</li> </ul>
<b>LCD panel is dark and keys are not working</b>	<ul style="list-style-type: none"> <li>■ The cable between main PCB and LCD panel is loose.</li> </ul>	<ul style="list-style-type: none"> <li>■ Check if the cable between main PCB and LCD is secured or not.</li> </ul>
<b>LCD panel is dark but the LEDs are light</b>	<ul style="list-style-type: none"> <li>■ The printer initialization is unsuccessful.</li> </ul>	<ul style="list-style-type: none"> <li>■ Turn OFF and ON the printer again.</li> <li>■ Initialize the printer.</li> </ul>
<b>Ribbon encoder sensor doesn't work</b>	<ul style="list-style-type: none"> <li>■ The ribbon encoder sensor connector is loose.</li> </ul>	<ul style="list-style-type: none"> <li>■ Fasten the connector.</li> </ul>
<b>Ribbon end sensor doesn't work</b>	<ul style="list-style-type: none"> <li>■ The connector is loose.</li> <li>■ The ribbon sensor hole is covered with</li> </ul>	<ul style="list-style-type: none"> <li>■ Check the connector.</li> <li>■ Clear the dust in the sensor hole by the blower.</li> </ul>

Problem	Possible Cause	Recovery Procedure
	dust.	
<b>Cutter is not working</b>	<ul style="list-style-type: none"> <li>■ The connector is loose.</li> </ul>	<ul style="list-style-type: none"> <li>■ Plug in the connect cable correctly.</li> </ul>



# 8 Maintenance

This session presents the clean tools and methods to maintain the printer.

## ■ For Cleaning

Depending on the media used, the printer may accumulate residues (media dust, adhesives, etc.) as a by-product of normal printing. To maintain the best printing quality, you should remove these residues by cleaning the printer periodically. Regularly clean the printhead and supply sensors once change a new media to keep the printer at the optimized performance and extend printer life.

## ■ For Disinfecting

Sanitize your printer to protect yourself and others and can help prevent the spread of viruses.

## ■ Important

- Set the printer power switch to O (Off) prior to performing any cleaning or disinfecting tasks. Leave the power cord connected to keep the printer grounded and to reduce the risk of electrostatic damage.
- Do not wear rings or other metallic objects while cleaning any interior area of the printer.
- Use only the cleaning agents recommended in this document. Use of other agents may damage the printer and void its warranty.
- Do not spray or drip liquid cleaning solutions directly into the printer. Apply the solution on a clean lint-free cloth and then apply the dampened cloth to the printer.
- Do not use canned air in the interior of the printer as it can blow dust and debris onto sensors and other critical components.
- Only use a vacuum cleaner with a nozzle and hose that are conductive and grounded to drain off static build up.
- All reference in these procedures for use of isopropyl alcohol requires that a 99% or greater isopropyl alcohol content be used to reduce the risk of moisture corrosion to the printhead.
- Do not touch printhead by hand. If you touch it carelessly, please use 99% Isopropyl alcohol to clean it.
- Always taking personal precaution when using any cleaning agent.

## Cleaning Tools



- Cotton swab
- Lint-free cloth
- Brush with soft non-metallic bristles
- Vacuum cleaner
- 75% Ethanol (for disinfecting)
- 99% Isopropyl alcohol (for printhead and platen roller cleaning)
- Genuine printhead cleaning pen
- Mild detergent (without chlorine)







## Cleaning Process:

Printer Part	Method	Interval
<b>Printhead</b>	<ol style="list-style-type: none"> <li>I. Always turn off the printer before cleaning the printhead.</li> <li>II. Allow the printhead to cool for at least one minute.</li> <li>III. Use a cotton swab and 99% Isopropyl Alcohol or genuine printhead cleaning pen to clean the printhead surface.</li> </ol>	Clean the printhead when changing a new label roll.
<b>Standard Platen Roller</b>	<ol style="list-style-type: none"> <li>I. Turn off the printer.</li> <li>II. Rotate the platen roller and wipe it thoroughly with the lint-free 99% Isopropyl Alcohol.</li> </ol>	Clean the platen roller when changing a new label roll
<b>Peel Bar</b>	Use the lint-free cloth with 99% Isopropyl Alcohol to wipe it.	As needed
<b>Sensor</b>	Use brush with soft non-metallic bristles or a vacuum cleaner, to remove paper dust. Clean upper and lower media sensors to ensure reliable Top of Form and Paper Out sensing.	Monthly
<b>Exterior</b>	Clean the exterior surfaces with a clean, lint-free cloth (water-dampened cloth). If necessary, use a mild detergent or desktop cleaning solution then use the 75% Ethanol to wipe it.	As needed
<b>Interior</b>	Clean the interior of the printer by removing any dirt and lint with a vacuum cleaner, as described above, or use a brush with soft non-metallic bristles then use the 75% Ethanol to wipe it.	As needed

<p><b>Linerless Printer</b></p>	<p>Please refer to <a href="#">Linerless Cleaning Kit User Manual</a> for more information.</p> 	<ul style="list-style-type: none"><li>◆ Clean as needed or after printing every 1km.</li><li>◆ Please determine the maintenance intervals based on actual usage.</li></ul>
-------------------------------------	---	--

## 9 Agency Compliance and Approvals

	<p><b>EN 55032, Class A</b> <b>EN 55024</b> <b>EN 60950-1</b> <b>This is a class A product. In a domestic environment this product may cause radio interference in which case the user may be required to take adequate measures.</b></p>
	<p>FCC part 15B, Class A ICES-003, Class A This equipment has been tested and found to comply with the limits for a Class A digital device, pursuant to Part 15 of the FCC Rules. These limits are designed to provide reasonable protection against harmful interference when the equipment is operated in a commercial environment. This equipment generates, uses, and can radiate radio frequency energy and, if not installed and used in accordance with the manufacturer's instruction manual, may cause harmful interference with radio communications. Operation of this equipment in a residential area is likely to cause harmful interference, in which case you will be required to correct the interference at your own expense. This Class A digital apparatus complies with Canadian ICES-003. Cet appareil numérique de la classe A est conforme à la norme NMB-003 du Canada. This device complies with Part 15 of the FCC Rules. Operation is subject to the following two conditions: (1) This device may cause harmful interference, and (2) this device must accept any interference received, including interference that may cause undesired operation.</p>
	<p>AS/NZS CISPR 32, Class A</p>

	<p>UL 62368-1 CSA C22.2 No. 62368-1</p>
	<p>EN 62368-1</p>
	<p>KN 32 / KN 35 / K 60950-1 이 기기는 업무용(A 급) 전자파적합기기로서 판매자 또는 사용자는 이 점을 주의하시기 바라며, 가정외의 지역에서 사용하는 것을 목적으로 합니다.</p>
	<p>GB 4943.1 GB 9254, Class A GB 17625.1 此为 A 级产品，在生活环境中，该产品可能会造成无线电干扰，在这种情况下，可能需要用户对干扰采取切实可行的措施。</p>
	<p>Energy Star for Imaging Equipment Version 2.0</p>
	<p>IS 13252(Part 1)/ IEC 60950-1</p>
	<p>CNS 13438 CNS 14336-1 CNS 15663</p>
	<p>LP0002</p>

Note: There may have certification differences in the series models, please refer to product label for accuracy.

**Important safety instructions:**

1. Read all of these instructions and keep them for later use.
2. Follow all warnings and instructions on the product.
3. Disconnect the power plug from the AC outlet before cleaning or if fault happened.  
Do not use liquid or aerosol cleaners. Using a damp cloth is suitable for cleaning.
4. The mains socket shall be installed near the equipment and easily accessible.
5. The unit must be protected against moisture.
6. Ensure the stability when installing the device, Tipping or dropping could cause damage.
7. Make sure to follow the correct power rating and power type indicated on marking label provided by manufacture.
8. Please refer to user manual for maximum operation ambient temperature.

**WARNING:**

Hazardous moving parts, keep fingers and other body parts away.

**CAUTION:**

(For equipment with RTC (CR2032) battery or rechargeable battery pack)

Risk of explosion if battery is replaced by an incorrect type.

Dispose of used batteries according to the Instructions as below.

1. DO NOT throw the battery in fire.
2. DO NOT short circuit the contacts.
3. DO NOT disassemble the battery.
4. DO NOT throw the battery in municipal waste.
5. The symbol of the crossed out wheeled bin indicates that the battery should not be placed in municipal waste.



**Caution:** The printhead may be hot and could cause severe burns. Allow the printhead to cool.

**WARNING:**

For operation safety, please turn off the power by the power switch before opening the media cover to load labels, ribbons, or to

repair. After completing the steps, please close the media cover first and then turn on the power to start printing.

**CAUTION:**

Any changes or modifications not expressly approved by the grantee of this device could void the user's authority to operate the equipment.

**Below statement are for product with optional RF function.**

**CE Statement:**

This equipment complies with EU radiation exposure limits set forth for an uncontrolled environment. This equipment should be installed and operated with minimum distance 20 cm between the radiator & your body.

All operational modes:

2.4GHz: 802.11b, 802.11g, 802.11n (HT20), 802.11n (HT40)

5GHz: 802.11a,

The frequency, mode and the maximum transmitted power in EU are listed below:

2400 MHz – 2483.5 MHz: 19.88 dBm (EIRP)(Wi-Fi)

5150 MHz – 5250 MHz: 17.51 dBm (EIRP)(Wi-Fi)

2402 MHz – 2480 MHz: 6.02 dBm (EIRP)(Bluetooth)

Requirements in

AT/BE/BG/CZ/DK/EE/FR/DE/IS/IE/IT/EL/ES/CY/LV/LI/LT/LU/HU/MT/NL/NO/PL/PT/RO/SI/SK/TR/FI/SE/CH/UK/HR. 5150MHz-5350MHz is for indoor use only.

5150-5350MHz for Only indoor use

5470-5725MHz for indoor/outdoor use



**Restrictions In AZE**

**National restrictions information is provided below**

Frequency Band	Country	Remark
----------------	---------	--------

5150-5350MHz	Azerbaijan	No license needed if used indoor and power not exceeding 30mW
5470-5725MHz		

Hereby, TSC Auto ID Technology Co., Ltd. declares that the radio equipment type [Wi-Fi] IEEE 802.11 a/b/g/n is in compliance with Directive 2014/53/EU

The full text of the EU declaration of conformity is available at the following internet address:

<http://www.tscprinters.com/cms/theme/index-39.html>

### **RF exposure warning (Wi-Fi)**

This equipment must be installed and operated in accordance with provided instructions and must not be co-located or operating in conjunction with any other antenna or transmitter. End-users and installers must be providing with antenna installation instructions and transmitter operating conditions for satisfying RF exposure compliance.

SAR Value: 0.736 W/kg

### **RF exposure warning (For Bluetooth)**

The equipment complies with FCC RF exposure limits set forth for an uncontrolled environment.

The equipment must not be co-located or operating in conjunction with any other antenna or transmitter.

### **Canada, Industry Canada (IC) Notices**

This Class B digital apparatus complies with Canadian ICES-003 and RSS-210.

Operation is subject to the following two conditions: (1) this device may not cause interference, and (2) this device must accept any interference, including interference that may cause undesired operation of the device.

### **Radio Frequency (RF) Exposure Information**

The radiated output power of the Wireless Device is below the Industry Canada (IC) radio frequency exposure limits. The Wireless Device should be used in such a manner such that the potential for human contact during normal operation is minimized.

This device has been evaluated for and shown compliant with the IC Specific Absorption Rate (“SAR”) limits when installed in



specific host products operated in portable exposure conditions. **(For Wi-Fi)**

This device has also been evaluated and shown compliant with the IC RF Exposure limits under portable exposure conditions. (Antennas are less than 20 cm of a person's body). **(For Bluetooth)**

#### **Canada, avis de l'Industry Canada (IC)**

Cet appareil numérique de classe B est conforme aux normes canadiennes ICES-003 et RSS-210.

Son fonctionnement est soumis aux deux conditions suivantes : (1) cet appareil ne doit pas causer d'interférence et (2) cet appareil doit accepter toute interférence, notamment les interférences qui peuvent affecter son fonctionnement.

#### **Informations concernant l'exposition aux fréquences radio (RF)**

La puissance de sortie émise par l'appareil sans fil est inférieure à la limite d'exposition aux fréquences radio de l'Industry Canada (IC). Utilisez l'appareil sans fil de façon à minimiser les contacts humains lors du fonctionnement normal.

Ce périphérique a été évalué et démontré conforme aux limites SAR (Specific Absorption Rate – Taux d'absorption spécifique) par l'IC lorsqu'il est connecté à des dispositifs hôtes spécifiques opérant dans des conditions d'utilisation mobile. **(Pour le Wi-Fi)**

Ce périphérique a également été évalué et démontré conforme aux limites d'exposition radio-fréquence par l'IC pour des utilisations par des opérateurs mobiles (les antennes sont à moins de 20 cm du corps d'une personne). **(Pour le Bluetooth)**

#### **NCC 警語:**

經型式認證合格之低功率射頻電機，非經許可，公司、商號或使用者均不得擅自變更頻率、加大功率或變更原設計之特性及功能。(即

低功率電波輻射性電機管理辦法第十二條)

低功率射頻電機之使用不得影響飛航安全及干擾合法通信；經發現有干擾現象時，應立即停用，並改善至無干擾時方得繼續使用。

前項合法通信，指依電信法規定作業之無線電通信。低功率射頻電機須忍受合法通信或工業、科學及醫療用電波輻射性電機設備之干擾。(即低功率電波輻射性電機管理辦法第十四條)

### **BSMI Class A 警語:**

這是甲類的資訊產品，在居住的環境使用中時，可能會造成射頻 干擾，在這種情況下，使用者會被要求採取某些適當的對策。

### MFi for Bluetooth



Use of the Made for Apple badge means that an accessory has been designed to connect specifically to the Apple product(s) identified in the badge, and has been certified by the developer to meet Apple performance standards. Apple is not responsible for the operation of this device or its compliance with safety and regulatory standards.

### For US Model

Made for iPhone®XS Max, iPhone XS, iPhone XR, iPhone X, iPhone 8, iPhone 8 Plus, iPhone 7, iPhone 7 Plus, iPhone SE, iPhone 6s, iPhone 6s Plus, iPhone 6, iPhone 6 Plus, iPhone 5s, iPad Pro® 12.9-inch (2nd generation), iPad Pro 10.5-inch, iPad® (6th generation), iPad (5th generation), iPad Pro 9.7-inch, iPad Pro 12.9-inch (1st generation), iPad Air® 2, iPad mini™ 4, iPad mini 3, iPad Air, iPad mini 2, iPod touch® (6th generation)

iPad, iPad Air, iPad Pro, iPhone are trademarks of Apple Inc., registered in the U.S. and other countries.

### For JP Model

Made for iPhone XS Max, iPhone XS, iPhone XR, iPhone X, iPhone 8, iPhone 8 Plus, iPhone 7, iPhone 7 Plus, iPhone SE, iPhone 6s, iPhone 6s Plus, iPhone 6, iPhone 6 Plus, iPhone 5s, iPad Pro 12.9-inch (2nd generation), iPad Pro 10.5-inch, iPad (6th generation), iPad (5th generation), iPad Pro 9.7-inch, iPad Pro 12.9-inch (1st generation), iPad Air 2, iPad mini 4, iPad mini 3, iPad Air, iPad mini 2, iPod touch (6th generation)

iPad, iPad Air, iPad Pro, iPhone are trademarks of Apple Inc., registered in the U.S. and other countries. The trademark “iPhone” is used in Japan with a license from Aiphone K.K.

### Except for US, JP Model

Made for iPhone XS Max, iPhone XS, iPhone XR, iPhone X, iPhone 8, iPhone 8 Plus, iPhone 7, iPhone 7 Plus, iPhone SE, iPhone 6s, iPhone 6s Plus, iPhone 6, iPhone 6 Plus, iPhone 5s, iPad Pro 12.9-inch (2nd generation), iPad Pro 10.5-inch, iPad (6th generation), iPad (5th generation), iPad Pro 9.7-inch, iPad Pro 12.9-inch (1st generation), iPad Air 2, iPad mini 4, iPad mini 3, iPad Air, iPad mini 2, iPod touch (6th generation)

iPad, iPad Air, iPad Pro, iPhone are trademarks of Apple Inc., registered in the U.S. and other countries.

# 10 Revision History

Date	Content	Editor
2023/06/16	<ul style="list-style-type: none"><li>• Revised the “Product Specification” table from page 2.</li><li>• Added the “Loading the Linerless Media” section from page 23 to 25.</li><li>• Added the “Linerless Maintain” function in the “Advanced” section on page 58.</li><li>• Added the “Configuring the Printer and Setting Options for the Linerless Media” section from page 61 to 63.</li><li>• Added the “Cleaning the Printer after Linerless Printing” section from page 69 to 75.</li></ul>	Peter Yao
2023/08/09	<ul style="list-style-type: none"><li>• Removed CD disk from the specification table, page 4.</li><li>• Removed CD disk from the packing list, page 5.</li></ul>	Peter Yao
2024/3/11	<ul style="list-style-type: none"><li>• Modified the “Loading the Linerless Media (Optional)”, “Advanced”, “Favorites”, “Configuring the Printer and Setting Options for the Linerless Media” and “Maintenance” sections (for Linerless)</li></ul>	Camille Pao



[www.tscprinters.com](http://www.tscprinters.com)