

Desktop Barcode Printer

TH240/DH240 Series

Thermal Transfer • Direct Thermal

Series Models

TH240 / TH340

TH240T / TH340T

TH240THC / TH340THC

DH240T / DH340T

DH240THC / DH340THC



User Manual

Copyright

©2023 TSC Auto ID Technology Co., Ltd.

The copyright in this manual, the software and firmware in the printer described are owned by TSC Auto ID Technology Co., Ltd. All rights reserved.

CG Triumvirate is a trademark of Agfa Corporation. CG Triumvirate Bold Condensed font is under license from the Monotype Corporation. Windows is a registered trademark of Microsoft Corporation.

All other trademarks are the property of their respective owners. Information in this document is subject to change without notice and does not represent a commitment on the part of TSC Auto ID Technology Co. No part of this manual may be reproduced or transmitted in any form or by any means, for any purpose other than the purchaser's personal use, without the expressed written permission of TSC Auto ID Technology Co.



Contents

- 1 Introduction 3**
 - 1.1 Specifications 4
- 2 Unpacking and Inspecting 12**
- 3 Getting to Know Your Printer 13**
 - 3.1 Front View 13
 - 3.2 Inner View 16
 - 3.3 Rear View 18
- 4 Setting up the Printer 20**
 - 4.1 Connecting the Power Cable and Adapter 20
 - 4.2 Loading the Media 21
 - 4.3 Loading the Ribbon (for TH240 Series only) 26
 - 4.4 Loading the Media in Peel-off Mode (Optional) 29
 - 4.5 Loading the Media in Cutter Mode (Optional) 31
- 5 Operator Interface 33**
 - 5.1 LED User Interface 33
 - 5.2 LCD User Interface 37
 - 5.3 Web User Interface 41
- 6 TSC Console 47**
 - 6.1 Launching TSC Console 47
 - 6.2 Adding Ethernet Interface 49
 - 6.3 Adding Wi-Fi Interface 52
 - 6.4 Initializing Printer's Wi-Fi Settings 56
 - 6.5 TPH Care 57
 - 6.6 Printer's Main Functions 59
 - 6.7 Configuring Optional Kits 60

7	Main Screen	61
7.1	Setting	62
7.2	Sensor	69
7.3	Interface	71
7.4	Advanced	74
7.5	File Manager	77
7.6	Diagnostic	78
7.7	Favorites	80
7.8	Configuring the Printer and Setting Options for the Linerless Media	82
8	Troubleshooting	85
8.1	Common Problems	85
9	Maintenance	90
9.1	Cleaning Supplies	91
9.2	Cleaning Procedures	92
10	Agency Compliance and Approvals	93
	Revision History	106

1 Introduction

Thank you very much for purchasing TSC barcode printer.

The TH/DH240 Series Desktop Barcode Printers are versatile and flexible for diverse printing requirements. This series' versatility enables printing a wide range of difficult labels, including thick, tiny, and long labels and certain types of vertical market labels.

Our printer language emulation makes the TH/DH240 Series plug-and-play. Its firmware automatically identifies major printer languages and begins printing immediately without changing label templates. The TH/DH240 Series minimizes downtime during daily operations through comprehensive printer management tools (Internal Embedded Webpage, virtual control panel, TSC Console, and SOTI Connect), printer shutdown prevention, and supports network security configurations to manage printers efficiently.

The TH/DH240 Series scales up applications with a wide media width, high-precision printing, and several addable future-proof options. This empowers businesses to adapt to changing requirements for present and future operations. The eco-friendly printer features 100% recyclable packaging and plastic printer casing. Over 90% of printer components are recyclable at the printer's end-of-life, reducing environmental impact.

This document provides an easy reference for operating this printer. TSC printers include the Windows labeling software for creating your label template. For system integration, the TSPL/TSPL2 printer programming manual or SDKs can be found on TSC website at: <https://www.tscprinters.com>.

1.1 Specifications

DH240 Series

Model (HC: Healthcare)	DH240T (HC)	DH340T (HC)
Resolution	8 dots/mm (203 dpi)	12 dots/mm (300 dpi)
Print Method	Direct Thermal	
Max. Print Speed	203 mm (8")/ second Peel mode: 76 mm (3")/ second	152 mm (6")/ second Peel mode: 76 mm (3")/ second
Max. Print Width	108 mm (4.25")	105.7 mm (4.16")
Max. Print Length	25,400 mm (1,000")	11,430 mm (450")
Enclosure	<ul style="list-style-type: none"> ▪ Clamshell with double-walled plastic ▪ Disinfectant-ready, designed with an easy-to-clean surface and a sealed button interface (for healthcare models only) ▪ Antibacterial enclosure (for healthcare models only) 	
Dimension	208 mm (width) x 170 mm (height) x 235 mm (depth) 8.19" (width) x 6.69" (height) x 9.25" (depth)	
Weight	2.1 kg (4.63 lbs.)	
Label Roll Capacity	127 mm (5") OD	
Processor	32-bit RISC CPU	
Memory	<ul style="list-style-type: none"> ▪ 128 MB Flash memory ▪ 128 MB SDRAM ▪ microSD card reader, max. 512 GB; supported format: FAT32 and exFAT only 	

Model (HC: Healthcare)	DH240T (HC)	DH340T (HC)
I/O & Connectivity	<ul style="list-style-type: none"> ▪ USB 2.0 ▪ RS-232 ▪ USB Host ▪ Ethernet LAN port (10/100 Mbps) ▪ 802.11 a/b/g/n/ac Wi-Fi with Bluetooth 5.0 combo module (dealer option) ▪ Bluetooth 5.0 (dealer option) ▪ MFi Bluetooth 5.0 (factory option) 	
Power	External universal switching power supply: <ul style="list-style-type: none"> ▪ IEC 60601-1 certified power supply (for healthcare models only) ▪ Input: AC 100-240V, 2.0A, 50-60Hz ▪ Output: DC 24V, 3.75A, 90W 	
LCD Display	3.5" color touch display (resolution 480 x 320)	
Button	<ul style="list-style-type: none"> ▪ Power switch x1 ▪ Feed button x1 ▪ Pause button x1 ▪ Reprint button x1 	
Sensor	<ul style="list-style-type: none"> ▪ Transmissive gap sensor ▪ Black mark reflective sensor (adjustable position) ▪ Printhead open sensor 	
Real Time Clock (RTC)	Standard	
Built-in Fonts	<ul style="list-style-type: none"> ▪ 8 alpha-numeric bitmap fonts ▪ Monotype Image® true type font engine with one CG Triumvirate Bold Condensed scalable font ▪ ARIALUNI.TTF Unicode true type font 	

Model (HC: Healthcare)	DH240T (HC)	DH340T (HC)
Supported Barcode Formats	<ul style="list-style-type: none"> • 1D Barcodes Code 39, Code 93, Code128UCC, Code128 subsets A.B.C, Codabar, Interleaved 2 of 5, EAN 8, EAN 13, EAN 128, UPC-A, UPC-E, EAN and UPC 2(5) digits add-on, MSI, PLESSEY, POSTNET, China post, ITF14, EAN14, Code 11, TELEPEN, TELEPENN, PLANET, Code 49, Deutsche Post Identcode, Deutsche Post Leitcode, LOGMARS • 2D Barcodes TLC39, CODABLOCK F mode, PDF-417, Maxicode, DataMatrix, QR code, Aztec, Micro PDF 417, GS1 DataBar (RSS barcode) 	
Font & Barcode Orientation	0 / 90 / 180 / 270 degree	
Printer Language	TSPL-EZD (compatible to EPL, ZPL, ZPL II, and DPL)	
Media Type	Continuous, Die-cut, Black mark, Fanfold, Notch (outside wound), Linerless Media (for linerless option)	
Media Width	15 – 120 mm (0.59" – 4.72") Peel mode and Cutter mode: 15 – 112 mm (0.59" – 4.40"), including the liner	
Media Thickness	0.06 – 0.19 mm (2.36 – 7.48 mil) Linerless media: 0.06 – 0.10 mm (2.36" – 3.937 mil)	
Media Core Diameter	25.4 – 38.1 mm (1" – 1.5")	
Label Length	5 – 25,400 mm (0.2" – 1,000") Peel mode: 25.4 – 152.4 mm (1" – 6") Cutter mode: 25.4 – 25,400 mm (1" – 1000") Linerless cutter mode: 25.4 – 152.4 mm (1" – 6") Linerless tear mode: 50.8 – 152.4 mm (2" – 6")	5 – 11,430 mm (0.2" – 450") Peel mode: 25.4 – 152.4 mm (1" – 6") Cutter mode: 25.4 – 11,430 mm (1" – 450") Linerless cutter mode: 25.4 – 152.4 mm (1" – 6") Linerless tear mode: 50.8 – 152.4 mm (2" – 6")
Environment Condition	<ul style="list-style-type: none"> ▪ Operation: 0 to 40°C (32 to 104°F), 25 to 85% (non-condensing) ▪ Storage: -40 to 60°C (-40 to 140°F), 10 to 90% (non-condensing) ▪ Linerless print: 5 to 35°C (41 to 95°F), 25 to 75% (non-condensing) 	

Model (HC: Healthcare)	DH240T (HC)	DH340T (HC)
Accessories	<ul style="list-style-type: none"> ▪ Quick start guide x1 ▪ USB cable x1 ▪ Power cord x1 ▪ External universal switching power supply x1 	
Factory Options	MFi Bluetooth 5.0	
Dealer Options	<ul style="list-style-type: none"> ▪ Peel-off module ▪ Guillotine cutter (full cut and partial cut) ▪ 802.11 a/b/g/n/ac Wi-Fi with Bluetooth 5.0 combo module ▪ Bluetooth 5.0 module ▪ Linerless with cutter (full cut) ▪ Linerless with tear 	
User Options	<ul style="list-style-type: none"> ▪ External label roll mount ▪ KP-200 Plus keyboard display unit ▪ 10 mm narrow media adapter 	

TH240 Series

Model (HC: Healthcare)	TH240	TH340	TH240T (HC)	TH340T (HC)
Resolution	8 dots/mm (203 dpi)	12 dots/mm (300 dpi)	8 dots/mm (203 dpi)	12 dots/mm (300 dpi)
Print Method	Thermal Transfer & Direct Thermal			
Max. Print Speed	203 mm (8")/ second Peel mode: 76 mm (3")/ second	152 mm (6")/ second Peel mode: 76 mm (3")/ second	203 mm (8")/ second Peel mode: 76 mm (3")/ second	152 mm (6")/ second Peel mode: 76 mm (3")/ second
Max. Print Width	108 mm (4.25")	105.7 mm (4.17")	108 mm (4.25")	105.7 mm (4.17")
Max. Print Length	25,400 mm (1,000")	11,430 mm (450")	25,400 mm (1000")	11,430 mm (450")
Enclosure	<ul style="list-style-type: none"> ▪ Clamshell with double-walled plastic ▪ Disinfectant-ready, designed with an easy-to-clean surface and a sealed button interface (for healthcare models only) ▪ Antibacterial enclosure (for healthcare models only) 			
Dimension	223 mm (width) x 186 mm (height) x 286 mm (depth) 8.78" (width) x 7.32" (height) x 11.26" (depth)			
Weight	2.8 kg (6.17 lbs.)			
Label Roll Capacity	127 mm (5") OD			
Ribbon	<ul style="list-style-type: none"> ▪ 300 m long, max. OD 67 mm, 1" core (ink coated outside) ▪ 110 m long, max. OD 40 mm, 0.5" core (ink coated outside) 			
Ribbon Width	40 – 110 mm (1.6" – 4.3")			
Processor	32-bit RISC CPU			
Memory	<ul style="list-style-type: none"> ▪ 128 MB Flash memory ▪ 128 MB SDRAM ▪ microSD card reader, max. 512 GB; supported format: FAT32 and exFAT only 			

Model (HC: Healthcare)	TH240	TH340	TH240T (HC)	TH340T (HC)
I/O & Connectivity	<ul style="list-style-type: none"> ▪ USB 2.0 ▪ RS-232 ▪ USB Host ▪ Ethernet LAN port (10/100 Mbps) ▪ 802.11 a/b/g/n/ac Wi-Fi with Bluetooth 5.0 combo module (dealer option) ▪ Bluetooth 5.0 (dealer option) ▪ MFi Bluetooth 5.0 (factory option) 			
Power	External universal switching power supply: <ul style="list-style-type: none"> ▪ IEC 60601-1 certified power supply (for healthcare models only) ▪ Input: AC 100-240V, 2.0A, 50-60Hz ▪ Output: DC 24V, 3.75A, 90W 			
LCD Display	Not available	Not available	3.5" color touch display (resolution 480 x 320)	3.5" color touch display (resolution 480 x 320)
Button & LED	<ul style="list-style-type: none"> ▪ Power switch x1 ▪ Feed button x1 ▪ Pause button x1 ▪ Reprint button x1 ▪ Status indicator x1 ▪ Intuitive icon indicator x4 		<ul style="list-style-type: none"> ▪ Power switch x1 ▪ Feed button x1 ▪ Pause button x1 ▪ Reprint button x1 	
Sensor	<ul style="list-style-type: none"> ▪ Transmissive gap sensor ▪ Black mark reflective sensor (adjustable position) ▪ Ribbon end sensor ▪ Printhead open sensor 			
Real Time Clock (RTC)	Standard			
Built-in Fonts	<ul style="list-style-type: none"> ▪ 8 alpha-numeric bitmap fonts ▪ Monotype Image® true type font engine with one CG Triumvirate Bold Condensed scalable font ▪ ARIALUNI.TTF Unicode true type font 			

Model (HC: Healthcare)	TH240	TH340	TH240T (HC)	TH340T (HC)
Supported Barcode Formats	<ul style="list-style-type: none"> 1D Barcodes Code 39, Code 93, Code128UCC, Code128 subsets A.B.C, Codabar, Interleaved 2 of 5, EAN 8, EAN 13, EAN 128, UPC-A, UPC-E, EAN and UPC 2(5) digits add-on, MSI, PLESSEY, POSTNET, China post, ITF14, EAN14, Code 11, TELEPEN, TELEPENN, PLANET, Code 49, Deutsche Post Identcode, Deutsche Post Leitcode, LOGMARS 2D Barcodes TLC39, CODABLOCK F mode, PDF-417, Maxicode, DataMatrix, QR code, Aztec, Micro PDF 417, GS1 DataBar (RSS barcode) 			
Font & Barcode Orientation	0 / 90 / 180 / 270 degree			
Printer Language	TSPL-EZD (compatible to EPL, ZPL, ZPL II, and DPL)			
Media Type	Continuous, Die-cut, Black mark, Fanfold, Notch (outside wound)			
Media Width	15 – 120 mm (0.59” – 4.72”) Peel mode and Cutter mode: 15 – 112 mm (0.59” – 4.40”), including the liner			
Media Thickness	0.06 – 0.19 mm (2.36 – 7.48 mil) Care label media: 0.06 – 0.10 mm (2.36” – 3.937 mil)			
Media Core Diameter	25.4 – 38.1 mm (1” – 1.5”)			
Label Length	<ul style="list-style-type: none"> 5 – 25,400 mm (0.2” – 1,000”) Peel mode: 25.4 – 152.4 mm (1” – 6”) Cutter mode: 25.4 – 25,400 mm (1” – 1000”) 	<ul style="list-style-type: none"> 5 – 11,430 mm (0.2” – 450”) Peel mode: 25.4 – 152.4 mm (1” – 6”) Cutter mode: 25.4 – 11,430 mm (1” – 450”) 	<ul style="list-style-type: none"> 5 – 25,400 mm (0.2” – 1,000”) Peel mode: 25.4 – 152.4 mm (1” – 6”) Cutter mode: 25.4 – 25,400 mm (1” – 1000”) 	<ul style="list-style-type: none"> 5 – 11,430 mm (0.2” – 450”) Peel mode: 25.4 – 152.4 mm (1” – 6”) Cutter mode: 25.4 – 11,430 mm (1” – 450”)
Environment Condition	<ul style="list-style-type: none"> Operation: 0 to 40°C (32 to 104°F), 25 to 85% (non-condensing) Storage: -40 to 60°C (-40 to 140°F), 10 to 90% (non-condensing) Care label print: 20°C (68°F), 65% (non-condensing) 			

Model (HC: Healthcare)	TH240	TH340	TH240T (HC)	TH340T (HC)
Accessories	<ul style="list-style-type: none"> ▪ Quick start guide x1 ▪ USB cable x1 ▪ Power cord x1 ▪ External universal switching power supply x1 ▪ 1" Ribbon paper core x1 ▪ 1" Ribbon spindle x2 (for 300 m ribbon roll) ▪ Media adapter for 120 mm wide media 			
Factory Options	MFi Bluetooth 5.0			
Dealer Options	<ul style="list-style-type: none"> ▪ Peel-off module ▪ Guillotine cutter module (full cut and partial cut) ▪ Care label cutter (full cut) (not available for healthcare models) ▪ 802.11 a/b/g/n/ac Wi-Fi with Bluetooth 5.0 combo module ▪ Bluetooth 5.0 module 			
User Options	<ul style="list-style-type: none"> ▪ External label roll mount ▪ KP-200 Plus keyboard display unit ▪ 10 mm narrow media adapter 			

2 Unpacking and Inspecting

The printer has been specially packaged to withstand damage during shipment. Retaining the packaging materials is recommended in case you need to ship the printer. When unpacking, ensure that you have received all the following items:

- Barcode printer x1
(The image for the printer is used for reference only.
The product appearance is based on the model you purchase.)
- Auto switch power adapter x1
- Power cord x1
- USB interface cable x1
- User Setup Guide x1
- Ribbon spindle x2 (TH240 series only)
- Paper core x1 (TH240 series only)
- Adapter for 120 mm wide media x2 (TH240 series only)

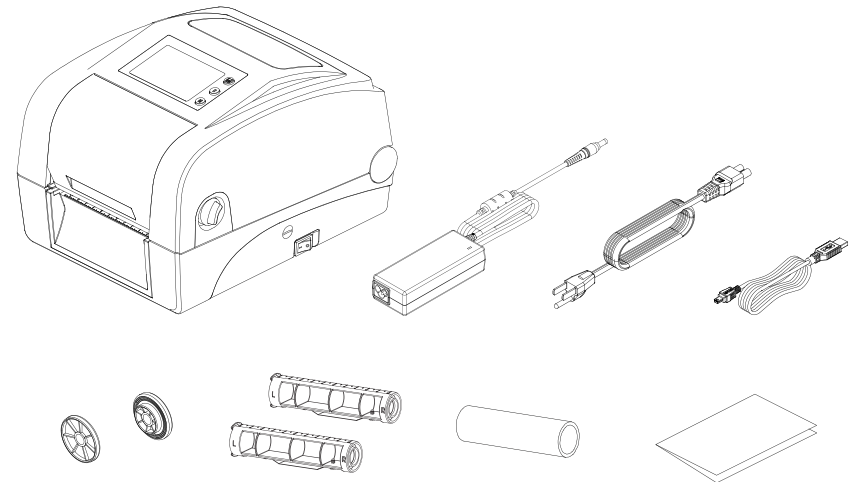

NOTE: If anything is missing or damaged, please contact the customer service department of your reseller or distributor.

3 Getting to Know Your Printer

3.1 Front View

TH240 Series with LCD Panel



1. LCD
2. Ribbon access cover
3. Media viewer window
4. Reprint button
5. Pause button
6. Feed button
7. Cover release lever
8. microSD card slot
9. Power switch

TH240 Series with LED Panel



- 1. Icon LEDs
- 2. LED indicator
- 3. Ribbon access cover
- 4. Media viewer window
- 5. Reprint button
- 6. Pause button
- 7. Feed button
- 8. Cover release lever
- 9. microSD card slot
- 10. Power switch

DH240 Series



- 1. LCD
- 2. Media viewer window
- 3. Reprint button
- 4. Pause button
- 5. Feed button
- 6. Cover release lever
- 7. microSD card slot
- 8. Power switch

3.2 Inner View

TH240 Series

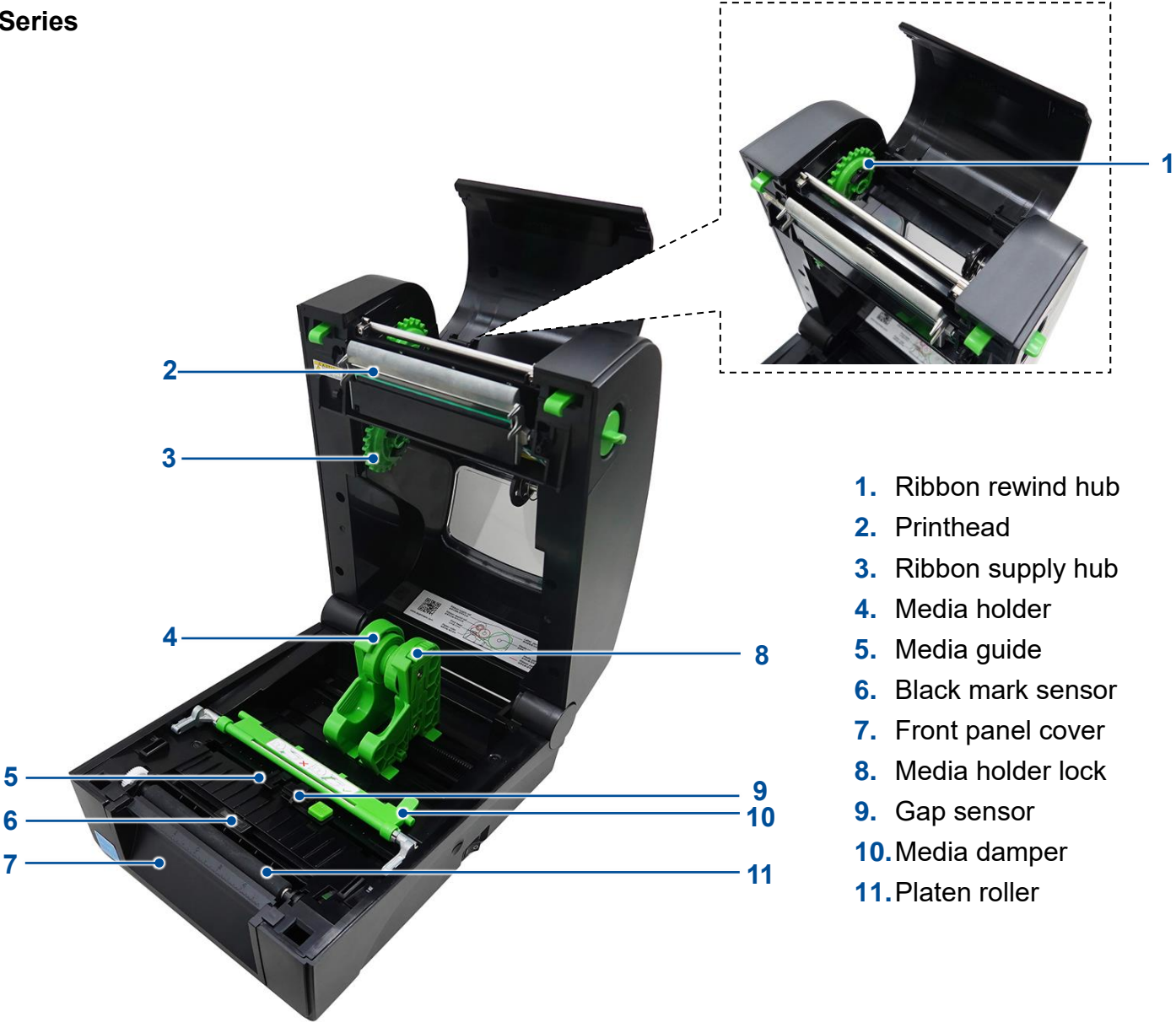

- 1. Ribbon rewind hub
- 2. Printhead
- 3. Ribbon supply hub
- 4. Media holder
- 5. Media guide
- 6. Black mark sensor
- 7. Front panel cover
- 8. Media holder lock
- 9. Gap sensor
- 10. Media damper
- 11. Platen roller

DH240 Series



- 1. Printhead
- 2. Upper black mark sensor
- 3. Media holder
- 4. Platen roller
- 5. Front panel cover
- 6. Media holder lock
- 7. Black mark sensor

3.3 Rear View

TH240 Series

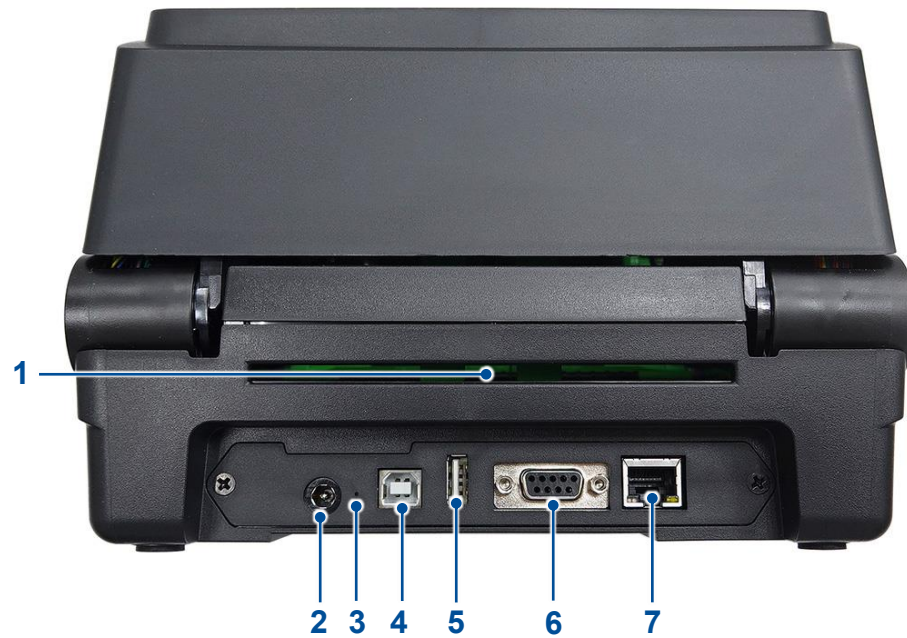

1. External label entrance chute
2. Power jack
3. Reset button
4. USB interface
5. USB host
6. RS-232C interface
7. Ethernet interface

DH240 Series



1. External label entrance chute
2. Power jack
3. Reset button
4. USB interface
5. USB host
6. RS-232C interface
7. Ethernet interface

4 Setting up the Printer

4.1 Connecting the Power Cable and Adapter

1. Place the printer on a flat surface.
2. Make sure the power switch on the right side of the printer is set to **OFF**.
3. Connect the printer to your computer using the supplied USB cable.
4. Connect the power cord to the power adapter.
5. Connect the power adapter to the DC-in port on the rear side of the printer.
IMPORTANT: Make sure the power switch on the right side of the printer is set to OFF before connecting the power adapter to the printer.
6. Fully insert the power cord plug into the power outlet socket.

4.2 Loading the Media

TH240 Series

1. Pull the cover release levers to open the printer's top cover.



2. Slightly pull to separate the media holders.



3. Load the media roll into the printer ensuring that the printable side of the media faces up.



4. Release the media holders ensuring that the media is properly secured and rolls smoothly.



5. Open the media damper.

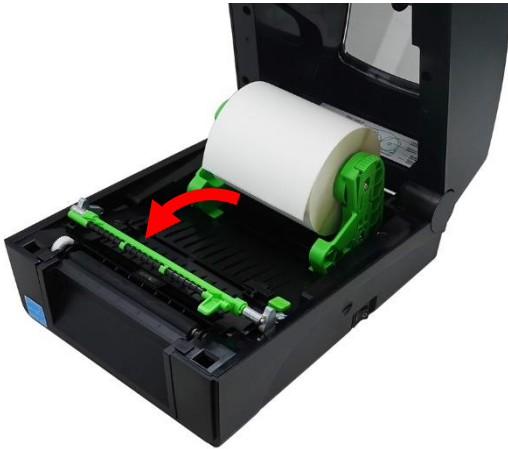

6. Pull the media and thread it through under the media damper until the media extends out of the front panel of the printer.

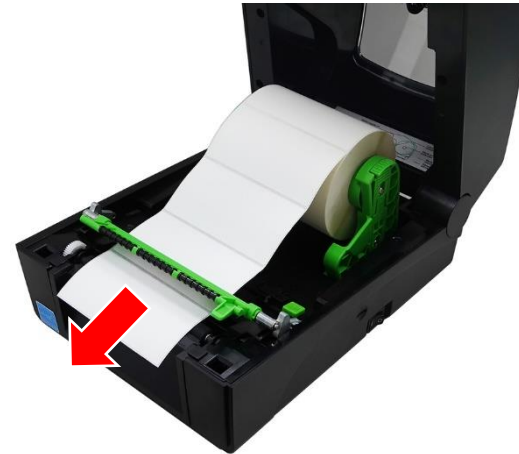

7. Press the media guide adjustment button to move the media guides until the guides fit the width of the media.

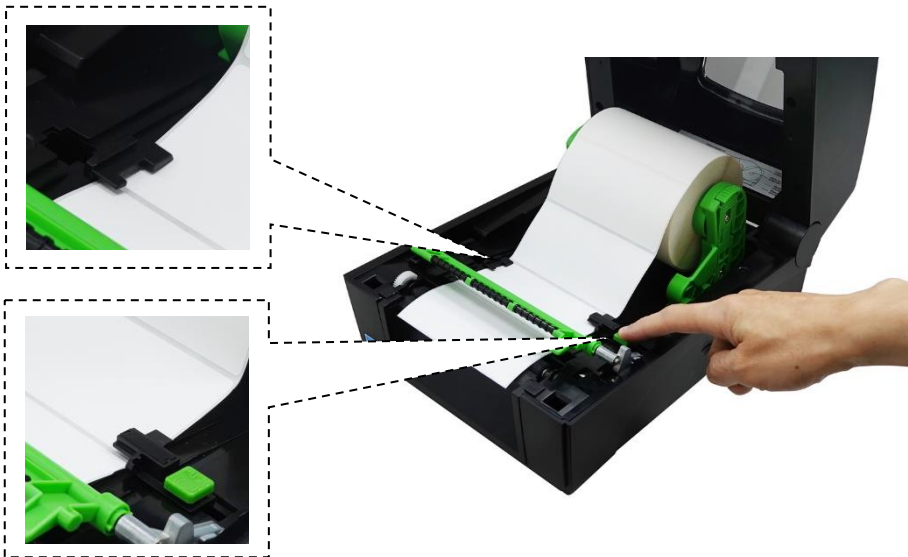

8. Close the media damper.

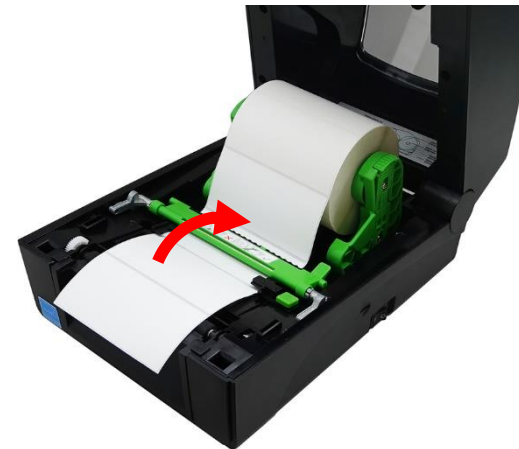

9. Gently close the top cover until it clicks into place.



10. Perform a media calibration for the media in use. For how to perform a media calibration, please refer to 7.2 Sensor.

DH240 Series

1. Pull the cover release levers to open the printer's top cover.



2. Slightly pull to separate the media holders.



3. Load the media roll into the printer ensuring that the printable side of the media faces up.



4. Rotate the media to make sure that the media is properly secured and rolls smoothly.



5. Pull the media until it extends out of the front panel of the printer. 6. Gently close the top cover until it clicks into place.

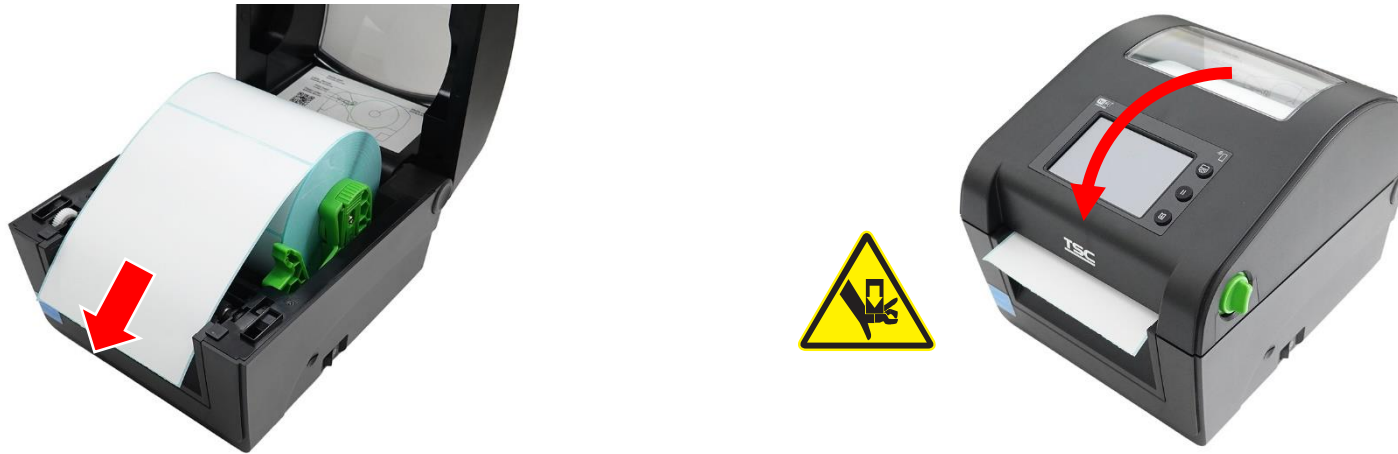

7. Perform a media calibration for the media in use. For how to perform a media calibration, please refer to 7.2 Sensor.

NOTE: The illustration below describes the media path for the DH240 series printers.

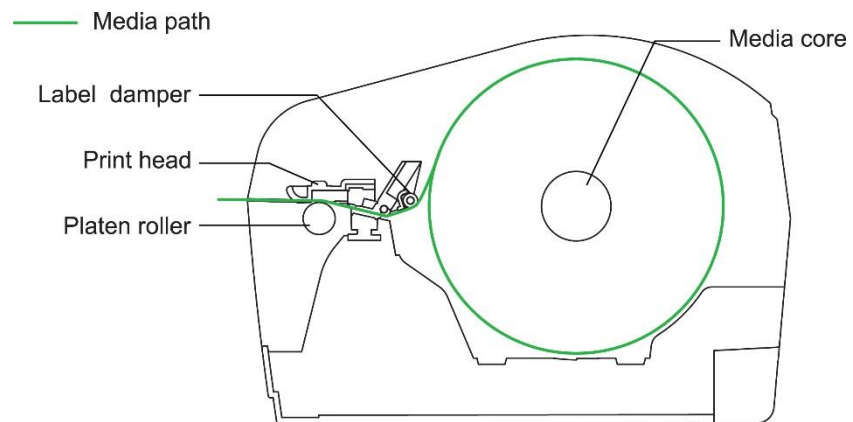

4.3 Loading the Ribbon (for TH240 Series only)

1. Pull the release latches to open the printer's top cover.



2. Open the ribbon access cover.

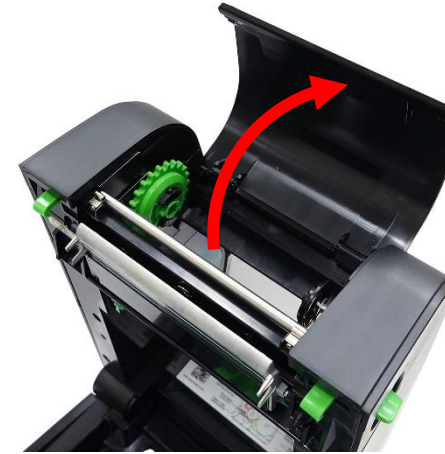

3. Orient the core adapter as indicated and then insert the core adapter into the supplied rewind paper core.

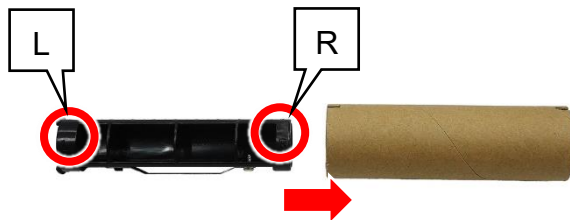

4. Push the right side of the paper core onto the right spring-loaded spindle and then align the left side of the paper core with the left spindle's hub ensuring that the square rib on the core adapter fits into the left spindle.

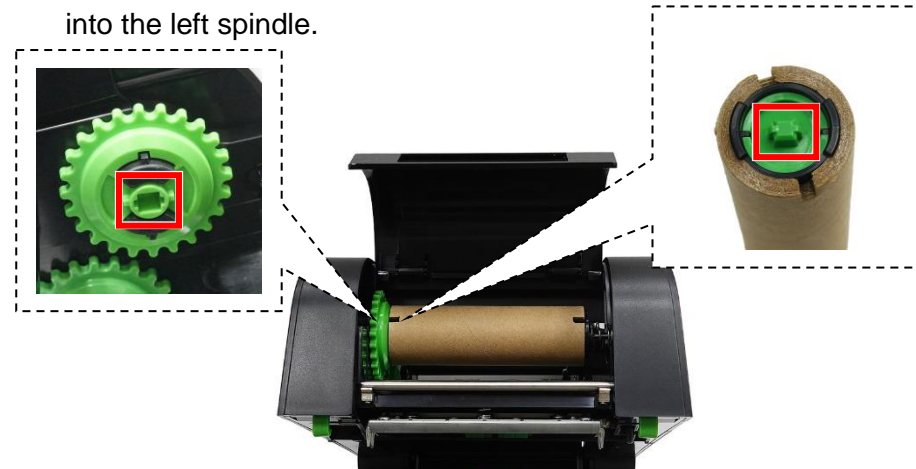

5. Orient the core adapter as indicated and then insert the core adapter into the ribbon core.

NOTE: This step is only applicable to the 1-inch ribbon core. Skip this step if the ribbon features a 0.5-inch core.

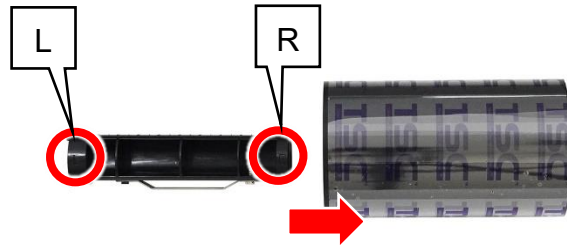

6. Repeat the procedures described in step 4 to load the ribbon into its compartment.

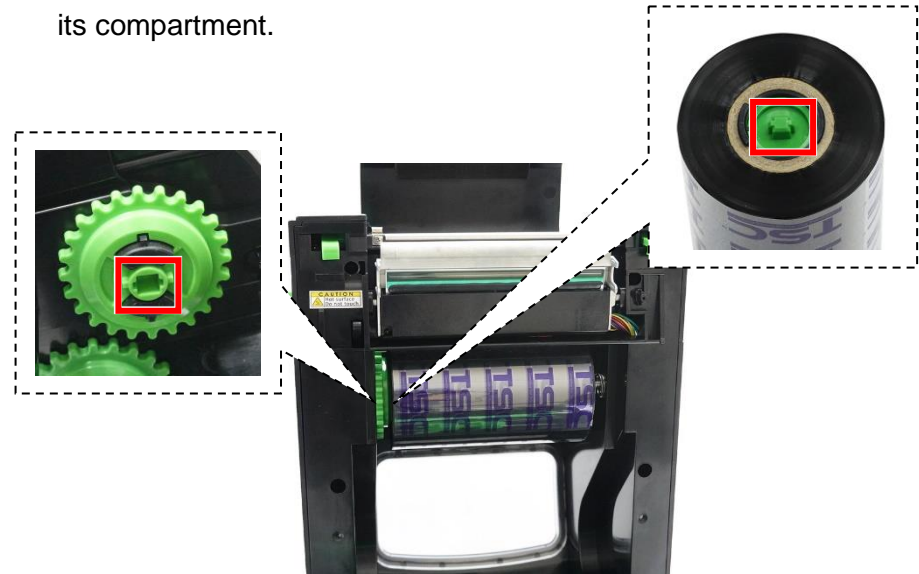

7. Pull upward the adhesive strip on front side of the ribbon roll.



8. Carefully adhere the adhesive strip on the rewind paper core.

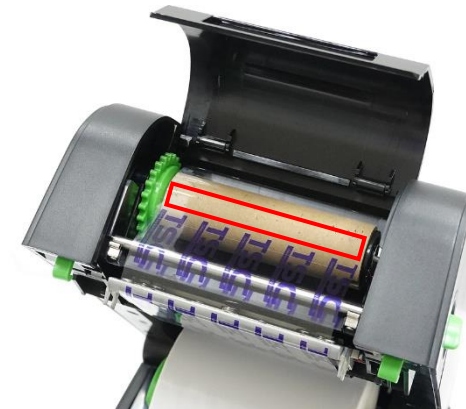

9. Rotate the gear in the indicated direction until the ribbon completely covers the printhead.



10. Keep rotating the mentioned gear until the ribbon completely covers the printhead and remove any wrinkle from the ribbon.

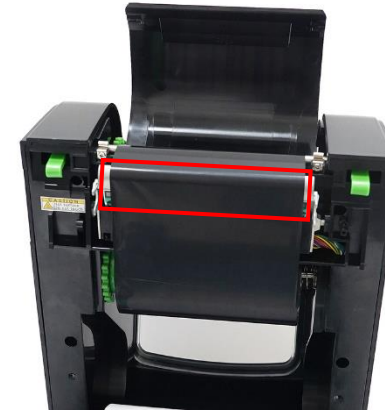

11. Close the ribbon access cover and top cover.

NOTE: The illustration below describes the ribbon path and media path for the TH240 series printers.

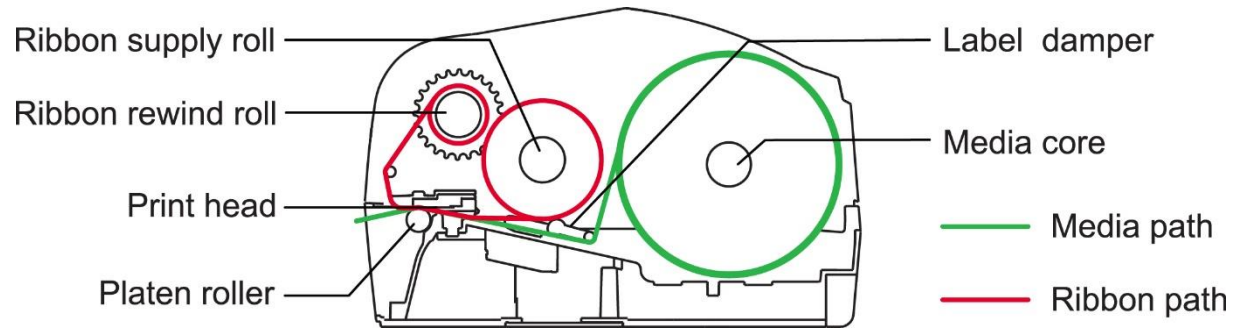

4.4 Loading the Media in Peel-off Mode (Optional)

1. Install the media and perform a media calibration for the media in use. For information about how to install the media and perform the calibration, please refer to 4.2 Loading the Media and 7.2 Sensor.
2. Open the printer's top cover.
3. Pull the media until it extends the platen roller.
4. Open the peel roller.



5. Remove some pieces of label from the release liner.



6. Thread the media through the opening on the peel module.

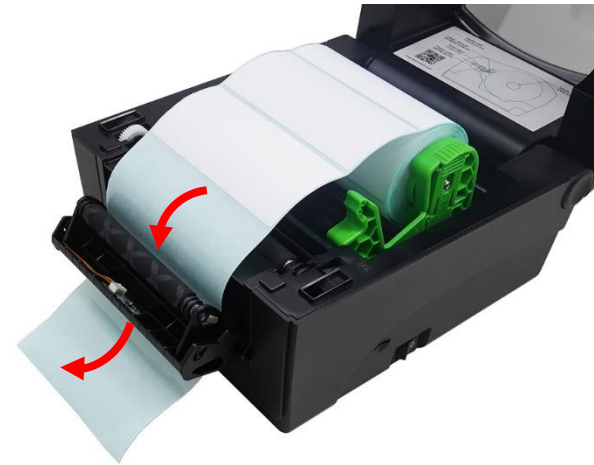

7. Close the peel roller.



8. Close the printer's top cover. Set the print mode to Peeler Mode and then print a label to check if the peel module works well. For how to set the print mode to Peeler Mode, please refer to 6.7 Configuring Optional Kits and 7.1.1 TSPL.



4.5 Loading the Media in Cutter Mode (Optional)

1. Open the printer's top cover and then load the media. For how to open the printer's top cover and load the media, please refer to 4.2 Loading the Media.
2. Push the release latch as indicated to open the cutter gate.



3. Pull the media until it extends out of the cutter gate.



4. Close the cutter gate.



5. Close the printer's top cover.



6. Perform the media calibration for the media in use. For information about how to perform the media calibration, please refer to 7.2 Sensor.

7. Set the printer to the Cutter Mode. For information about how to set the printer to Cutter Mode, please refer to 6.7 Configuring Optional Kits and 7.1.1 TSPL.

8. Print a label to check if the cutter module works well.

5 Operator Interface

Two operator interface options are available on the printers: **LED User Interface** and **LCD User Interface**. In addition to the two physical user interfaces, you can also use **Web User Interface** to control and manage the printers.

5.1 LED User Interface

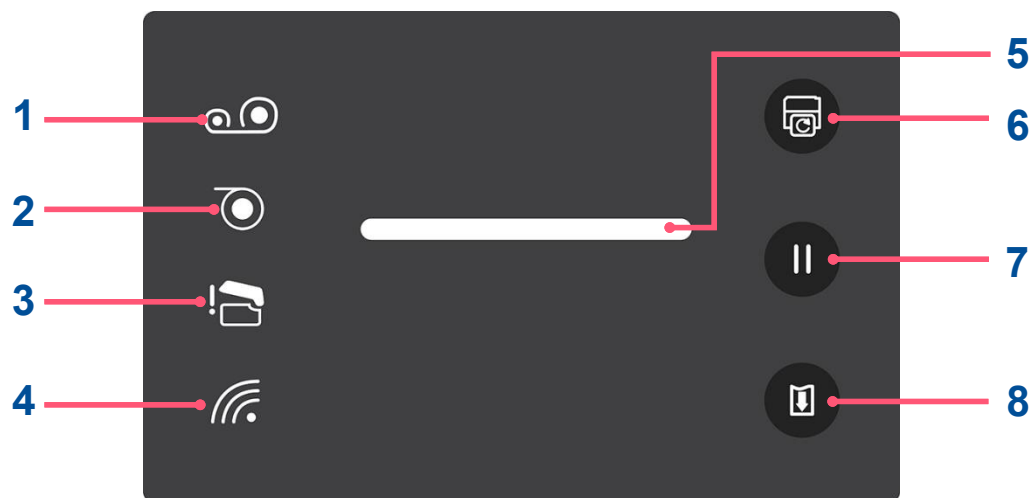

5.1.1 Control Panel



No.	Name	Description
1	Ribbon Out Indicator	Indicates the ribbon supply. ON: The ribbon is used up. Blinking: The ribbon roll is near the end.
2	Paper Out Indicator	Indicates the media supply. ON: The media is used up. Blinking: Paper is stuck in the printer.
3	Printhead Open Indicator	Indicates if the printhead is correctly closed. ON: The printhead is open.

No.	Name	Description
4	Wi-Fi Connection Indicator	Indicates the Wi-Fi connection status. ON: The wireless connection is active.
5	LED Indicator	Please refer to 5.1.2 LED Indicator for detailed information about the LED indicator and its behavior.
6	Reprint Button	Reprints the last label.
7	Pause Button	Stops the print activities. Press the button to resume the print activities.
8	Feed Button	Feeds one piece of media.

5.1.2 LED Indicator

Color		Description
	Green	ON: The printer is ready for accepting the print job. Blinking: The system is downloading data or the printer is in pause mode.
	Amber	The system is busy.
	Red	ON: The printer's top cover is open or cutter error. Blinking: Other errors, such as paper jam, paper empty, ribbon empty, memory error etc.

5.1.3 Power-on Utilities

LED User Interface features a set of utilities which provides quick access to the printer's mostly used functions.

Follow the procedures below to launch the power-on utilities and select the function you need.

1. Turn off the printer.
2. Press and hold **Feed** and then turn on the printer. Keep holding **Feed**. The LED indicator on the control panel will start blinking in a sequence of patterns that indicates which function is going to be activated.
3. When the LED indicator blinks in the pattern which indicates the function you need, release **Feed**. The Power-on Utilities will run the function you select.

The table below describes the sequence of the patterns and their corresponding functions.

LED Color & Pattern		Red (5 blinks)	Amber (5 blinks)	Green (5 blinks)	Green & Amber (5 blinks)	Red & Amber (5 blinks)	Green (ON)
Sequence & Function							
1	Sensor Calibration (Gap / Black Mark Sensor)	release					
2	Self-Test (Enters Dump Mode)		release				
3	Factory Default			release			
4	Black Mark Calibration				release		
5	Gap Calibration					release	
6	Ready (Skips AUTO.BAS)						release

LED User Interface also provides two shortcuts to the **Factory Default** and **Sensor Calibration** function respectively.

To run **Factory Default**:

1. Turn off the printer.
2. Press and hold **Feed + Pause** and then turn on the printer. When the printer beeps twice, release the two buttons. All printer's configurations will be reset to factory default.

To run **Sensor Calibration**:

1. Turn off the printer.
2. Press and hold **Pause** and then turn on the printer. When the printer beeps twice, release **Pause**. The printer will automatically start calibrating sensor.

5.2 LCD User Interface

5.2.1 LCD Panel

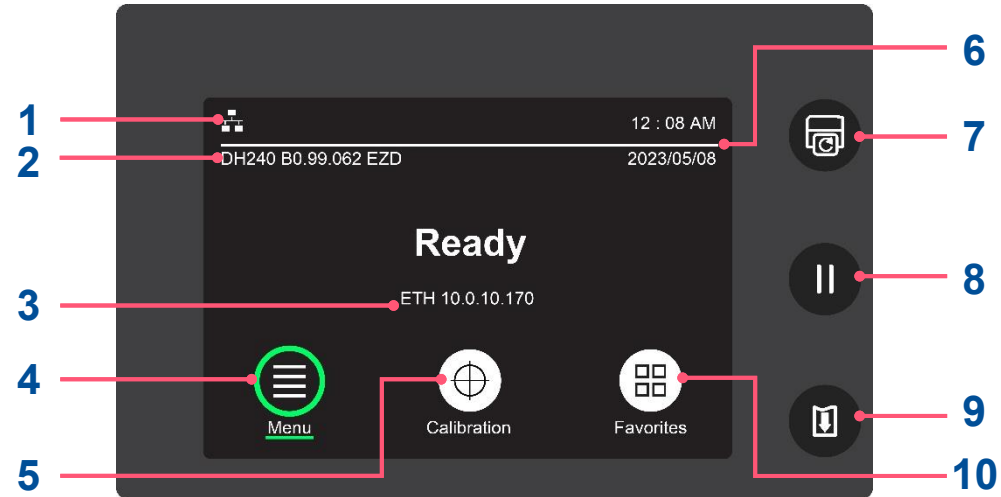

No.	Name	Description
1	Icon Indicators Area	Displays icons to indicate the printer's status. Refer to 5.2.3 Icon Indicators for more information.
2	Model Name & Firmware	Displays the printer's model name and firmware version.
3	Ethernet & Wi-Fi Address	Displays the Ethernet or Wi-Fi IP address when connecting to the Ethernet or Wi-Fi network.
4	Menu	Includes more setting options. Refer to 7 Main Screen for more information.
5	Calibration	Calibrates the printer based on what kind of media you want to use. Refer to Auto Calibration in 7.2 Sensor for more information.
6	Date & Time	Displays the date and time. Refer to 7.4 Advanced for how to configure the date and time for the printer.
7	Reprint Button	Reprints the last label.
8	Pause Button	Stops the print activities. Press the button to resume the print activities.
9	Feed Button	Feeds one piece of media.
10	Favorites	Adds and removes your mostly used functions into the favorites list. Refer to 7.7 Favorites for how to add and remove your mostly used functions into the favorites list.



5.2.2 Power-on Utilities

LCD User Interface features a set of utilities which provides quick access to the printer's mostly used functions. Follow the procedures below to launch the power-on utilities and select the function you want to use.

1. Turn off the printer.
2. Press and hold **Feed** and then turn on the printer. Keep holding **Feed**. The display will start playing a series of images in the following sequence that indicates which function is going to be activated.
3. When the image that indicates the function you need appears on the display, release **Feed**. The Power-on Utilities will run the function you select.

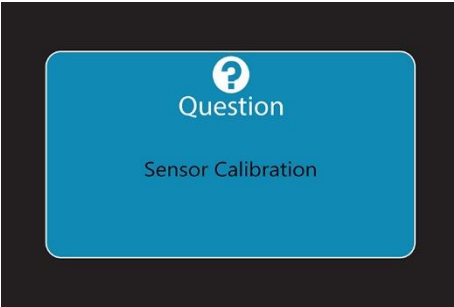
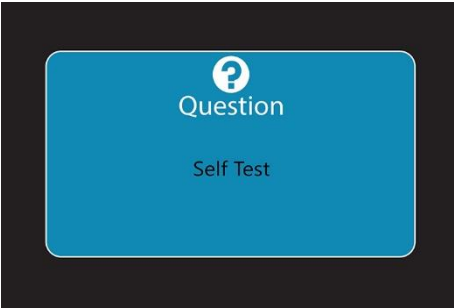

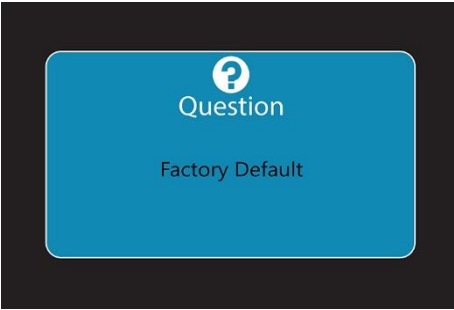

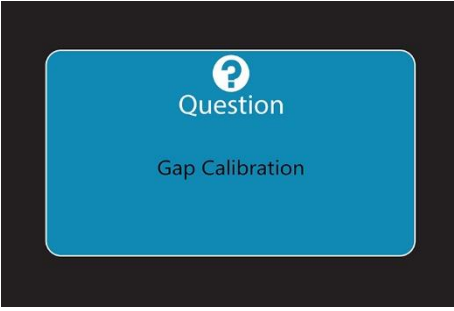
The table below describes the sequence of the images and their corresponding functions.

Sequence & Function		Image
1	Sensor Calibration (Gap / Black Mark Sensor)	
2	Self Test (Enters Dump Mode)	

Sequence & Function		Image
3	Factory Default	 <p>A screenshot of a blue dialog box with rounded corners, centered on a black background. At the top, there is a white question mark icon inside a circle, followed by the word 'Question' in white. Below that, the text 'Factory Default' is displayed in white.</p>
4	Black Mark Calibration	 <p>A screenshot of a blue dialog box with rounded corners, centered on a black background. At the top, there is a white question mark icon inside a circle, followed by the word 'Question' in white. Below that, the text 'Bline Calibration' is displayed in white.</p>
5	Gap Calibration	 <p>A screenshot of a blue dialog box with rounded corners, centered on a black background. At the top, there is a white question mark icon inside a circle, followed by the word 'Question' in white. Below that, the text 'Gap Calibration' is displayed in white.</p>
6	Ready (Skips AUTO.BAS)	Main screen will appear on the display if users do not select any of the abovementioned functions.

5.2.3 Icon Indicators

NOTE: Icon indicators only apply for models shipped with **LCD User Interface**.

Icon	Description
	Indicates that the printer is connected to the wireless network.
	Indicates that the printer is connected to the Ethernet network.
	Indicates that the printer is paired with an external device via Bluetooth or the printer is receiving data via Bluetooth.
	Indicates the remaining amount of the ribbon roll.
	Indicates that the printhead needs maintenance.

5.3 Web User Interface

Web User Interface enables users to control and manage one or several printers using a remote device over network.

5.3.1 Opening the Web User Interface

Follow the steps below to open the web user interface for the printer:

1. Open your web browser.
2. Enter the printer's IP address inside the browser's address bar and then press "Enter".

NOTE: For how to know the printer's IP address, you may refer to 6 TSC Console for detailed information or contact your IT department for further assistance.

NOTE:

- ♦ **Due to regional regulations, when logging in for the first time in specific areas, users will be prompted to set a new username and password. The screen prompting you to set a new username and password will appear on the display when you log in for the first time.**

Please enter the username of administrator "admin", and its default password "admin".

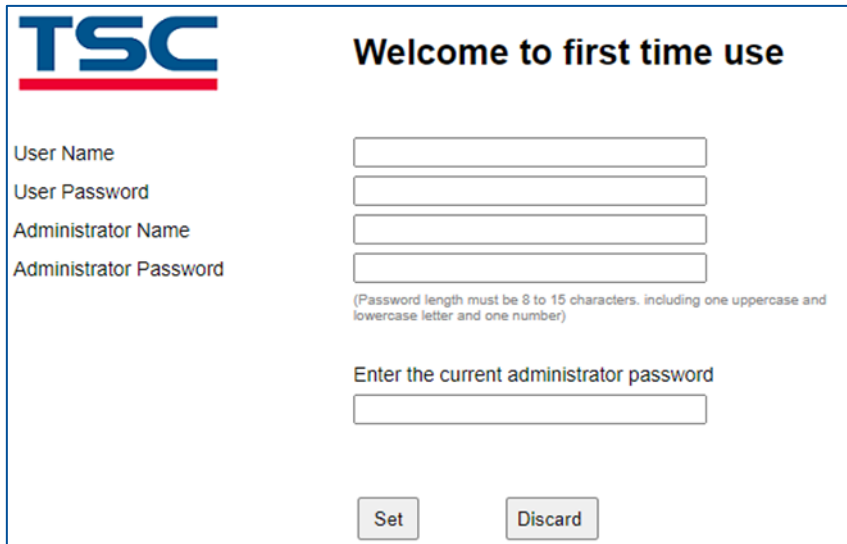

The screenshot shows the TSC printer's web user interface. At the top left is the TSC logo. To its right is the heading "Welcome to first time use". Below this, there are four input fields: "User Name", "User Password", "Administrator Name", and "Administrator Password". A note below the Administrator Password field states: "(Password length must be 8 to 15 characters, including one uppercase and lowercase letter and one number)". Below these fields is a label "Enter the current administrator password" followed by another input field. At the bottom of the form are two buttons: "Set" and "Discard".

- ◆ The password setting rules are as follows: the length is limited to 8 to 15 characters, it must contain at least one uppercase and lowercase letter and a number. The content can be English letters, numbers, or symbols, but does not support double-byte characters.
- ◆ To consider security, the printer will restart if you enter an incorrect password 5 times.

3. When the screen appears, you can start using the web user interface to manage the printer.

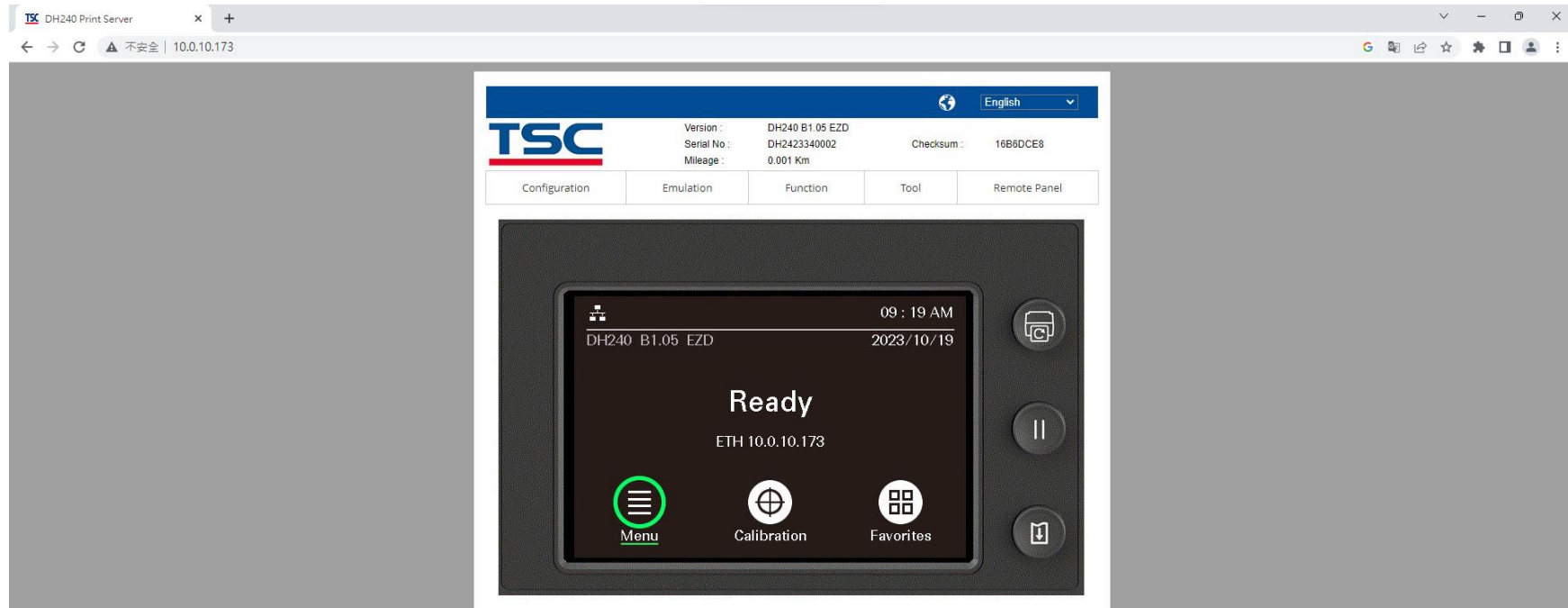

5.3.2 Introduction to Web User Interface

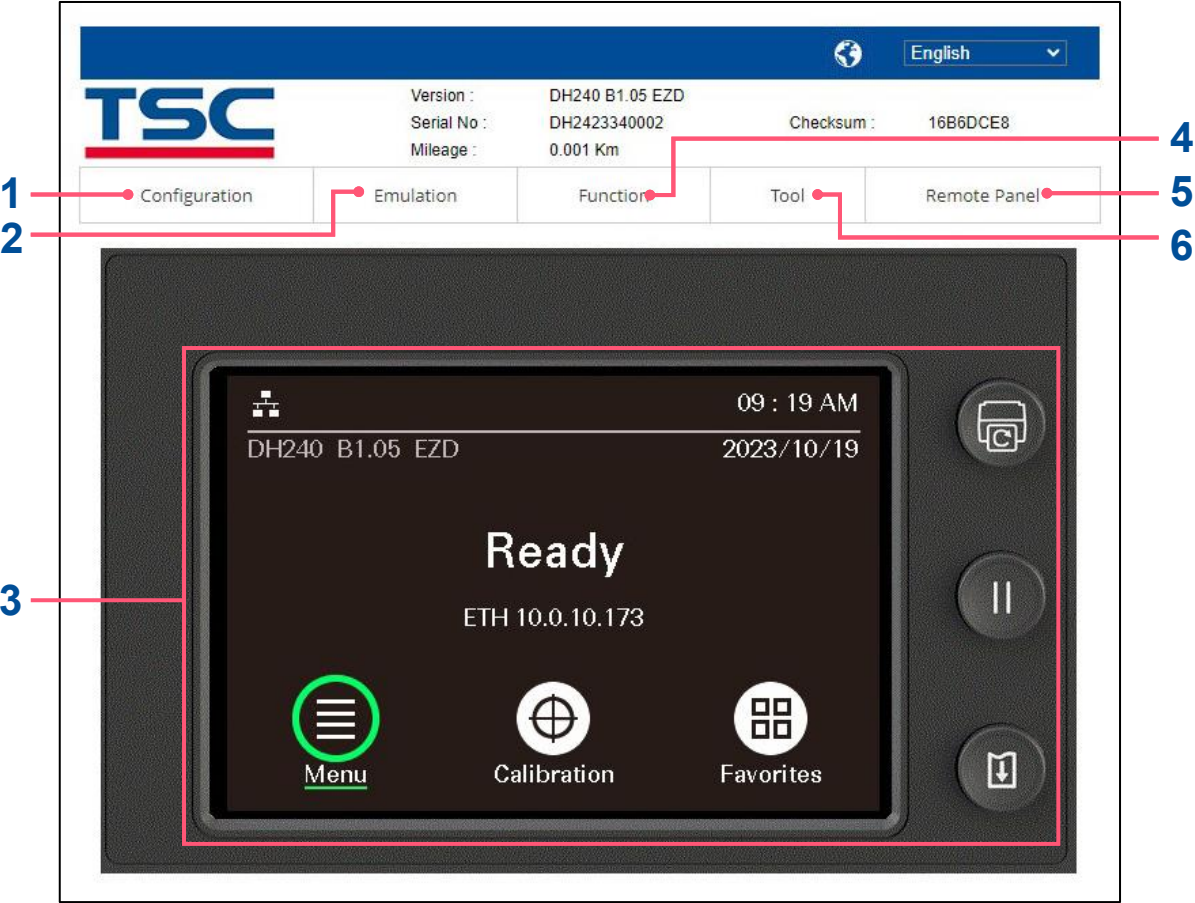

No.	Description	No.	Description
1	Refer to 5.3.2.1 Configuration for more information.	4	Refer to 5.3.2.3 Function for further information.
2	Refer to 5.3.2.2 Emulation for more information.	5	Opens the visualized control panel. Refer to 5.3.2.4 Visualized Control Interface for further information.
3	Refer to 5.3.2.4 Visualized Control Interface for more information.	6	Refer to 5.3.2.6 Tool for further information.

5.3.2.1 Configuration

Item		Description
Print	Common	Configures the printer using the TSPL command set. Refer to 7.1.1 TSPL for more information.
	Adjust	Adjusts the print and stop location. Refer to 7.1.1 TSPL for more information.
	Media	Configures the parameters that relate to the media type and sets the media sensor. NOTE: For DH240 series, when using the upper black mark sensor, you must shift the bottom black mark sensor to the left or right side of the printer to prevent interference and obtain better calibration result.
	Calibration	Configures the parameters that affect the media calibration.
RS232		Configures the settings for RS-232.
Bluetooth		Configures the settings for Bluetooth.
Ethernet		Configures the settings for Ethernet.
802.1X		Sets the 802.1X authentication.
Wi-Fi		Configures the settings for Wi-Fi.
Raw Port Filter		Configures the settings for RAW port filter.
RTC Setup		Sets the date and time for the printer.

5.3.2.2 Emulation

Item	Description
Z	Emulates Zebra printer language and allows users to configure the printer.
D	Emulates Datamax printer language and allows users to configure the printer.

5.3.2.3 Function

Item	Description
SOTI settings	Sets the MQTT server and manages the CA certificate files.
TPH Care	Monitors the printhead's health status.
Email	Sets the SMTP server.
SNTP	Sets the SNTP server.
SNMP	Configures the SNMP (Simple Network Management Protocol) for the printer.
Web Password	Sets the user/administrator name and its corresponding password.
Log	Records the printer's activities.
Function	Provides quick access to the following functions: <ul style="list-style-type: none">• Reset Printer• Configuration Page• Sensor Calibration• Factory Default• Ignore AUTO.BAS• Preferred Wi-Fi / Preferred Ethernet• Send File to Printer

5.3.2.4 Visualized Control Interface

The visualized control panel demonstrates the same user interface as the models shipped with an LCD display panel. This feature is also applicable to the models that do not feature an LCD display panel. For how to use the buttons and setting options on the control panel, you can refer to 5.2.1 LCD Panel.

5.3.2.5 Remote Panel

It allows users to open the visualized control panel. Refer to 5.3.2.4 Visualized Control Interface for more information.

5.3.2.6 Tool

Item	Description
File Manager	Manages the files saved in the built-in memory.
Communication Tool	Sends command sets or instructions to the printer.
Update Firmware	Updates the printer's firmware.
Clear Browsing Record	Clears the browsing record.
Classic Webpage	Switches to the classic user interface.

6 TSC Console

Designed especially for the TSC printers, **TSC Console** enables users to deploy, manage, monitor, and troubleshoot both wired or wireless connections to one or a group of printers. **TSC Console** lowers IT costs and increases printer uptime with convenient out-of-the-box installation and a simplified Windows graphical user interface. It enhances robustness through integrated management capabilities and ensures that printers are available, reliable, and serviceable at all times.

6.1 Launching TSC Console

Follow the steps below to launch **TSC Console**:

1. Double click the **TSC Console** icon on the desktop of your computer to launch **TSC Console**. After launching **TSC Console**, the following screen will appear.

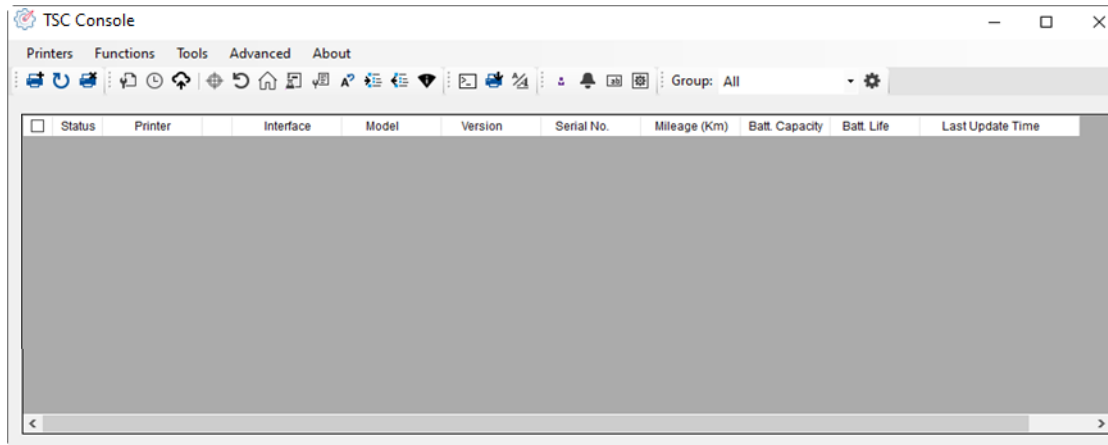

2. Select **Printers > Add Printers** to add the new printer to the **TSC Console** main page.

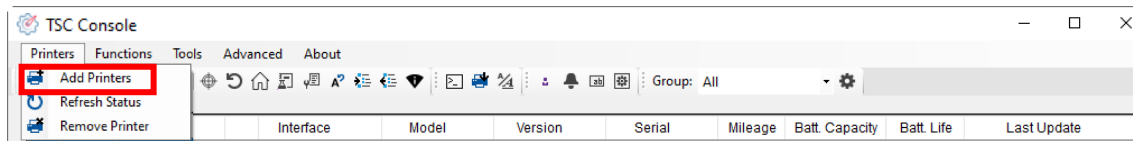

3. Select the connection based on how the printer is connected to your computer and then select **OK** to add the printer.
NOTE: The image below shows that the printer is connected to a computer via the USB cable.

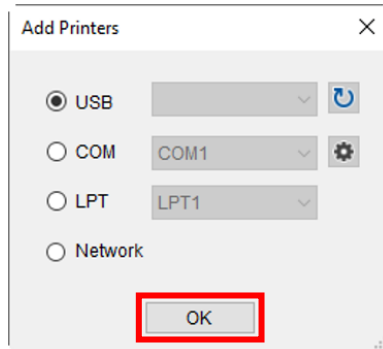

4. Select and start configuring the printer.

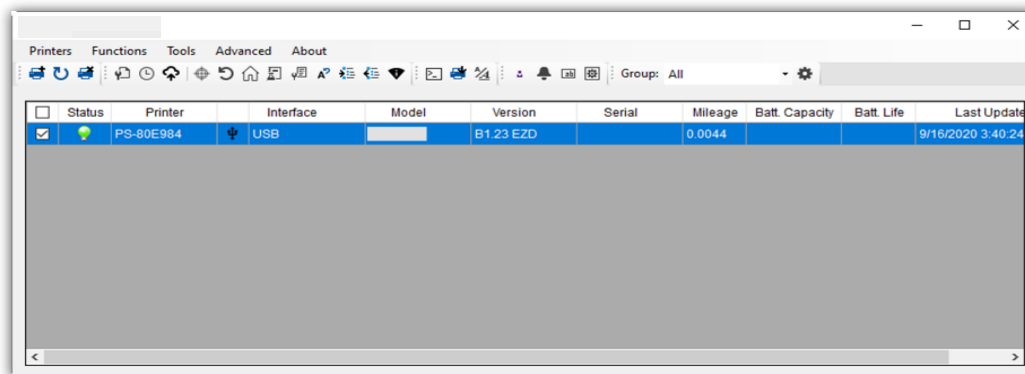

NOTE: You may refer to **TSC Console Programming Manual** for further information.

6.2 Adding Ethernet Interface

It allows users to add Ethernet interface to the **TSC Console** main page and enables users to control the printer through a wired network.

Follow the steps below to add Ethernet interface to the **TSC Console** main page:

1. Add the printer to the **TSC Console** main page via the USB port or COM port. For how to add the printer to the **TSC Console** main page, please refer to 6.1 Launching TSC Console.

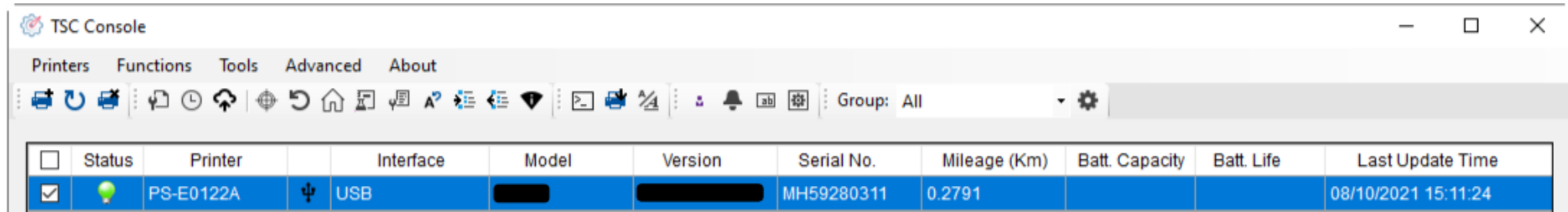

The screenshot shows the TSC Console application window. The title bar reads "TSC Console". Below the title bar are menu items: "Printers", "Functions", "Tools", "Advanced", and "About". A toolbar contains various icons for printer management. Below the toolbar is a table with the following data:

<input type="checkbox"/>	Status	Printer	Interface	Model	Version	Serial No.	Mileage (Km)	Batt. Capacity	Batt. Life	Last Update Time
<input checked="" type="checkbox"/>		PS-E0122A	USB			MH59280311	0.2791			08/10/2021 15:11:24

2. Double click the printer you want to configure. When the **Printer Configuration** page appear, select the **Ethernet** tab. Write down the printer's IP address which is required to add the Ethernet interface.

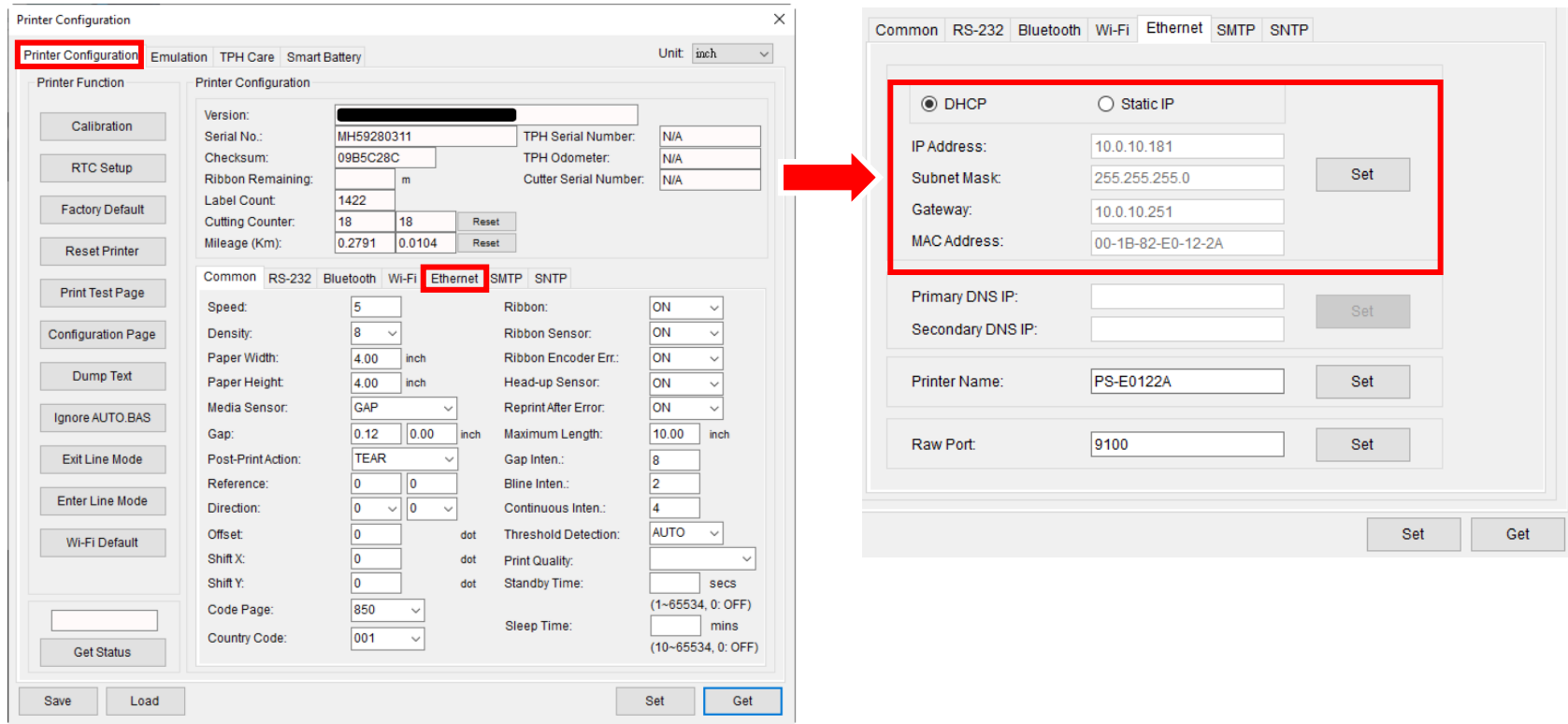

3. Go to the **TSC Console** main page. Select **Printers > Add Printers**.

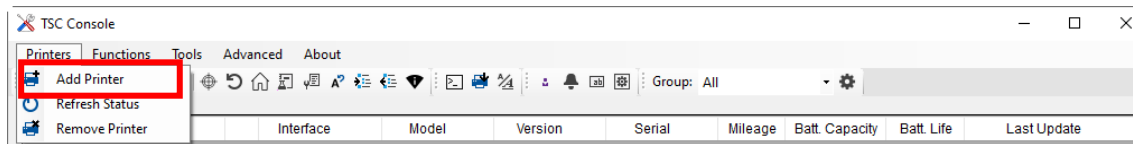

4. Select **Network** and then select **OK**. Enter the printer's IP address you have just written down in the **IP Address** field and then select **Discover**.

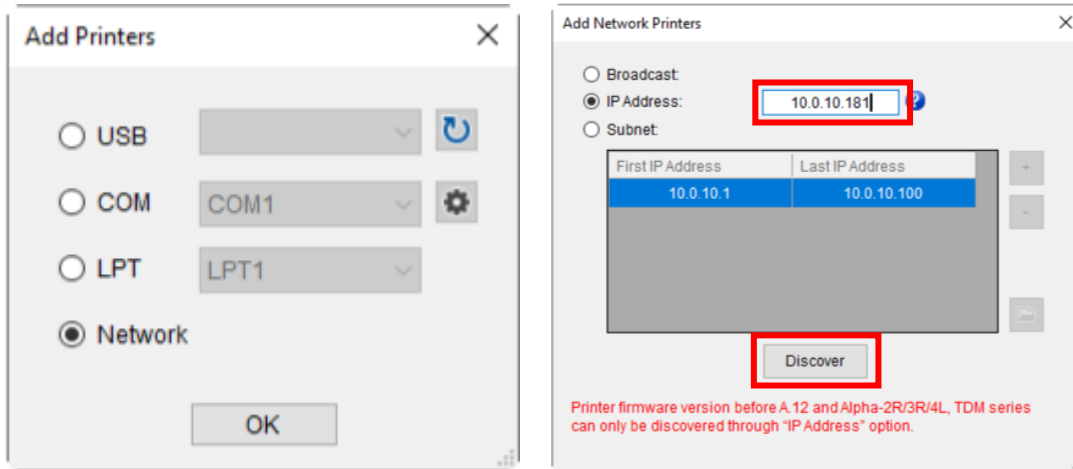

5. When the message prompts to inform that the corresponding printer is found, select **OK** to finish the configuration. You can find the Ethernet interface is displayed on the **TSC Console** main page.

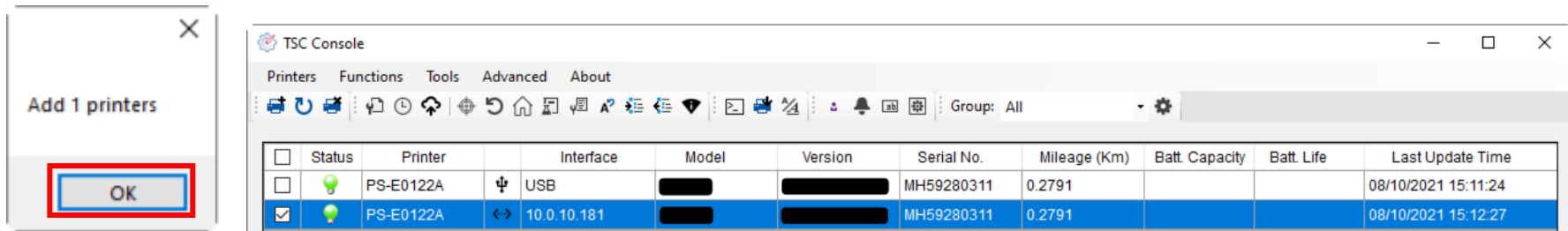

6.3 Adding Wi-Fi Interface

It allows users to add Wi-Fi interface to the **TSC Console** main page and enables users to control the printer through a wireless network. Follow the steps below to add Wi-Fi interface to the **TSC Console** main page:

1. Add the printer to the **TSC Console** main page via the USB port or COM port. For how to add the printer to the **TSC Console** main page, please refer to Launching TSC Console.
2. Double click the printer you want to configure to open the **Printer Configuration** page.

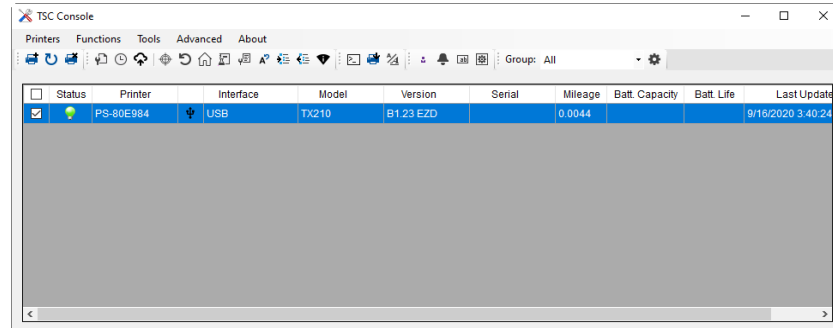

3. When the **Printer Configuration** page appear, select **Get** to retrieve the printer's information.
4. Select the **Wi-Fi** tab to open the configuration menu for Wi-Fi.

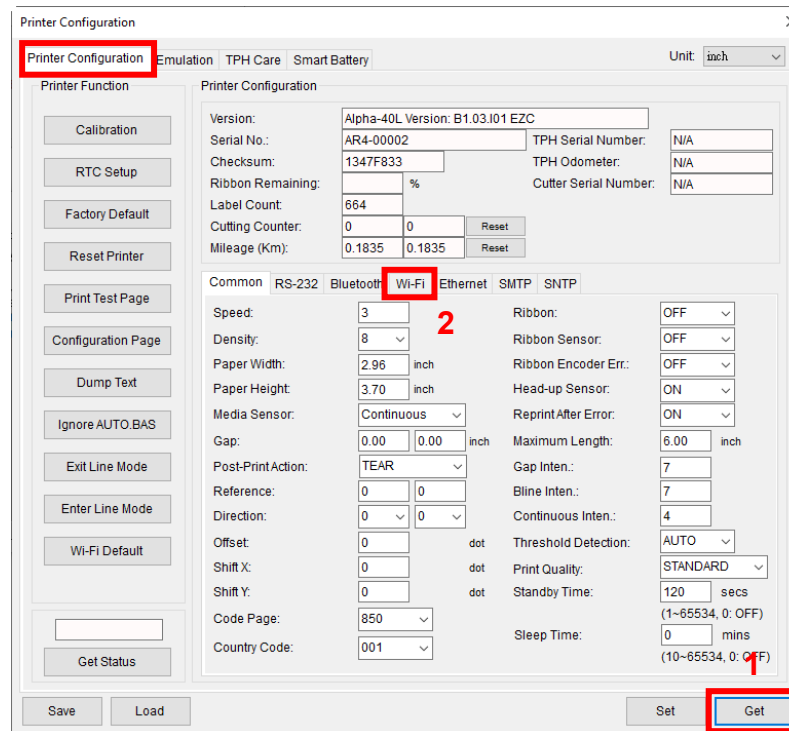

When using the WPA-Personal encryption:

- (1) Enter the network name in the **SSID** field.
- (2) Select **WPA-Personal** in the **WLAN Encryption** field.
- (3) Enter the Wi-Fi network password in the **Key** field.
- (4) Set **DHCP** to **ON**. If **DHCP** is set to **OFF**, you need to specify information for the **IP Address**, **Subnet Mask**, and **Gateway** fields.
- (5) Select **Set** to finish the configuration.

NOTE: The fields marked in yellow indicate that information in the fields have been changed before selecting **Set** to finish the configuration.

NOTE: Users are also allowed to change the name for the printer and raw port in the **Printer Name** field and **Raw Port** field.

Common RS-232 Bluetooth Wi-Fi Ethernet SMTP SNMP

Built-in Wi-Fi Module

SSID: SSID_1

WLAN Encryption: WPA-Personal

Key: *****

DHCP: ON 1

IP Address:

Subnet Mask: 0.0.0.0

Gateway:

Primary DNS IP:

Secondary DNS IP:

Raw Port: 9100

Printer Name: PS-FF153C

MAC Address: 00:1B:82:FF:15:3C

EAP Type: [v]

Username:

Password:

File Name Browse

CA Certificate: [] []

Client Certificate: [] []

Private Key: [] []

EAP-FAST PAC: [] []

Wi-Fi Version: 3.7.1.0R6

RSSI: 0

Set Get

When using the WPA-Enterprise encryption:

- (1) Enter the network name in the **SSID** field.
- (2) Select **WPA-Enterprise** in the **WLAN Encryption** field.
- (3) Set **DHCP** to **ON**. If **DHCP** is set to **OFF**, you need to specify information for the **IP Address**, **Subnet Mask**, and **Gateway** fields.
- (4) Select EAP type in the **EAP Type** field.
- (5) Upload certificate and key for the **CA Certificate**, **Client Certificate**, and **Private Key** field respectively.
- (6) Select **Set** to finish the configuration.

NOTE: The fields marked in yellow indicate that information in the fields have been changed before selecting **Set** to finish the configuration.

NOTE: Users are also allowed to change the name for the printer and raw port in the **Printer Name** field and **Raw Port** field.

Common RS-232 Bluetooth Wi-Fi Ethernet SMTP SNMP

Built-in Wi-Fi Module

SSID: SSID_2

WLAN Encryption: WPA-Enterprise

Key: *****

DHCP: ON 1

IP Address:

Subnet Mask: 0.0.0.0

Gateway:

Primary DNS IP:

Secondary DNS IP:

Raw Port: 9100

Printer Name: PS-FF153C

MAC Address: 00:1B:82:FF:15:3C

EAP Type: [v] 2

Username:

Password:

File Name Browse

CA Certificate: [] []

Client Certificate: [] []

Private Key: [] []

EAP-FAST PAC: [] []

Wi-Fi Version: 3.7.1.0R6

RSSI: 0

3 Set Get

5. After selecting **Set** to finish the configuration, the message will appear on the screen and the printer will re-start automatically.

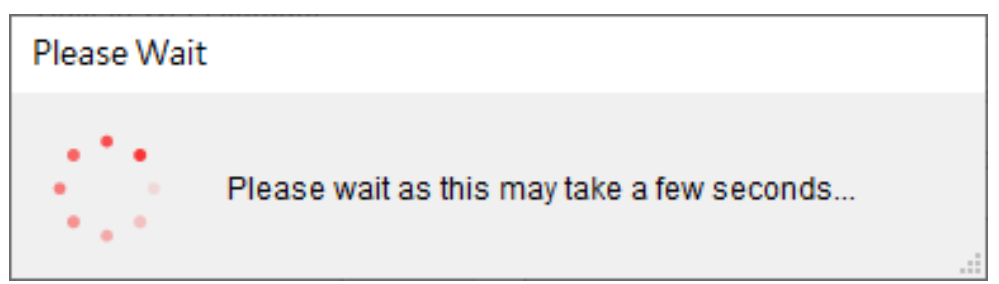

6. After the printer re-starts, the printer's IP address, the Wi-Fi icon, and the Wi-Fi's address will appear on the printer's display.

NOTE: The printer's IP address should appear on the printer's display in from 5 to 15 seconds after the printer re-starts. If the IP address does not appear, follow the steps described in [6.4 Initializing Printer's Wi-Fi Settings](#) to restore the Wi-Fi settings to factory default values and then re-configure the Wi-Fi connection.

7. Remove the interface cable.

8. Go to the **TSC Console** main page, select **Printers > Add Printers** and then select **Network** to add the printer.

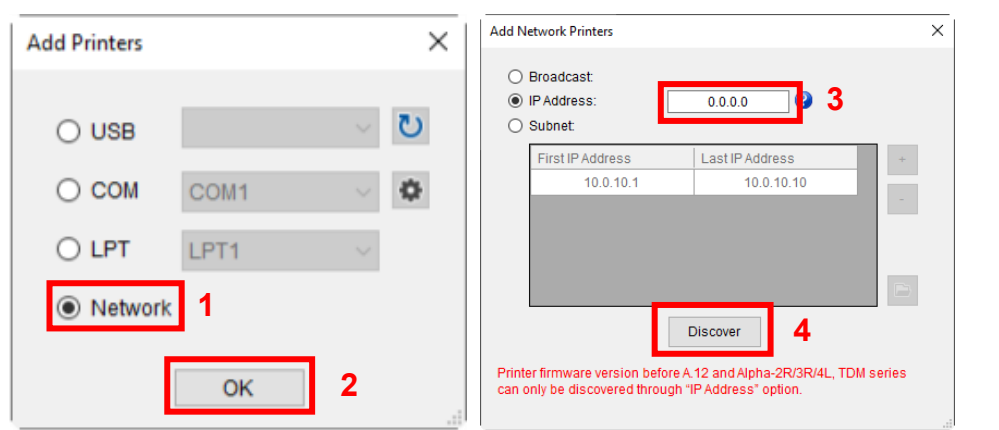

9. Go to the **TSC Console** main page.
10. Select **Functions > Print Test Page** to check if you can control the printer via the Wi-Fi connection.

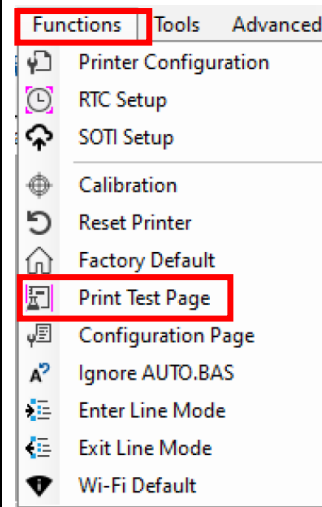

6.4 Initializing Printer's Wi-Fi Settings

- 1. Go to the **TSC Console** main page.
- 2. Select the **Functions** tab.

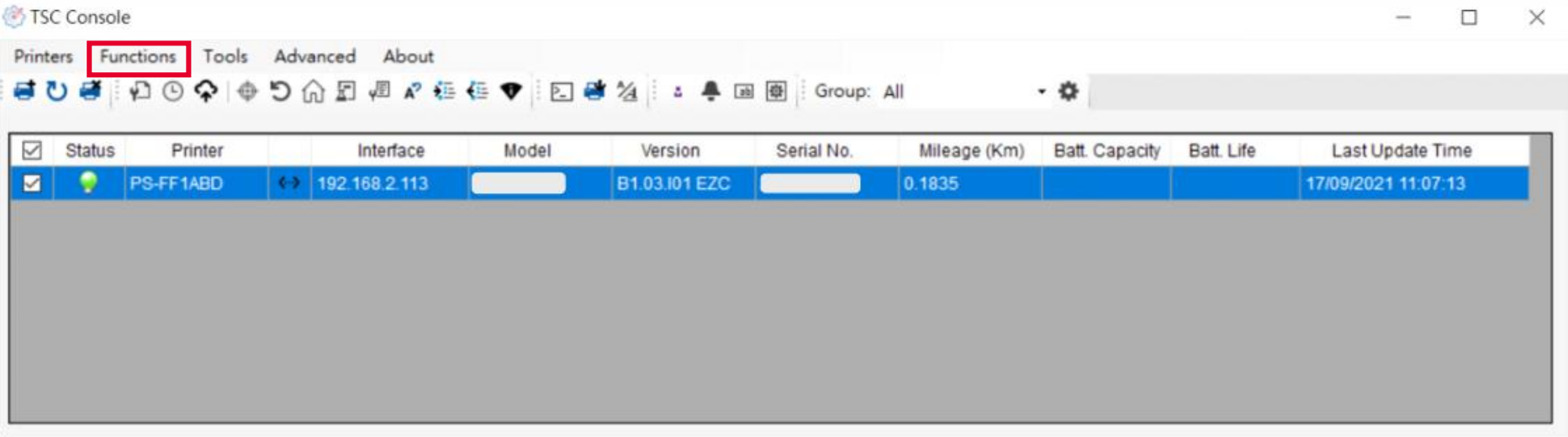

- 3. Select **Wi-Fi Default** to restore the Wi-Fi settings to factory default values.

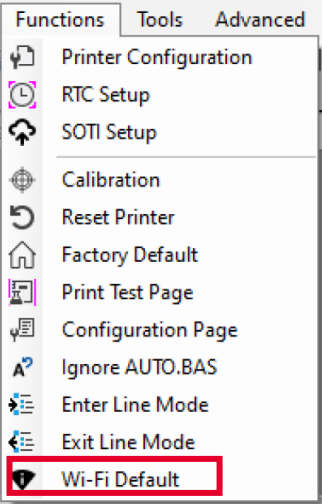

6.5 TPH Care

Self-Diagnostic TPH Care allows users to scan and detect defective dots on the printhead during the printing process. It helps reduce downtime, prevent faulty labels, and avoid barcodes of poor quality on mission critical tasks.

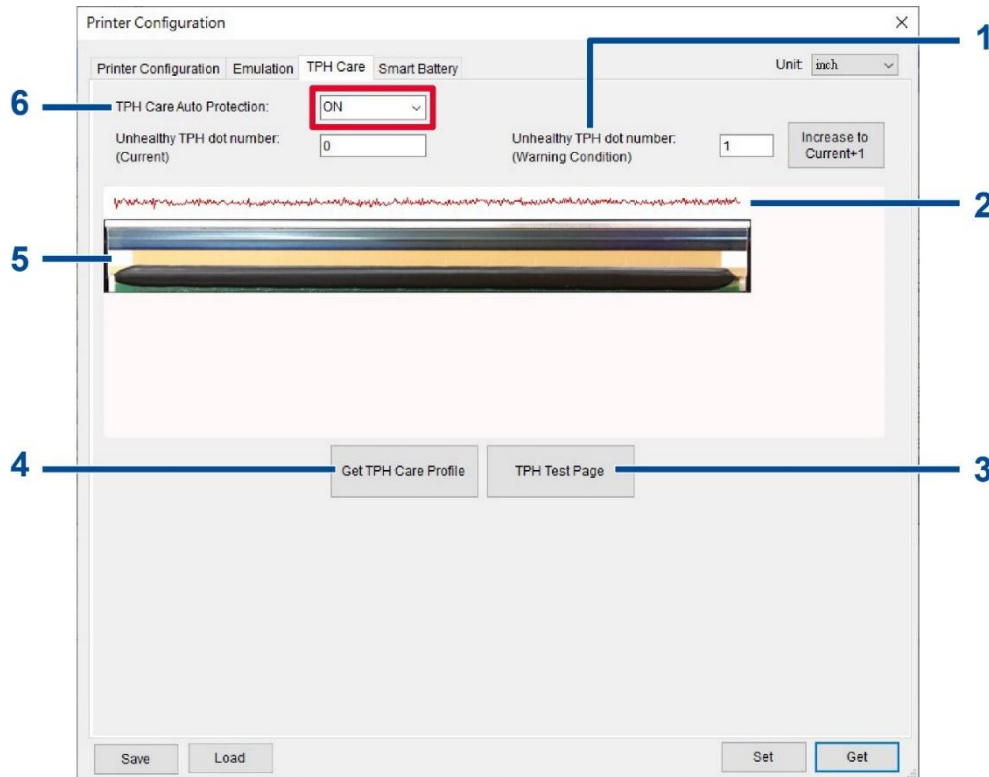

1. Sets the reminder that the defective dots have reached the configured numbers.
2. Shows the difference between the defective dots and the average of all other good dots in the series. The surge indicates that it is very likely that the dots in the corresponding area on the printhead are defective.
3. Prints the test page so that users can check the health status of the printhead.
4. Detects the defective dots on the printhead.
5. Allows users to check if there are defective dots on the printhead.
6. Enables/Disables **TPH Care Auto Protection**.

Follow the steps below to open the **TPH Care** page:

1. Double click the printer you want to configure on the **TSC Console** main page to open the **Printer Configuration** menu.

2. Select the **TPH Care** tab to enter the **TPH Care** page.

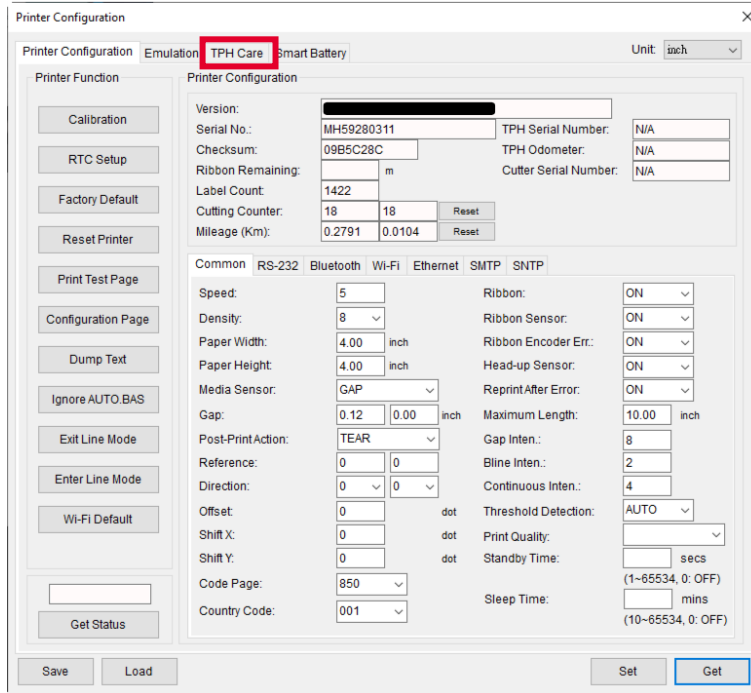

3. Enable the **TPH Care Auto Protection** function (Default: **OFF**).

4. Select **Get TPH Care Profile** to check the health status of the printhead.

If the pattern extends flat roughly, it means the status of the printhead is good. Alternatively, you can check the **Unhealthy TPH dot number** field. If the unhealthy dot number is 0, it means that the status of the printhead is good.

If surges or spikes appear as the following image, it is very likely that there are defective dots in the corresponding area on the printhead. The printer will stop printing.

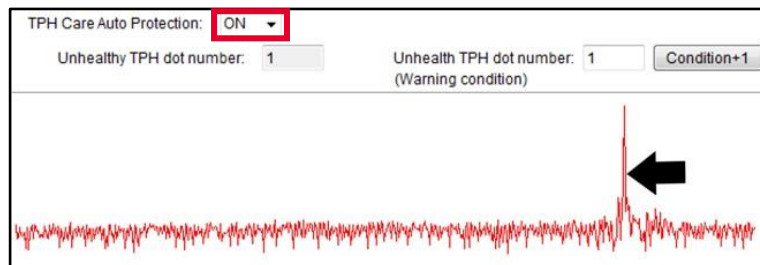

6.6 Printer's Main Functions

The function buttons are located on the left side of the **Printer Configuration** page. You can use the function buttons to manage and configure the printer.

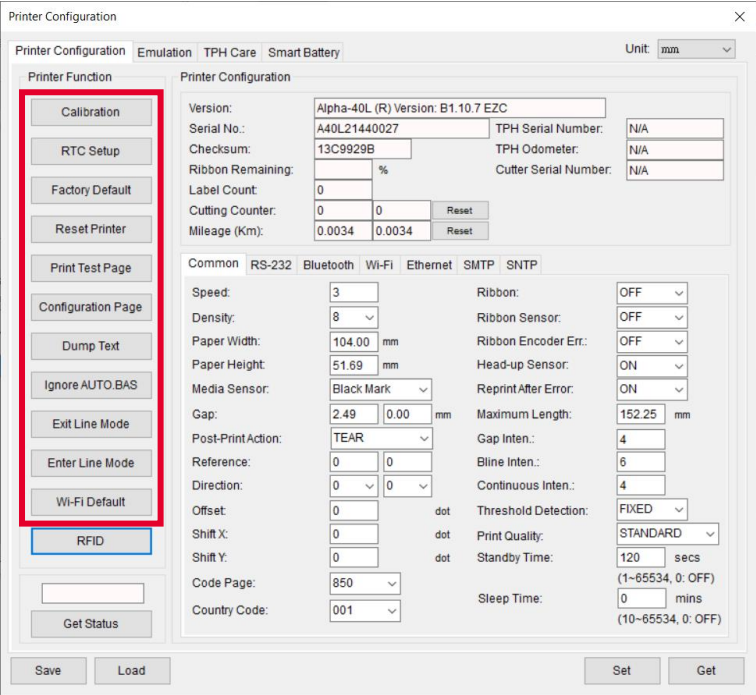

Item	Description
Calibration	Detects the media type and label size.
RTC Setup	Synchronizes the printer with the real time clock on the computer.
Factory Default	Restores the printer's settings to factory default values.
Reset Printer	Re-starts the printer.
Print Test Page	Prints test page based on the specified label size and sensor type.
Configuration Page	Prints the printer's configurations.
Dump Text	Activates Dump Mode.
Ignore AUTO BAS	Ignores the AUTO BAS file when the printer boots up.
Exit Line Mode	The printer will leave line mode and enter page mode.
Enter Line Mode	The printer will leave page mode and enter line mode.
Wi-Fi Default	Restores the Wi-Fi settings to factory default values.

6.7 Configuring Optional Kits

If you install an optional kit on the printer, such as cutter, peeler, or media rewinder, you need to configure the kit after finishing the calibration so that the kit works properly.

To configure the kit:





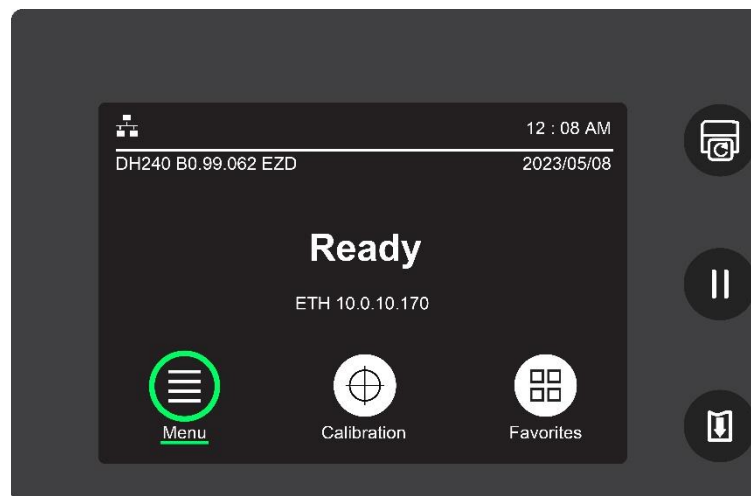

1. Add the printer to the **TSC Console** main page via the USB port or COM port. For how to add the printer to the **TSC Console** main page, please refer to 6.1 Launching TSC Console.
2. Set up the wired or wireless connection between the printer and your computer. For how to connect the printer to your computer via the wired or wireless network, please refer to Adding Ethernet Interface and Adding Wi-Fi Interface.
3. Double click the printer you want to configure on the **TSC Console** main page to enter the **Printer Configuration** page.
4. Select **Get** to get printer's information.
5. Select the **Common** tab.
6. In the drop-down list for the **Post-Print Action** field, select the corresponding item based on what kind of kit you have installed on the printer.
7. Select **Set** to finish the configuration.

The screenshot shows the 'Printer Configuration' window with the 'Common' tab selected. The interface includes a left sidebar with buttons for 'Calibration', 'RTC Setup', 'Factory Default', 'Reset Printer', 'Print Test Page', 'Configuration Page', 'Dump Text', 'Ignore AUTO.BAS', 'Exit Line Mode', 'Enter Line Mode', 'Wi-Fi Default', 'RFID', and 'Get Status'. The main area displays printer details such as Version (MB240), Serial No. (A1), Checksum (126ADDB1), and Mileage (0.1415). A red box highlights the 'Common' tab. Below it, a red box highlights the 'Post-Print Action' dropdown menu, which is open and shows options: OFF, TEAR, PEEL, CUTTER, REWIND, and APPLICATOR. The 'TEAR' option is selected. Other settings include Speed (2), Density (8), Paper Width (101.60 mm), Paper Height (101.60 mm), Media Sensor (Continuous), Gap (0.00 mm), and various sensor and sensor error settings. At the bottom, 'Save' and 'Load' buttons are visible, and a red box highlights the 'Set' and 'Get' buttons.

7 Main Screen

All setting options for the printer can be divided into 6 sub-menus based on function. It allows users to configure the printer without connecting the printer to a computer. To open the 6 sub-menus, tap the **Menu** icon on the LCD panel.



Icon	Name	Description	Icon	Name	Description
	Setting	Configures the printer using the TSPL or ZPL2 command set. Refer to 7.1 Setting for more information.		Advanced	Allows users to set the OSD language, reset the printer to factory default, set the date and time, etc. Refer to 7.4 Advanced for more information.
	Sensor	Calibrates the media sensor. Refer to 7.2 Sensor for more information.		File Manager	Manages the files saved in the built-in memory. Refer to 7.5 File Manager for more information.
	Interface	Sets the communication interfaces. Refer to 7.3 Interface for more information.		Diagnostic	Helps users to troubleshoot the problems. Refer to 7.6 Diagnostic for more information.

7.1 Setting

It allows users to configure the printer using the TSPL or ZPL2 command set.

NOTE: TSPL indicates TSC printer language and ZPL2 indicates an emulation of Zebra printer language.

To configure the printer:

1. Tap **Command Set** to select the command set you want to use.



2. Select the item you want to configure.

7.1.1 TSPL

The following illustration and table describe the TSPL command set.

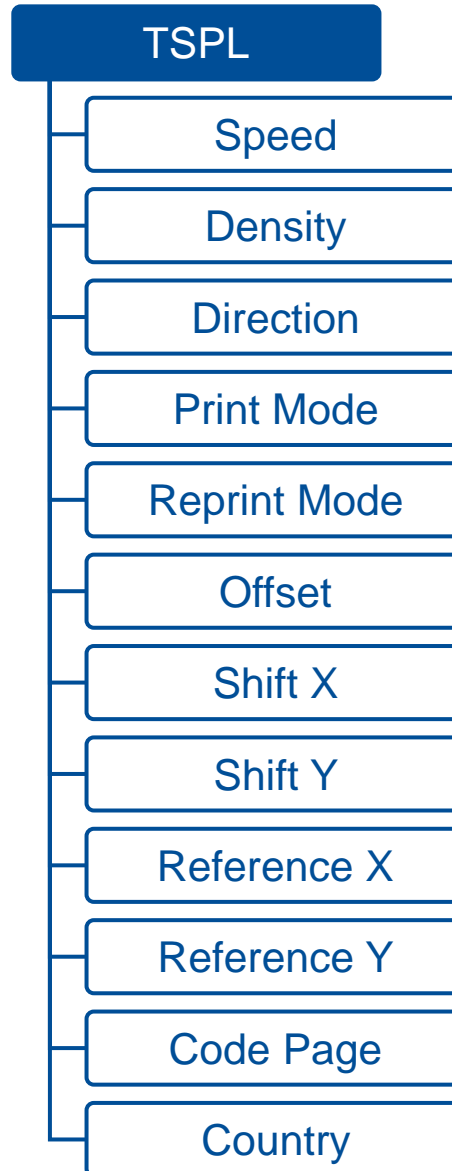

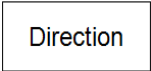
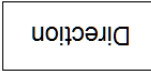
Item	Description	Default
Speed	Sets the print speed. Setting range: 1.5 to 8 ips (203 dpi), 1.5 to 6 ips (300 dpi).	5 (203 dpi) 4 (300 dpi)
Density	Sets the print darkness. Setting range: 0 to 15.	8
Direction	Sets the printout direction. Setting options: 0 or 1. When set to 0  When set to 1 	0
Print Mode	Sets the print mode. <ul style="list-style-type: none"> • Batch Mode: When printer finishes the print job, the label will be fed to a location where allows users to tear the label. • Cutter Batch: Sets the printer to cut the label when the print job is finished. • Cutter Mode: Enables the cutter mode. • Peeler Mode: Enables the peel-off mode. • None: TOF (Top of Form, the position the printer starts printing) for the next label is aligned with the printhead's burn line. 	Batch Mode
Reprint Mode	Enables/Disables Reprint Mode . When set to Enable , you can reprint the last label printed by pressing the Reprint button.	Enable
Offset	Specifies the stop position for each operation. Setting range: -203 to 203 dots.	0
Shift X	Specifies the amount to shift an image horizontally for precise print position on the label. Setting range: -203 to 203 dots.	0
Shift Y	Specifies the amount to shift an image vertically for precise print position on the label. Setting range: -203 to 203 dots.	0
Reference X	Specifies the x-coordinate relative to the origin. Setting range: 0 to 999 dots.	0
Reference Y	Specifies the y-coordinate relative to the origin. Setting range: 0 to 999 dots.	0

Item	Description	Default
Code Page	Specifies the code page which is associated with the supported characters.	850
Country	Sets the country code.	001

ATTENTION: If you print using a label design software or other label printing tools, the commands from the software or tool will overwrite the printer's settings you set through the LCD display panel.

7.1.2 ZPL2

The following illustration and table describe the ZPL2 command set.



Item	Description	Default
Darkness	Sets the print darkness. Setting range: 0 to 30.	16
Print Speed	Sets the print speed. Setting range: 1.5 to 8 ips (203 dpi), 1.5 to 6 ips (300 dpi).	5 (203 dpi) 4 (300 dpi)
Tear Off	Specifies the stop position of the media after a label is printed. Setting range: -120 to 120 dots.	0
Print Mode	<p>Sets the print mode.</p> <ul style="list-style-type: none"> • Tear Off: Allows users to tear off a label after it is printed. • Cutter: Enables the cutter mode. • Peel Off: Enables the peel-off mode. 	Tear Off
Print Width	Specifies the print width. Setting range: 2 to 864.	812
List Fonts	Prints the list of all linked fonts saved in the printer's memory.	
List Images	Prints the list of all linked images saved in the printer's memory.	
List Formats	Prints the list of all linked label formats saved in the printer's memory.	
List Setup	Prints the printer's configurations.	
Control Prefix	Sets the control command prefix.	7E (~)
Format Prefix	Sets the control format prefix.	5E (^)
Delimiter Char	Sets the delimiter character to separate the command parameters.	2C (,)
Media Power Up	<p>Configures the printer to take specific action after powering on the printer.</p> <ul style="list-style-type: none"> • No Motion: The printer will take no action. The sensor values and media position will not be changed. • Length: The printer will detect the length of a label and then advance the label to the correct position. • Calibration: The printer will run the calibration and then advance the media to the correct position according to the calibration results. • Feed: The printer will advance the label to the configured position. 	No Motion

Item	Description	Default
Head Close	Configures the printer to take specific action after closing the printhead. <ul style="list-style-type: none"> • No Motion: The printer will take no action. The sensor values and media position will not be changed. • Length: The printer will detect the length of a label and then advance the label to the correct position. • Calibration: The printer will run the calibration and then advance the media to the correct position according to the calibration results. • Feed: The printer will advance the label to the configured position. 	No Motion
Label Top	Specifies the amount to shift an image horizontally for precise print position on the label. Setting range: -120 to 120 dots.	0
Left Position	Specifies the amount to shift an image vertically for precise print position on the label. Setting range: -9999 to 9999.	0
Reprint Mode	When Reprint Mode is enabled, users can press  on the top cover of the printer to reprint the last label.	Enable
Format Convert	Selects the bitmap scaling factor. The first number indicates the original dpi (dots per inch) value while the second number indicates the dpi you want to scale. <ul style="list-style-type: none"> • None: No change • 300/600 • 200/600 • 150/600 • 150/300 	None

ATTENTION: If you print using a label design software or other label printing tools, the commands from the software or tool will overwrite the printer's settings you set through the LCD display panel.

7.2 Sensor

The setting options in the **Sensor** menu allows users to calibrate the printer based on what kind of the media they want to use. It is recommended to run the sensor calibration anytime you use a different media.

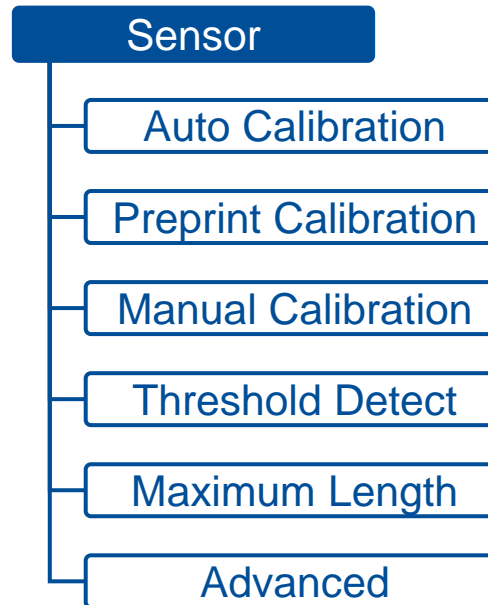

Item	Description	Default
Auto Calibration	Detects the media type and automatically runs the calibration. <ul style="list-style-type: none">• Gap• Black Mark• Continuous	
Preprint Calibration	Runs the calibration automatically when using the preprinted labels. <ul style="list-style-type: none">• Gap• Black Mark	

Item	Description	Default
Manual Calibration	<p>If Auto Calibration cannot determine the media type and complete the calibration, it is recommended to use Manual Calibration. After installing the media you want to use, follow the on-screen instructions to complete the calibration.</p> <ul style="list-style-type: none"> • Gap • Black Mark • Continuous 	
Threshold Detect	Sets the sensor's sensitivity. Setting options: Auto / Fixed.	Auto
Maximum Length	Specifies the maximum length for label calibration. Setting range: 1 to 9999 mm	253
Advanced	<p>Specifies the minimum label length and the maximum gap or black mark length before running Auto Calibration.</p> <ul style="list-style-type: none"> • Min. Paper (Setting range: 0 to 999 mm). • Max. Gap/Mark (Setting range: 0 to 999 mm). 	0

7.3 Interface

Interface menu allows users to configure the printer's I/O interfaces.

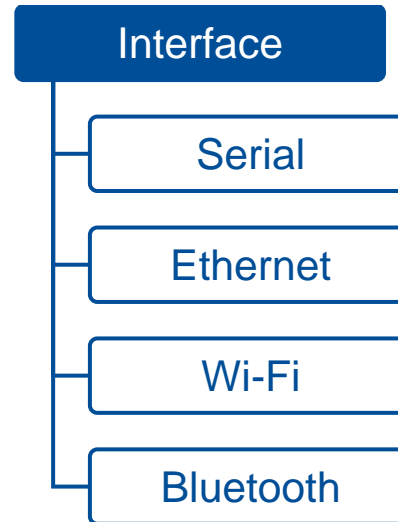

7.3.1 Serial

The table below describes the configurable items for the printer's RS-232 interface.

Item	Description	Default
Baud Rate	Sets Baud Rate for the RS-232 interface. Setting options: 1200 / 2400 / 4800 / 9600 / 19200 / 38400 / 57600 / 115200 bps.	9600
Parity	Sets parity check for the RS-232 interface. Setting options: None / Even / Odd.	None
Data Bits	Sets the number of bits in a data frame for the RS-232 interface. Setting options: 7 / 8.	8
Stop Bit	Sets the number of stop bits that mark the end of a frame for the RS-232 interface. Setting options: 1 / 2.	1

7.3.2 Ethernet

The table below describes the configurable items for the printer's Ethernet interface.

Item	Description	Default
Network Interface	Sets the network interface. Setting options: Ethernet / Wi-Fi.	
Status	Displays information about the Ethernet connection if the printer is connected to a wired network.	
Configure	Select to use a DHCP server or non-DHCP server. <ul style="list-style-type: none">• DHCP: Select to use a DHCP server.• Static IP: Select to use a non-DHCP server. You need to manually enter the IP address, subnet mask, and default gateway.	DHCP

7.3.3 Wi-Fi

The table below describes the configurable items for the printer's Wi-Fi connection.

Item	Description	Default
Network Interface	Sets the network interface. Setting options: Ethernet / Wi-Fi.	
Status	Displays information about the Wi-Fi connection if the printer is connected to a wireless network.	
Configure	Select to use a DHCP server or non-DHCP server. <ul style="list-style-type: none">• DHCP: Select to use a DHCP server.• Static IP: Select to use a non-DHCP server. You need to manually enter the IP address, subnet mask, and default gateway.	DHCP
SSID	Sets SSID for the Wi-Fi connection.	
Security	Sets security type for the Wi-Fi connection.	Open
Password	Sets a password for the Wi-Fi connection.	

7.3.4 Bluetooth

The table below describes the configurable items for the Bluetooth interface.

Item	Description	Default
Status	Displays information about the Bluetooth status.	
Local Name	Sets the local name for Bluetooth.	PS-XXXXXX NOTE: XXXXXX indicates the last six digits of the MAC address. You can find the MAC address in the Status item.
Pair Mode	Sets the pair mode for Bluetooth. <ul style="list-style-type: none">• LEGACY• JUSTWORK NOTE: This setting item is for MFi module only.	LEGACY
PIN Code	Sets the local pin code for Bluetooth. NOTE: This setting item is for MFi module only.	0000

7.4 Advanced

The illustration and table below describe the configurable items in the **Advanced** menu.

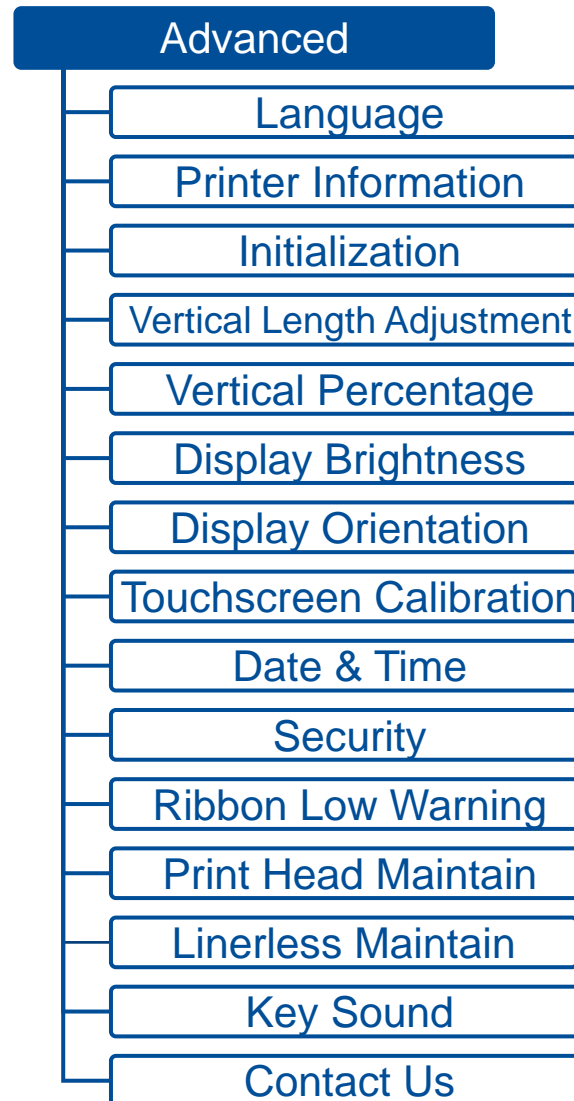

Item	Description	Default
Language	Changes the LCD menu language.	English
Printer Information	Displays printer's information, such as serial number, printhead mileage, the number of printed labels, etc.	
Initialization	Resets the printer to factory default.	
Vertical Length Adjustment	Turns on/off the Vertical Length Adjustment function.	OFF
Vertical Percentage	Adjusts the label length. Setting range: 90 to 115%.	100
Display Brightness	Adjusts the brightness for the display. Setting range: 0 to 100.	50
Display Orientation	Adjusts the orientation for the display. Setting options: 0 / 180.	0
Touchscreen Calibration	Performs the touchscreen calibration.	
Date & Time	Sets the date and time for the printer.	
Security	Sets a password to lock the access to the printer's settings. Default password: 8888.	Disable
Ribbon Low Warning	The printer will release the ribbon low warning message when the remaining ribbon length is less than the configured number of length. Setting range: 10 to 100 mm. NOTE: DH240 series printers do not feature this function.	30
Print Head Maintain	Sets how often the printhead should be cleaned. <ul style="list-style-type: none"> • Warning: Turns on/off the notification that reminds users to clean the printhead when the set amount of mileage is fulfilled. Default setting: Disable. • Reset Counter: Resets the mileage count after cleaning the printhead. • Interval: Sets mileage count for the printhead. When the set amount of mileage is fulfilled, the warning icon that reminds users to clean the printhead will appear on the display panel. Default setting: 1 km. 	

Item	Description	Default
Linerless Maintain	<p>Sets how often the linerless print module should be cleaned.</p> <ul style="list-style-type: none"> • Warning: Turns on/off the notification that reminds users to clean the linerless print module when the set amount of mileage is fulfilled. • Interval: Sets the cleaning schedules for the linerless print module. When the set amount of mileage is fulfilled, the warning icon () that reminds users to clean the cutter blade will appear on the display. (Default setting: 1 km) • Clean Cutter Blade: Lifts up to expose the cutter blade. Select this item to lift up the cutter blade if you need to clean the blade. NOTE: For how to clean the linerless cutter blade, please refer to Cleaning Procedures section for more information. CAUTION: To avoid the risk of personal injury, keep your hands away from the cutter gate when selecting Clean Cutter Blade. Selecting this item will lift up the blade. • Reset Counter: Resets the mileage count after cleaning the cutter blade. <p>NOTE: These options can also be quickly accessed directly from “Favorites” to set them up.</p>	
Key Sound	Turns on/off the sounds when tapping the touchscreen or pressing the function buttons.	ON
Contact Us	Displays the contact information about technical support.	

7.5 File Manager

File Manager allows users to check the remaining space of the printer's built-in memory and manage or execute the files saved in the printer's DRAM/Flash memory or micro SD card.

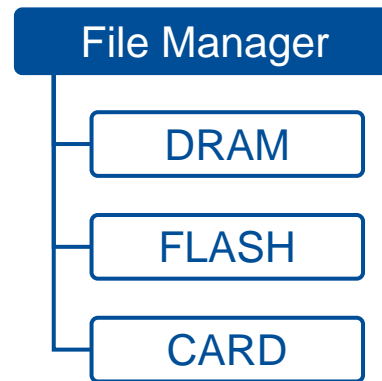

Item	Description
DRAM	Allows users to manage or execute files saved in the printer's DRAM. The executable files must be in .BAS format.
FLASH	Allows users to manage or execute files saved in the printer's Flash memory. The executable files must be in .BAS format.
CARD	Allows users to manage or execute files saved in the micro SD card. The executable files must be in .BAS format. This item will appear when inserting a micro SD card into the printer's card slot.

7.6 Diagnostic

The illustration and table below describe the functions in the **Diagnostic** menu.

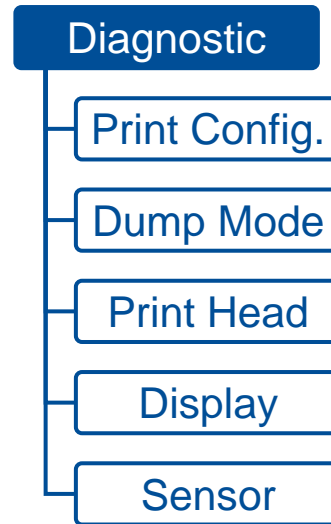

Item	Description
Print Config.	Prints the printer's configurations. You can use this function to check if there is a defective dot on the print heater.
Dump Mode	In this mode, all received characters will be printed in a two-column format. The left column displays the data which is sent from your computer while the right column shows the same data in the hexadecimal format. This function helps engineers troubleshoot a specific problem.

Item	Description
	<div style="display: flex; justify-content: space-between; align-items: center;"> <div style="border: 1px solid black; padding: 5px; margin-left: 100px;">original data</div> <pre style="font-family: monospace; font-size: 0.8em; margin: 0;"> DOWNLOA 0D 0A 44 4F 57 4E 4C 4F 4I D „TEST2. 44 20 22 54 45 53 54 32 2E DAT“,5,CL 44 41 54 22 2C 35 2C 43 4C S DOWNLO 53 0D 0A 44 4F 57 4E 4C 4F AD F,„TES 41 44 20 46 2C 22 54 45 53 T4.DAT“,5 54 34 2E 44 41 54 22 2C 35 ,CLS DOW 2C 43 4C 53 0D 0A 44 4F 57 NLOAD „TE 4E 4C 4F 41 44 20 22 54 45 ST2.DAT“, 53 54 32 2E 44 41 54 22 2C 5,CLS DO 35 2C 43 4C 53 0D 0A 44 4F WNLOAD F, 57 4E 4C 4F 41 44 20 46 2C „TEST4.DA 22 54 45 53 54 34 2E 44 41 T“,5,CLS 54 22 2C 35 2C 43 4C 53 0D DOWNLOAD 0A 44 4F 57 4E 4C 4F 41 44 „TEST2.D 20 22 54 45 53 54 32 2E 44 AT“,5,CLS 41 54 22 2C 35 2C 43 4C 53 DOWNLOAD 0D 0A 44 4F 57 4E 4C 4F 4I D F,„TEST 44 20 46 2C 22 54 45 53 54 4.DAT“,5, 34 2E 44 41 54 22 2C 35 2C CLS 43 4C 53 0D 0A </pre> <div style="border: 1px solid black; padding: 5px; margin-right: 100px;">same data in hexadecimal format</div> </div>
Print Head	Displays the printhead's temperature and the amount of the defective dots.
Display	Checks the LCD's health status.
Sensor	Configures the intensity and reading power for the gap and black mark sensor.

7.7 Favorites

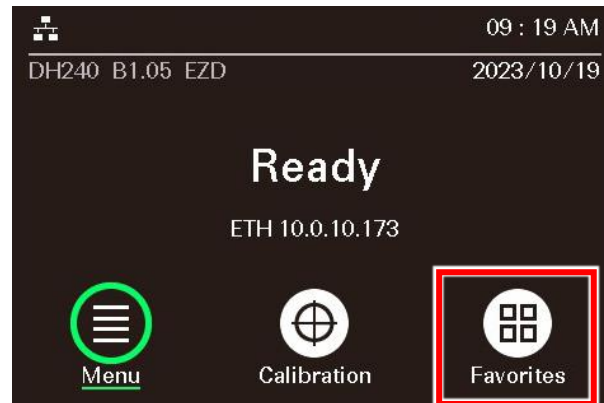

Favorites provides quick access to the mostly used functions. Follow the steps below to add your mostly used functions into the favorites list:

1. Select and hold the item you want to add into the favorites list.

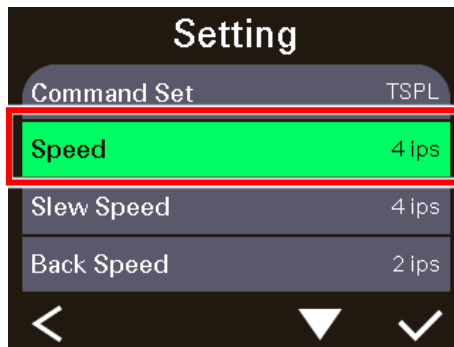

2. When the **Join Favorites** screen is displayed, select **Yes** to add the selected item into the favorites list.

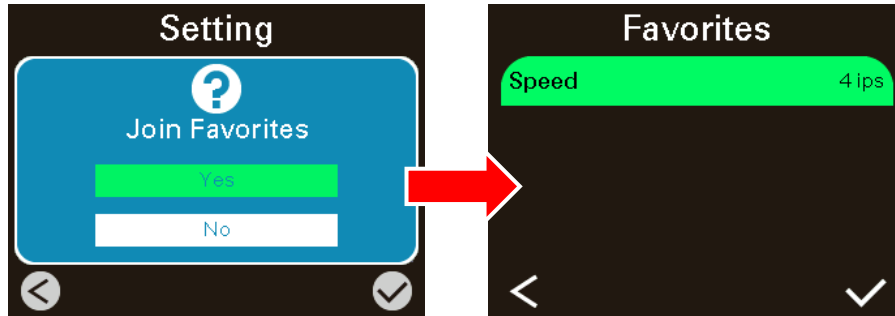

To remove items from your favorites list:

1. Enter the favorites list. Select and hold the item you want to remove from the favorites list.



2. When the **Delete Favorites** screen is displayed, select **Yes** to remove the selected item from the favorites list.

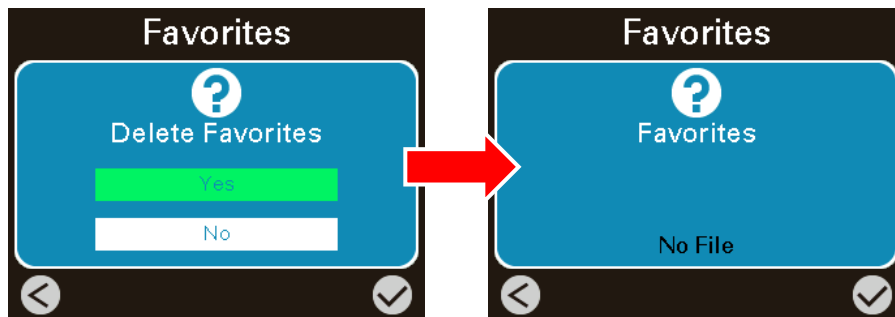

7.8 Configuring the Printer and Setting Options for the Linerless Media

1. After loading the linerless media into the printer, perform the calibration  to calibrate the media sensor (**Continuous**).
2. When the calibration is finished, enter the printer LCD Menu to configure the linerless printer. Select **Setting**. Make sure the **Command Set** is set to **TSPL**.
For linerless cutter module, select **Print Mode** and set the print mode to **Cutter Mode**.
For linerless tear module, select **Print Mode** and set the print mode to **Peeler Mode**.

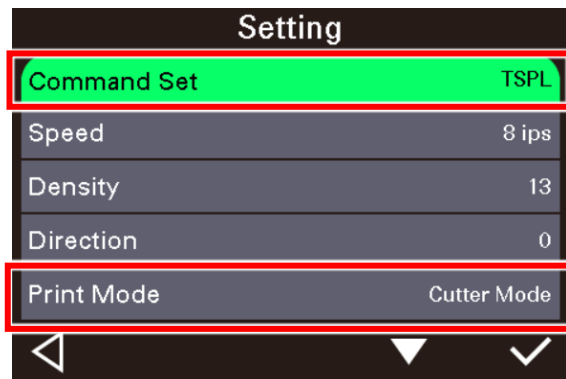

NOTE:

The **Print Mode** can also be set through the **Driver** or the **TSC Console**.

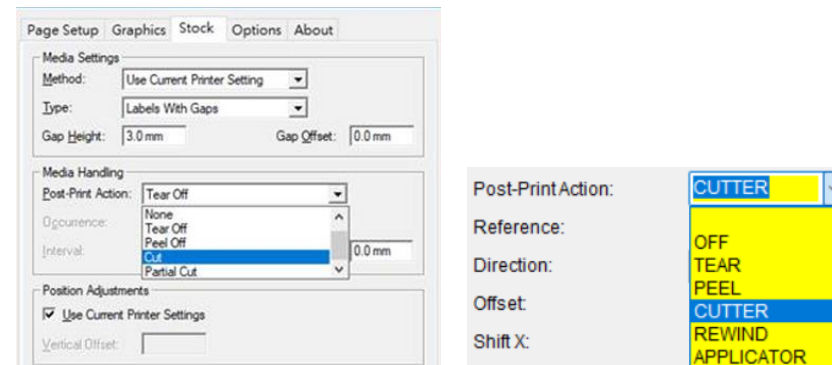

The following paragraph describes the setting options that help optimize the print quality when using the linerless media. The setting options will automatically appear in the **Favorites** folder after installing the linerless cutter/tear module onto the printer.

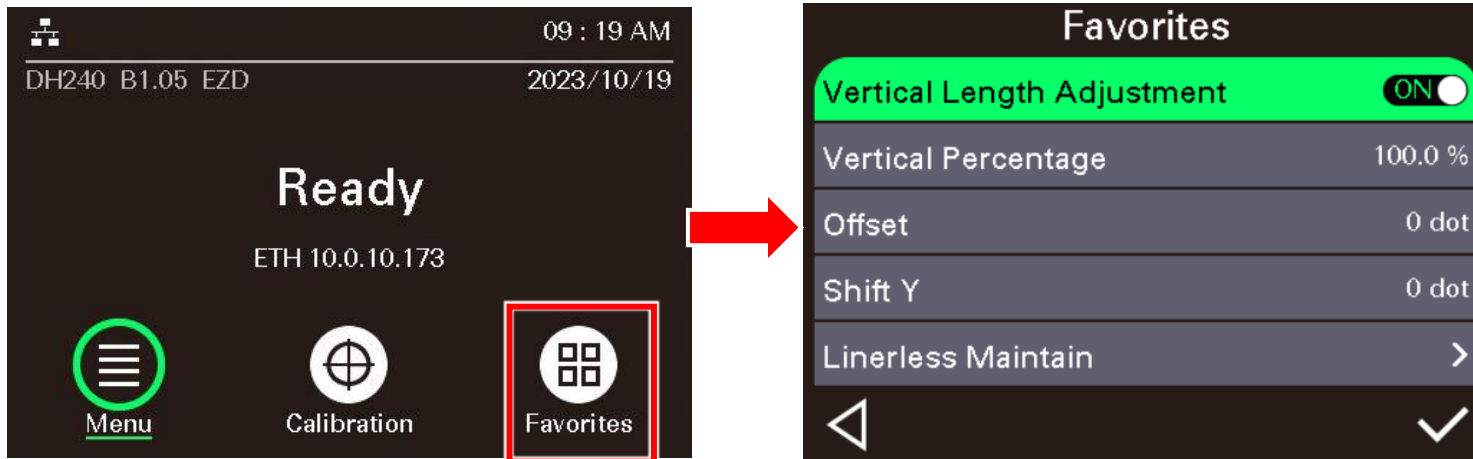

Item	Description
Vertical Length Adjustment (ON)	Turns on/off the Vertical Length Adjustment function. Setting option: ON / OFF .
Vertical Percentage	Adjusts the label length. This item will not appear if Vertical Length Adjustment is turned off. Setting range: 90 to 115%.
Offset	Specifies the stop position for each operation. Setting range: -203 to 203 dots.
Shift Y	Specifies the amount to shift an image vertically up or down for precise print position on the label. Setting range: -203 to 203 dots.

Item	Description
<p style="text-align: center;">Linerless Maintain</p>	<p>Sets how often the printer should be cleaned after printing with the linerless media.</p> <p>Warning: Turns on/off notification that reminds users to clean the printer if the set mileage is fulfilled. (Default setting: ON)</p> <p>Interval: Schedules printer maintenance after printing with the linerless media. When the set amount of mileage is fulfilled, the warning icon () that reminds users to clean the printer will appear on the display panel. (Default setting: 1 km)</p> <p>Clean Cutter Blade: Lifts up to expose the cutter blade. Select this item to lift up the cutter blade if you need to clean the blade.</p> <p>NOTE: Clean Cutter Blade will be displayed in the menu after installing the cutter module on the printer. For how to clean the linerless cutter blade, please refer to Cleaning Procedures section for more information.</p> <p>CAUTION: To avoid the risk of personal injury, keep your hands away from the cutter gate when selecting Clean Cutter Blade. Selecting this item will lift up the blade.</p> <p>Reset Counter: Resets the mileage count after cleaning the printer.</p>

8 Troubleshooting

8.1 Common Problems

Problem	Possible Cause	Recommended Solution
Power indicator does not illuminate	The power cord is not properly connected.	<ul style="list-style-type: none"> • Plug the power cord in printer and outlet. • Switch the printer on. • Turn on the printer.
LED turn on (Carriage Open)	The printer head is open.	Please close the print carriages.
Not Printing	<ul style="list-style-type: none"> • Check if interface cable is well connected to the interface connector. • Check if wireless or Bluetooth device is well connected between host and printer. • The port specified in the Windows driver is not correct. 	<ul style="list-style-type: none"> • Re-connect cable to interface or change a new cable. • If using serial cable, <ul style="list-style-type: none"> • Please replace the cable with pin to pin connected. • Check the baud rate setting. The default baud rate setting of printer is 9600, n, 8, and 1. • If using the Ethernet cable, <ul style="list-style-type: none"> • Check if the Ethernet RJ-45 connector green LED is lit on. • Check if the Ethernet RJ-45 connector amber LED is blinking. • Check if the printer gets the IP address when using DHCP mode. • Check if the IP address is correct when using the static IP address. • Wait a few seconds let the printer get the communication with the server

Problem	Possible Cause	Recommended Solution
		<p>then check the IP address setting again.</p> <ul style="list-style-type: none"> • Please reset the wireless device setting. • Select the correct printer port in the driver. • Print head's harness connector is not well connected with printhead. Turn off the printer and plug the connector again. • Check your program if there is a command PRINT at the end of the file and there must have CRLF at the end of each command line.
No print on the label	<ul style="list-style-type: none"> • Label or ribbon is loaded not correctly. • Use wrong type paper or ribbon 	<ul style="list-style-type: none"> • Follow the instructions in loading the media and ribbon. • Ribbon and media are not compatible. • Verify the ribbon-inked side. • The print density setting is incorrect. • Clean the print head.
No Ribbon	<ul style="list-style-type: none"> • Running out of ribbon. • The ribbon is installed incorrectly. 	<ul style="list-style-type: none"> • Supply a new ribbon roll. • Please refer to the steps in user's manual to reinstall the ribbon.
No Paper	<ul style="list-style-type: none"> • Running out of label. • The label is installed incorrectly. • Gap/black mark sensor is not calibrated. 	<ul style="list-style-type: none"> • Supply a new label roll. • Reinstall the label roll. • Calibrate the gap/black mark sensor.

Problem	Possible Cause	Recommended Solution
Paper jam	<ul style="list-style-type: none"> Gap/black mark sensor is not set properly. Make sure label size is set properly. Labels may be stuck inside the printer mechanism. 	<ul style="list-style-type: none"> Calibrate the media sensor. Set media size correctly. Remove the stuck label inside the printer mechanism.
Can't downloading the file to memory (FLASH / CARD)	The space of memory is full.	Delete unused files in the memory.
SD card is unable to use	<ul style="list-style-type: none"> SD card is damaged. SD card doesn't insert correctly. Use the non-approved SD card manufacturer. 	<ul style="list-style-type: none"> Use the supported capacity SD card. Insert the SD card again.
Poor Print Quality	<ul style="list-style-type: none"> Ribbon and media is loaded incorrectly Dust or adhesive accumulation on the print head. Print density is not set properly. Print head element is damaged. Ribbon and media are incompatible. The print head pressure is not set properly. 	<ul style="list-style-type: none"> Reload the supply. Clean the print head. Clean the platen roller. Adjust the print density and print speed. Run printer self-test and check the print head test pattern if there is dot missing in the pattern. Change proper ribbon or proper label media. The release lever does not latch the print head properly.
Missing printing on the left or right side of label	Wrong label size setup.	Set the correct label size.
Gray line on the blank label	<ul style="list-style-type: none"> The print head is dirty. 	<ul style="list-style-type: none"> Clean the print head.

Problem	Possible Cause	Recommended Solution
	<ul style="list-style-type: none"> The platen roller is dirty. 	<ul style="list-style-type: none"> Clean the platen roller.
Irregular printing	<ul style="list-style-type: none"> The printer is in Hex Dump mode. The RS-232 setting is incorrect. 	<ul style="list-style-type: none"> Turn off and on the printer to skip the dump mode. Re-set the Rs-232 setting.
Label feeding is not stable (skew) when printing	The media guides do not touch the edge of the media.	<ul style="list-style-type: none"> If the label is moving to the right side, please move the label guide to left. If the label is moving to the left side, please move the label guide to right.
Skip labels when printing	<ul style="list-style-type: none"> Label size is not specified properly. Sensor sensitivity is not set properly. The media sensor is covered with dust. 	<ul style="list-style-type: none"> Check if label size is setup correctly. Calibrate the sensor by Auto Gap or Manual Gap options. Clear the GAP/Black mark sensor by blower.
Wrinkle Problem	<ul style="list-style-type: none"> Printhead pressure is incorrect. Ribbon installation is incorrect. Media installation is incorrect. Print density is incorrect. Media feeding is incorrect. 	<ul style="list-style-type: none"> Please set the suitable density to have good print quality. Make sure the label guides touch the edge of the media guide.
RTC time is incorrect when reboot the printer	The battery has run down.	Check if there is a battery on the main board.
The left side printout position is incorrect	<ul style="list-style-type: none"> Wrong label size setup. The parameter Shift X in printer is incorrect. 	Set the correct label size.

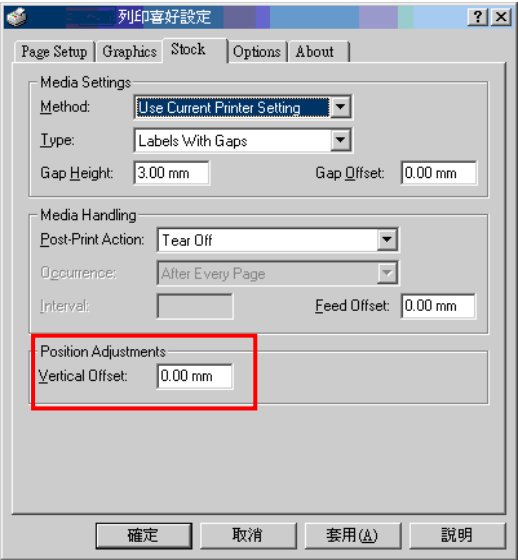
Problem	Possible Cause	Recommended Solution
<p>The printing position of small label is incorrect</p>	<ul style="list-style-type: none"> Media sensor sensitivity is not set properly. Label size is incorrect. The parameter Shift Y is incorrect. The vertical offset setting in the driver is incorrect. 	<ul style="list-style-type: none"> Calibrate the sensor sensitivity again. Set the correct label size and gap size. Enter LCD menu (or via TSC Console) to fine tune the parameter of Shift Y. If using the software BarTender, please set the vertical offset in the driver. 

9 Maintenance

This section provides cleaning and maintenance procedures.

Cleaning:

Depending on the media used, the printer may accumulate residues (media dust, adhesives, etc.) as a by-product of normal printing. To maintain the best printing quality, you should remove these residues by cleaning the printer periodically. Regularly clean the print head and supply sensors once change a new media to keep the printer at the optimized performance and extend printer life.

Disinfecting:

Disinfecting the printer helps protect yourself and other users and helps prevent virus from spreading.

IMPORTANT:

- Set the printer power switch to O (Off) prior to performing any cleaning or disinfecting tasks. Leave the power cord connected to keep the printer grounded and to reduce the risk of electrostatic damage.
- Do not wear rings or other metallic objects while cleaning any interior area of the printer.
- Use only the cleaning agents recommended in this document. Use of other agents may damage the printer and void its warranty.
- Do not spray or drip liquid cleaning solutions directly into the printer. Apply the solution on a clean lint-free cloth and then apply the dampened cloth to the printer.
- Do not use canned air in the interior of the printer as it can blow dust and debris onto sensors and other critical components.
- Only use a vacuum cleaner with a nozzle and hose that are conductive and grounded to drain off static build up.
- All reference in these procedures for use of isopropyl alcohol requires that a 99% or greater isopropyl alcohol content be used to reduce the risk of moisture corrosion to the printhead.
- Do not touch printhead by hand. If you touch it carelessly, please use 99% Isopropyl alcohol to clean it.
- Always taking personal precaution when using any cleaning agent.

9.1 Cleaning Supplies

The following supplies are recommended for cleaning the printer:

- Cotton swab
- Lint-free cloth
- Brush with soft and non-metallic bristles
- Vacuum cleaner
- 75% Ethanol used for disinfection
- 99% Isopropyl alcohol used for cleaning the printhead and platen roller
- Genuine printhead cleaning pens
- Chlorine free detergents

9.2 Cleaning Procedures

Component	Method	Recommended Cleaning Frequency
Printhead	<ol style="list-style-type: none"> 1. Power off the printer before cleaning the printhead. 2. Leave the printhead to cool down for at least one minute. 3. Wet a cotton swab with the 99% Isopropyl alcohol and then wipe across the printhead head. You can also use the genuine printhead cleaning pen to clean the printhead. 	Clean the printhead when you load new media.
Platen Roller	<ol style="list-style-type: none"> 1. Power off the printer. 2. Use a piece of 99% Isopropyl alcohol saturated lint-free cloth to wipe the platen roller while rotating the platen roller. 	Clean the platen roller when you load new media.
Peel Bar	Use a piece of 99% Isopropyl alcohol saturated lint-free cloth to wipe the peel bar.	Clean as needed.
Sensor	Use the brush with soft and non-metallic bristles or vacuum cleaner to remove the dust or particles in order to optimize the print quality or sensor calibration.	Clean the sensor monthly.
Exterior	Use a piece of water-dampened lint-free cloth to wipe the surface. If necessary, you can apply the chlorine free detergent. After finishing cleaning, use the 75% ethanol to disinfect the surface.	Clean as needed.
Interior	Use the brush with soft and non-metallic bristles or vacuum cleaner to remove the dust or particles. After finishing cleaning, use the 75% ethanol to disinfect the interior.	Clean as needed.
Linerless Printer	<p>Please refer to Linerless Cleaning Kit User Manual for more information.</p> 	<ul style="list-style-type: none"> • Clean as needed or after printing every 1 km. • Please determine the maintenance based on actual usage.

10 Agency Compliance and Approvals



EN 55032: Class B
EN 55035
EN IEC 61000-3-2 Class A
EN 61000-3-3
EN 300328 (Optional)
EN 301893 (Optional)
EN 62311 (Optional)
EN 301489-1-17 (Optional)
EN 62368-1



FCC part 15B, Class B
FCC part 15C (Optional)
ICES-003, Class B

This equipment has been tested and found to comply with the limits for a Class B digital device, pursuant to part 15 of the FCC Rules. These limits are designed to provide reasonable protection against harmful interference in a residential installation. This equipment generates, uses and can radiate radio frequency energy and, if not installed and used in accordance with the instructions, may cause harmful interference to radio communications. However, there is no guarantee that interference will not occur in a particular installation. If this equipment does cause harmful interference to radio or television reception, which can be determined by turning the equipment off and on, the user is encouraged to try to correct the interference by one or more of the following measures:

- Reorient or relocate the receiving antenna.
- Increase the separation between the equipment and receiver.
- Connect the equipment into an outlet on a circuit different from that to which the receiver is connected.
- Consult the dealer or an experienced radio/TV technician for help.

This equipment complies with Part 15 of FCC Rules. Operation is subject to the following two conditions: (1) This device may not cause harmful interference, and (2) this device must accept any interference received, including interference that may cause undesired operation.

This Class B digital apparatus complies with Canadian ICES-003.
Cet appareil numérique de la classe B est conforme à la norme NMB-003 du Canada.



AS/NZS CISPR 32, Class B
AS/NZS 4268:2017 (Optional)



UL 62368-1:2019
CSA C22.2 No. 62368-1:2019



KS C 9832
KS C 9835
KS X 3124:2020 (Optional)
KS X 3126:2020 (Optional)

KC62368-1

이 기기는 업무용(B 급) 전자파적합기기로서 판매자 또는 사용자는 이 점을 주의하시기 바라며, 가정외의 지역에서 사용하는 것을 목적으로 합니다.



GB 4943.1
GB/T 9254.1, Class B
GB 17625.1



Energy Star for Imaging Equipment Version 3.2



TP TC 004
TP TC 020



CNS15598-1
CNS15936
CNS 15663



IS 13252(Part 1)/
IEC 60950-1



BS EN 55032: Class B
BS EN 55035
BS EN IEC 61000-3-2
BS EN 61000-3-3



NOM-019



LP0002 **(Optional)**



TELEC-T401 **(Optional)**
Japanese radio regulation 2008



45 (E) Dated 28-01-2005 **(Optional)**
1048 (E) Dated 18-10-2018

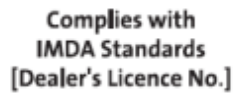

IMDA TS SRD **(Optional)**



เครื่องวิทยุคมนาคมนี้ ได้รับยกเว้น ไม่ต้องได้รับ
ใบอนุญาตให้มี ใช้ซึ่งเครื่องวิทยุคมนาคม
หรือตั้งสถานีวิทยุคมนาคมตามประกาศ กสทช.
เรื่อง เครื่องวิทยุคมนาคม และสถานีวิทยุ
คมนาคมที่ได้รับยกเว้นไม่ต้องได้รับใบอนุญาต
วิทยุคมนาคม ตามพระราชบัญญัติวิทยุ
คมนาคม พ.ศ. 2498



nanc. | โทรคมนาคม
กำกับดูแลเพื่อประชาชน
Call Center 1200 (1นสว5)

“เครื่องโทรคมนาคมและอุปกรณ์นี้มีความสอดคล้องตามมาตรฐานหรือข้อกำหนดทางเทคนิคของ กสทช.”
(Optional)

備註：不同型號可能會有不同認證，一切以產品上的認證標籤為準。

Important safety instructions:

Read all of these instructions and keep them for later use.

- Follow all warnings and instructions on the product.
- Disconnect the power from the AC inlet before cleaning or if fault happened. Do not use liquid or aerosol cleaners. Using a damp cloth is suitable for cleaning.

- The mains socket shall be installed near the equipment and easily accessible.
- The unit must be protected against moisture.
- Ensure the stability when installing the device, Tipping or dropping could cause damage.
- Make sure to follow the correct power rating and power type indicated on marking label provided by manufacture.
- Please refer to user manual for maximum operation ambient temperature.

重要安全說明：

閱讀所有說明，並保留以備未來使用。

- 依照產品上的所有警告和說明進行操作。
- 在清潔前或發生故障時，拔除電源插頭與交流電源插座的連接。不要使用液體或噴霧清潔劑。建議使用濕布清潔。
- 電源插座應安裝在設備附近及方便使用處。
- 本機器必須防止潮濕。
- 確保安裝設備時的穩定性，翻倒或跌落可能會導致設備損壞。
- 確保按照製造商提供的標籤上標明之正確的額定功率和電源類型進行設定。
- 請參考使用手冊以確認產品運作時環境溫度的最大值。

Informations de sécurité importantes:

Lire attentivement et conserver ces instructions pour un usage ultérieur.

- Bien respecter les avertissements et instructions sur le produit.
- Débrancher l'alimentation de l'entrée CA avant de procéder au nettoyage ou en cas de dysfonctionnement. Ne pas utiliser de nettoyant liquide ou d'aérosol. Nettoyer simplement à l'aide d'un chiffon humide.
- La prise électrique doit être installée à proximité de l'appareil et être facilement accessible.
- L'appareil doit être protégé de l'humidité.
- Assurez-vous que l'unité est installée de manière stable pour un usage et une manipulation sans risque de chute.
- Respecter le type d'alimentation et la puissance nominale indiqués par le fabricant.
- Se reporter au mode d'emploi pour vérifier les températures maximum d'utilisation recommandées.



WARNING:

Moving parts. Keep finger or body away from moving parts.

IMPORTANT:

Pièces mobiles. Maintenir vos doigts et votre corps à l'écart des pièces mobiles.

CAUTION:

(For equipment with RTC (CR2032) battery or rechargeable battery pack)

Risk of explosion if battery is replaced by an incorrect type.

Dispose of used batteries according to the Instructions as below.

- DO NOT throw the battery in fire.
- DO NOT short circuit the contacts.
- DO NOT disassemble the battery.
- DO NOT throw the battery in municipal waste.
- The symbol of the crossed out wheeled bin indicates that the battery should not be placed in municipal waste.

警告：

(對於帶有 RTC(CR2032)電池或可充電電池組的設備)

如果更換不正確的電池類型，會有爆炸的風險。

請依照以下說明處理廢電池：

- 請勿將電池投入火中。
- 請勿使觸點短路。
- 請勿拆解電池。
- 請勿將電池丟入都市廢棄物。
- 垃圾桶畫叉圖案表示電池不應該放置在都市廢棄物中。

ATTENTION:

(Pour les appareils équipés d'une batterie RTC (CR2032) ou de batteries rechargeables)

Risque d'explosion en cas de remplacement de la batterie par une référence non conforme.

La batterie usagée :

- NE DOIT PAS être mise au feu.
- NE DOIT PAS être mise en court-circuit.
- NE DOIT PAS être ouverte ou démontée.
- NE DOIT PAS être jetée avec les ordures ménagères.
- L'icône de poubelle barrée indique que la batterie ne doit pas être jetée avec les ordures ménagères.



Caution: Hot surface for printhead.

Do not touch the printhead before it cools down.

ATTENTION : Surface de la tête d'impression chaude.

Ne pas toucher la tête d'impression avant qu'elle ait refroidi.

WARNING:

Remove the power from AC inlet before opening the media cover for cleaning or repairing faults. After cleaning or fixing faults, media cover closing before power connecting to AC inlet.

IMPORTANT:

Retirer l'alimentation de l'entrée CA avant d'ouvrir le capot des consommables pour procéder au nettoyage ou à la réparation de l'appareil. Après avoir effectué le nettoyage ou corrigé les dysfonctionnements, fermez le capot des consommables avant de brancher l'alimentation à l'entrée CA.

CAUTION:

Any changes or modifications not expressly approved by the grantee of this device could void the user's authority to operate the equipment.

CE Statement:

This equipment complies with EU radiation exposure limits set forth for an uncontrolled environment. This equipment should be installed and operated with minimum distance 20 cm between the radiator and your body.

All operational modes:

2.4GHz: 802.11b, 802.11g, 802.11n (HT20), 802.11n (HT40)

5GHz: 802.11a, 802.11ac

The frequency, mode and the maximum transmitted power in EU are listed below:

2400 MHz – 2483.5 MHz: 19.88 dBm (EIRP)

5150 MHz – 5250 MHz: 17.51 dBm (EIRP)

5150-5350MHz for only indoor use

5470-5725MHz for indoor/outdoor use

Restrictions in AZE

National restrictions information is provided below

Frequency Band	Country	Remark
5150-5350MHz	Azerbaijan	No license needed if used indoor and power not exceeding 30mW
5470-5725MHz		

Hereby, TSC Auto ID Technology Co., Ltd. declares that the radio equipment type [Wi-Fi] IEEE 802.11 a/b/g/n/ac is in compliance with Directive 2014/53/EU.

The full text of the EU declaration of conformity is available at the following internet address: [http:// www.tscprinters.com](http://www.tscprinters.com)

RF Exposure Warning for Wi-Fi

This equipment must be installed and operated in accordance with provided instructions and must not be co-located or operating in conjunction with any other antenna or transmitter. End-users and installers must be providing with antenna installation instructions and transmitter operating conditions for satisfying RF exposure compliance.

SAR Value: 0.736 W/kg

RF Exposure Warning for Bluetooth

The equipment complies with FCC RF exposure limits set forth for an uncontrolled environment.

The equipment must not be co-located or operating in conjunction with any other antenna or transmitter.

Canada, Industry Canada (IC) Notices

This Class B digital apparatus complies with Canadian ICES-003 and RSS-210.

Operation is subject to the following two conditions: (1) this device may not cause interference, and (2) this device must accept any interference, including interference that may cause undesired operation of the device.

Radio Frequency (RF) Exposure Information

The radiated output power of the Wireless Device is below the Industry Canada (IC) radio frequency exposure limits. The Wireless Device should be used in such a manner such that the potential for human contact during normal operation is minimized.

This device has been evaluated for and shown compliant with the IC Specific Absorption Rate ("SAR") limits when installed in specific host products operated in portable exposure conditions. **(For Wi-Fi)**

This device has also been evaluated and shown compliant with the IC RF Exposure limits under portable exposure conditions. (Antennas are less than 20 cm of a person's body). **(For Bluetooth)**

Canada, avis de l'Industry Canada (IC)

Cet appareil numérique de classe B est conforme aux normes canadiennes ICES-003 et RSS-210.

Son fonctionnement est soumis aux deux conditions suivantes : (1) cet appareil ne doit pas causer d'interférence et (2) cet appareil doit accepter toute interférence, nota 毫米 ent les interférences qui peuvent affecter son fonctionnement.

Informations concernant l'exposition aux fréquences radio (RF)

La puissance de sortie émise par l'appareil sans fil est inférieure à la limite d'exposition aux fréquences radio de l'Industry Canada (IC). Utilisez l'appareil sans fil de façon à minimiser les contacts humains lors du fonctionnement normal.

Ce périphérique a été évalué et démontré conforme aux limites SAR (Specific Absorption Rate – Taux d'absorption spécifique) par l'IC lorsqu'il est connecté à des dispositifs hôtes spécifiques opérant dans des conditions d'utilisation mobile. **(Pour le Wi-Fi)**

Ce périphérique a également été évalué et démontré conforme aux limites d'exposition radio-fréquence par l'IC pour des utilisations par des opérateurs mobiles (les antennes sont à moins de 20 cm du corps d'une personne). **(Pour le Bluetooth)**

NCC 警語：

經型式認證合格之低功率射頻電機，非經許可，公司、商號或使用者均不得擅自變更頻率、加大功率或變更原設計之特性及功能。(即低功率電波輻射性電機管理辦法第十二條)

低功率射頻電機之使用不得影響飛航安全及干擾合法通信；經發現有干擾現象時，應立即停用，並改善至無干擾時方得繼續使用。

前項合法通信，指依電信法規定作業之無線電通信。低功率射頻電機須忍受合法通信或工業、科學及醫療用電波輻射性電機設備之干擾。(即低功率電波輻射性電機管理辦法第十四條)

限用物質含有情況標示聲明書 / Declaration of the Presence Condition of the Restricted Substances Marking

設備名稱(Equipment Name)：熱轉式/熱感式條碼印表機 型號(Type Designation)：TH240						
單元Unit	限用物質及其化學符號 (Restricted substances and its chemical symbols)					
	鉛 Lead (Pb)	汞 Mercury (Hg)	鎘 Cadmium (Cd)	六價鉻 Hexavalent chromium (Cr+6)	多溴聯苯 Polybrominated biphenyls (PBB)	多溴二苯醚 Polybrominated diphenyl ethers (PBDE)
內外塑膠件	○	○	○	○	○	○
內外鐵件	-	○	○	○	○	○
滾輪	○	○	○	○	○	○
電路板	-	○	○	○	○	○
晶片電阻	-	○	○	○	○	○
積層陶瓷表面黏著電容	○	○	○	○	○	○
集成電路-IC	-	○	○	○	○	○
電源供應器	○	○	○	○	○	○
印字頭	-	○	○	○	○	○
插座	-	○	○	○	○	○
線材	-	○	○	○	○	○
<p>備註一：“超出0.1 wt %”及“超出0.01 wt %”係指限用物質之百分比含量超出百分比含量基準值。 Note 1：“Exceeding 0.1 wt %” and “exceeding 0.01 wt %” indicate that the percentage content of the restricted substance exceeds the reference percentage value of presence condition.</p> <p>備註二：“○”係指該項限用物質之百分比含量未超出百分比含量基準值。 Note 2：“○” indicates that the percentage content of the restricted substance does not exceed the percentage of reference value of presence.</p> <p>備註三：“-”係指該項限用物質為排除項目。 Note 3：The “-” indicates that the restricted substance corresponds to the exemption.</p>						

Revision History

Date	Description	Technical Writer
2023/11/15	Official release.	Peter Yao
2023/12/22	Added the warning mark on page 23, 25, 30, and 32.	Peter Yao
2024/03/21	<ul style="list-style-type: none">▪ Updated the Web User Interface section on page 41 and 42.▪ Added “Linerless Maintain” in the “Advanced” menu on page 74 and 76▪ Updated the “Favorites” section and added information about how to configure the linerless printer from page 80 to 84.▪ Added information about how to clean the linerless printer on page 92.	Peter Yao
2024/10/21	Updated the TUV regulations and its mark on page 94.	Peter Yao



www.tscprinters.com