

Industrial Barcode Printer

MB241 Series

Thermal Transfer • Direct Thermal

Series Models

MB241/MB341

MB241T/MB341T



User Manual

Copyright Information

©2024 TSC Auto ID Technology Co., Ltd.

The copyright in this manual, the software and firmware in the printer described are owned by TSC Auto ID Technology Co., Ltd. All rights reserved.

CG Triumvirate is a trademark of Agfa Corporation. CG Triumvirate Bold Condensed font is under license from the Monotype Corporation. Windows is a registered trademark of Microsoft Corporation.

All other trademarks are the property of their respective owners. Information in this document is subject to change without notice and does not represent a commitment on the part of TSC Auto ID Technology Co. No part of this manual may be reproduced or transmitted in any form or by any means, for any purpose other than the purchaser's personal use, without the expressed written permission of TSC Auto ID Technology Co.

Table of Contents

1. Introduction	1
1.1 Product Specification	2
1.2 Unpacking and Inspection	6
2. Operation Overview	7
2.1 Printer Overview	7
2.2 LCD Operator Control	10
2.3 Power-on Utilities	15
2.4 Web User Interface	16
3. Setup	21
3.1 Setting up the Printer	21
3.2 Loading the Ribbon	22
3.3 Loading the Media	24
3.4 Loading the Fanfold/External Media	26
3.5 Loading the Media in Peel-off Mode (Optional)	27
3.6 Loading the Media in Cutter Mode (Optional)	30
3.7 Loading the Linerless Media (Optional)	31
4. Knob Adjustment	34
4.1 Printhead Pressure Adjustment Knob	34
4.2 Ribbon Tension Adjustment Knob	35
4.3 Mechanism Fine Adjustment to Avoid Ribbon Wrinkles	36
5. TSC Console	39
5.1 Start TSC Console	39
5.2 Set Ethernet and Add to TSC Console Interface	41
5.3 Set Wi-Fi and Add to TSC Console Interface	43
5.4 Initialize the Printer Wi-Fi Setting	46
5.5 Printer Function	47

- 6. LCD Menu Function48**
 - 6.1 Enter the Menu48
 - 6.2 Menu Overview49
 - 6.3 Setting50
 - 6.4 Sensor56
 - 6.5 Interface58
 - 6.6 Advanced61
 - 6.7 File Manager65
 - 6.8 Diagnostic66
 - 6.9 Favorites (Touch LCD Only)67
 - 6.10 Configuring the Printer and Setting Options for the Linerless Media69
- 7. Troubleshooting72**
- 8. Maintenance76**
- 9. Agency Compliance and Approvals79**
- 10. Revision History87**

1. Introduction

TSC MB241 series of industrial thermal label printers is the 4" wide light industrial label printing.

The MB241 boasts a bifold media door, cutting operational space requirements by 24%. Its all-metal print mechanism guarantees durability in high-volume printing. Engineered for top-notch printing, even on thicker or harder labels, it includes accessories like linerless kits, peel-off kits, internal rewinder kits, and cutters, amplifying functionality to meet dynamic business demands.

The printer capabilities are designed with auto-switching emulation for hassle-free deployment. TSC Standalone Creator generates printer LCD UI for quick template access, while TSCPRTGo acts as an extended display for mobile printing. SOTI Connect, TSC Console, and the Internal Embedded Webpage enable remote fleet management.

The eco-friendly MB241 printer boasts 100% recyclable packaging and casing, with over 90% recyclable components, minimizing its environmental impact. It's ideal for limited space and excels in print quality and versatility, making it an outstanding choice for various printing needs.

This manual provides the essential information and clear instructions for operating MB241 series. To print label formats, please refer to the instructions provided with your labeling software. TSC printers include the Windows labeling software for creating your label template. For system integration, the TSPL/TSPL2 printer programming manual or SDKs can be found on TSC website at <https://www.tscprinters.com>

1.1 Product Specification

Item \ Model	MB241	MB341	MB241T	MB341T
Resolution	8 dots/mm (203 dpi)	12 dots/mm (300 dpi)	8 dots/mm (203 dpi)	12 dots/mm (300 dpi)
Printing Method	Thermal Transfer & Direct Thermal			
Max. Print Speed	304.8mm (12")/second	228.6mm (9")/second	304.8mm (12")/second	228.6mm (9")/second
Max. Print Width	107mm (4.21")	105.7mm (4.16")	107mm (4.21")	105.7mm (4.16")
Max. Print Length	25,400mm (1000")	11,430mm (450")	25,400mm (1000")	11,430mm (450")
Enclosure	Die-cast based print mechanism/Metal cover with large clear media view window			
Physical Dimension	248mm(W)x274mm(H)x436mm(D) 9.76"(W)x10.79"(H)x17.17"(D)			
Weight	9.1kg (20.06lbs)			
Label Roll Capacity	203.2mm(8")O.D., 1" - 3" I.D. core			
Ribbon	450m with 1" ribbon core I.D., ink coated outside or inside			
Ribbon Width	40 - 110mm(1.6" - 4.3")			
Processor	32-bit RISC CPU			
Memory	<ul style="list-style-type: none"> ◆ 256MB Flash memory ◆ 256MB SDRAM 			

Item \ Model	MB241	MB341	MB241T	MB341T
Interface	<ul style="list-style-type: none"> ◆ RS-232 ◆ USB 2.0 ◆ Internal Ethernet, 10/100 Mbps ◆ USB host, for scanner or PC keyboard ◆ GPIO (dealer option) ◆ Internal Bluetooth (dealer option) ◆ Internal Bluetooth 5.0 Mfi (factory option) ◆ Slot-in Wi-Fi 802.11 a/b/g/n/ac with Bluetooth 5.0 combo module (dealer option) 			
Power	Internal universal switching power supply <ul style="list-style-type: none"> ◆ Input: AC 100-240V, 2.0A, 50-60Hz ◆ Output: DC 24V, 3.75A, 90W 			
LED/LCD	<ul style="list-style-type: none"> ◆ 2.3" color LCD ◆ 1 LED (with 2 LEDs: green, red) 		<ul style="list-style-type: none"> ◆ 3.5" color touch LCD ◆ 1 LED (with 2 LEDs: green, red) 	
Operation Switch, Button	<ul style="list-style-type: none"> ◆ 1 power switch ◆ 6 buttons (Menu, Pause/Feed, Up, Down, Left, Right) 			
Sensors	<ul style="list-style-type: none"> ◆ Gap transmissive sensor (position adjustable) ◆ Black mark reflective sensor (position adjustable) ◆ Ribbon encoder sensor ◆ Ribbon end sensor ◆ Head open sensor 			
Real Time Clock	Standard			
Internal Fonts	<ul style="list-style-type: none"> ◆ 8 alpha-numeric bitmap fonts ◆ Monotype Imaging® true type font engine with one CG Triumvirate Bold Condensed scalable font 			

Item \ Model	MB241	MB341	MB241T	MB341T
Bar code	<ul style="list-style-type: none"> ◆ 1D bar code Code 39, Code 93, Code128UCC, Code128 subsets A.B.C, Codabar, Interleave 2 of 5, EAN-8, EAN-13, EAN-128, UPC-A, UPC-E, EAN and UPC 2(5) digits add-on, MSI, PLESSEY, POSTNET, RSS-Stacked, GS1 DataBar, Code 11, China Post ◆ 2D bar code PDF-417, Micro PDF 417, Maxicode, DataMatrix, QR code, Aztec, TLC 39, RSS 			
Font & Barcode Rotation	0, 90, 180, 270 degree			
Printer Language	TSPL-EZD (EPL, ZPL, ZPL II, DPL)			
Media Type	Continuous, die-cut, black mark, fan-fold, notched (outside wound)			
Media Width	20mm - 120mm (0.8" - 4.7")			
Media Thickness	0.06mm - 0.28mm (2.36mil - 11mil)			
Media Core Diameter	25.4 - 76.2mm (1" - 3")			
Label Length	5 - 25,400mm(0.2" - 1000")	5 - 11,430mm(0.2" - 450")	5 - 25,400mm(0.2" - 1000")	5 - 11,430mm(0.2" - 450")
Environment Condition	<ul style="list-style-type: none"> ◆ Operation: 0°C to 40°C (32°F to 104°F), 25% - 85% non-condensing ◆ Storage: -40°C to 60°C (-40°F to 140°F), 10% - 90% non-condensing 			
Factory Option	Internal Bluetooth 5.0 MFi			

Model	MB241	MB341	MB241T	MB341T
Item				
Dealer Option	<ul style="list-style-type: none"> ◆ Peel-off kit ◆ Regular guillotine cutter (full cut) ◆ 5" O.D. internal rewinding kit ◆ GPIO ◆ Linerless tear-off kit ◆ Linerless cutter kit ◆ Slot-in Wi-Fi 802.11 a/b/g/n/ac with Bluetooth 5.0 combo upgrade kit (for device without slot-in housing)* ◆ Internal Bluetooth 5.0 module** 			
User option	<ul style="list-style-type: none"> ◆ Slot-in Wi-Fi 802.11 a/b/g/n/ac with Bluetooth 5.0 combo module (for device with slot-in housing) ◆ KP-200 Plus keyboard display unit ◆ Universal cutter tray 			

Note:

*: Either GPIO or Wireless interface is available.

** : Either Wi-Fi with Bluetooth Combo or Internal Bluetooth interface option is available.

1.2 Unpacking and Inspection

This printer has been specially packaged to withstand damage during shipping. Please carefully inspect the packaging and printer. Please retain the packaging materials in case you need to reship the printer.

Unpacking the printer, the following items are included in the carton.

- 1 Printer unit
- 1 Quick start guide
- 1 Power cord
- 1 USB interface cable

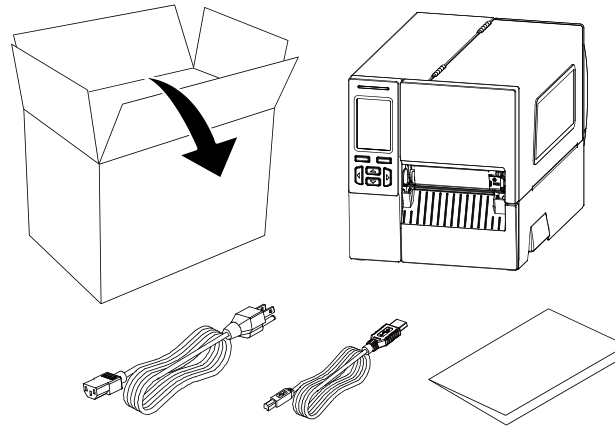

Note: If any parts are missing, please contact the Customer Service Department of your purchased reseller or distributor.

2. Operation Overview

2.1 Printer Overview

2.1.1 Front View

■ MB241 Series



■ MB241T Series



1. LED indicator
2. 2.3" color LCD display
3. Front panel buttons
4. 3.5" color touch LCD
5. Media window
6. Paper exit chute
7. Media cover handle

2.1.2 Interior View

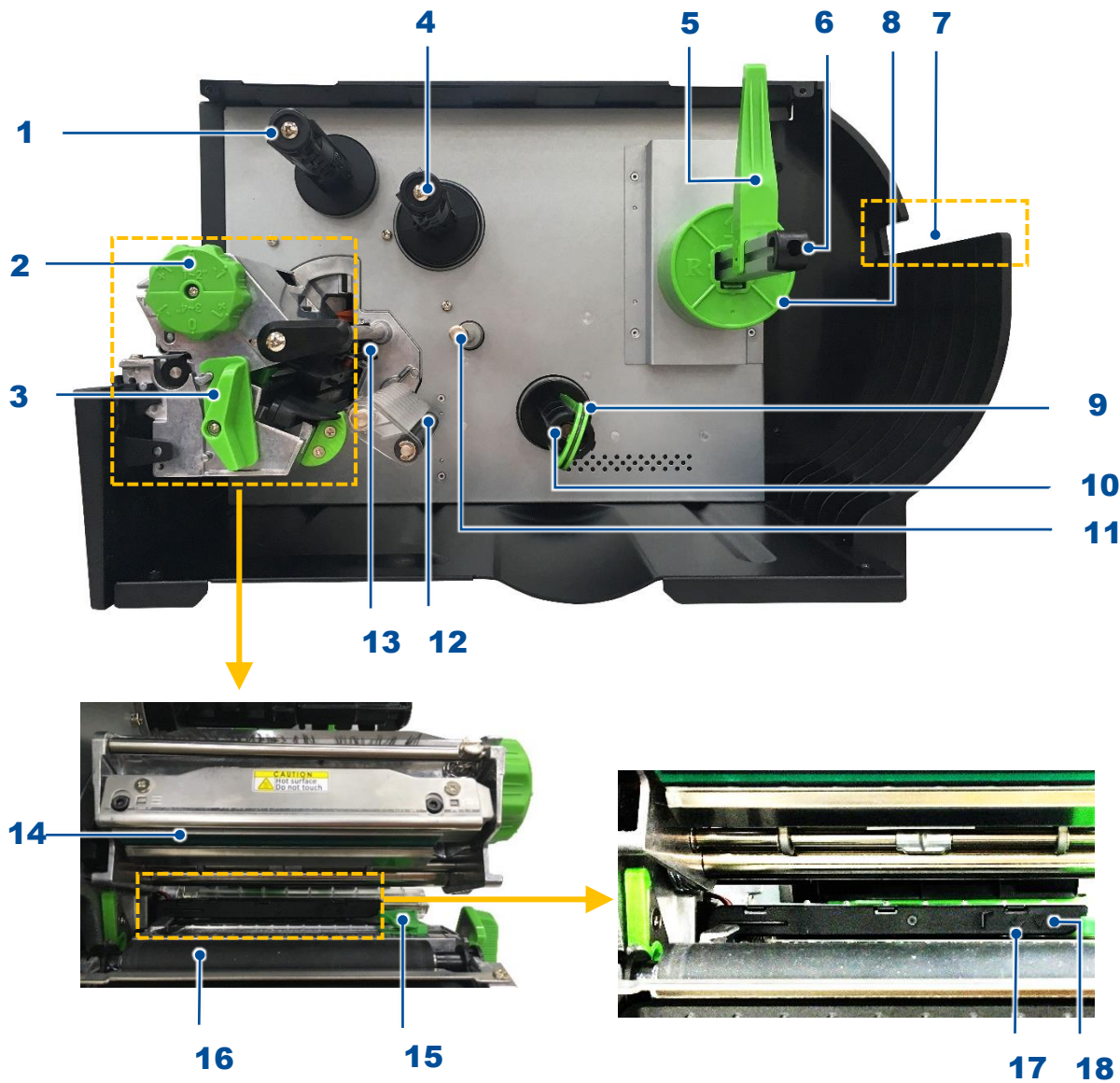

1. Ribbon rewind spindle
2. Print head pressure adjustment knob
3. Print head release lever
4. Ribbon supply spindle
5. Label roll guard
6. Label supply spindle
7. External label entrance chute
8. 3" core adapters
9. Liner securing clip (Optional kit of Peel-off module ass'y)
10. Liner rewind spindle (Optional kit of Peel-off module ass'y)
11. Media guide bar (Optional kit of Peel-off module ass'y)
12. Damper
13. Ribbon end sensor
14. Print head
15. Front label guide
16. Platen roller
17. Black mark sensor (shown as ↓)
18. Gap sensor (shown as ▽)

2.1.3 Rear View

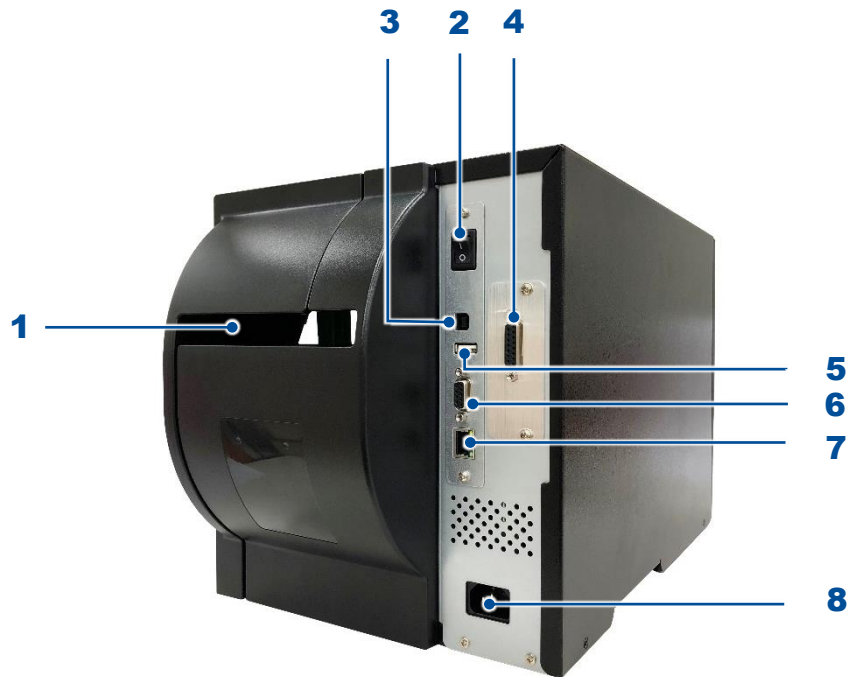

1. External label entrance chute
2. Power switch
3. USB interface (High speed mode)
4. Slot-in Wi-Fi or GPIO interface (Option)
5. USB host
6. RS-232C interface
7. Ethernet interface
8. Power cord socket

Note:

The interface picture here is for reference only. Please refer to the product specification for the interface availability.

2.2 LCD Operator Control

■ MB241 Series





■ MB241T Series





2.2.1 LED Indication and Keypads





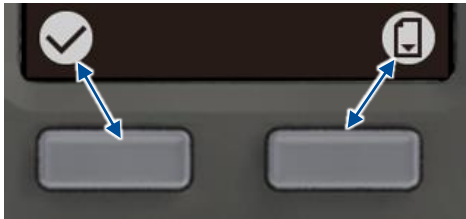

■ LED color indication









Color	Meaning
 (Green)	Solid: Power is on and ready to be used. Flash: System is downloading data or printer is paused.
 (Amber)	System is clearing data.
 (Red)	Solid - Printer head open, cutter error. Flash - Printing error, such as paper empty, paper jam, ribbon empty, or memory error etc.

■ Keypads

Keypad	Item name	Function
	Soft keys	The display will show the function for left and right key. The meaning of the soft keys will depend on the UI screen.
	Navigational keys	Select / Navigate.

■ Main Page Icon

Icon	Indication
	Wi-Fi device is ready (option).
	Ethernet is connected.
	Bluetooth device is ready (option).
	Remaining amount of ribbon (m).
	Security lock.
	Printhead cleaning notice.
	Reminds users to clean the printer when printing with the linerless media. (option)

Icon	Function
	Enter the printer setup menu.
	Calibrate the media sensor.
	Enter the “Favorites” option.
	<ul style="list-style-type: none"> ◆ Enter cursor (be marked in green) located option. ◆ Perform the function.
	Feed button (advance one label).
	Return to the previous level/step.
	Scroll up.
	Scroll down.

2.2.2 Touch Screen Manipulation

Tap an item to open/use it.

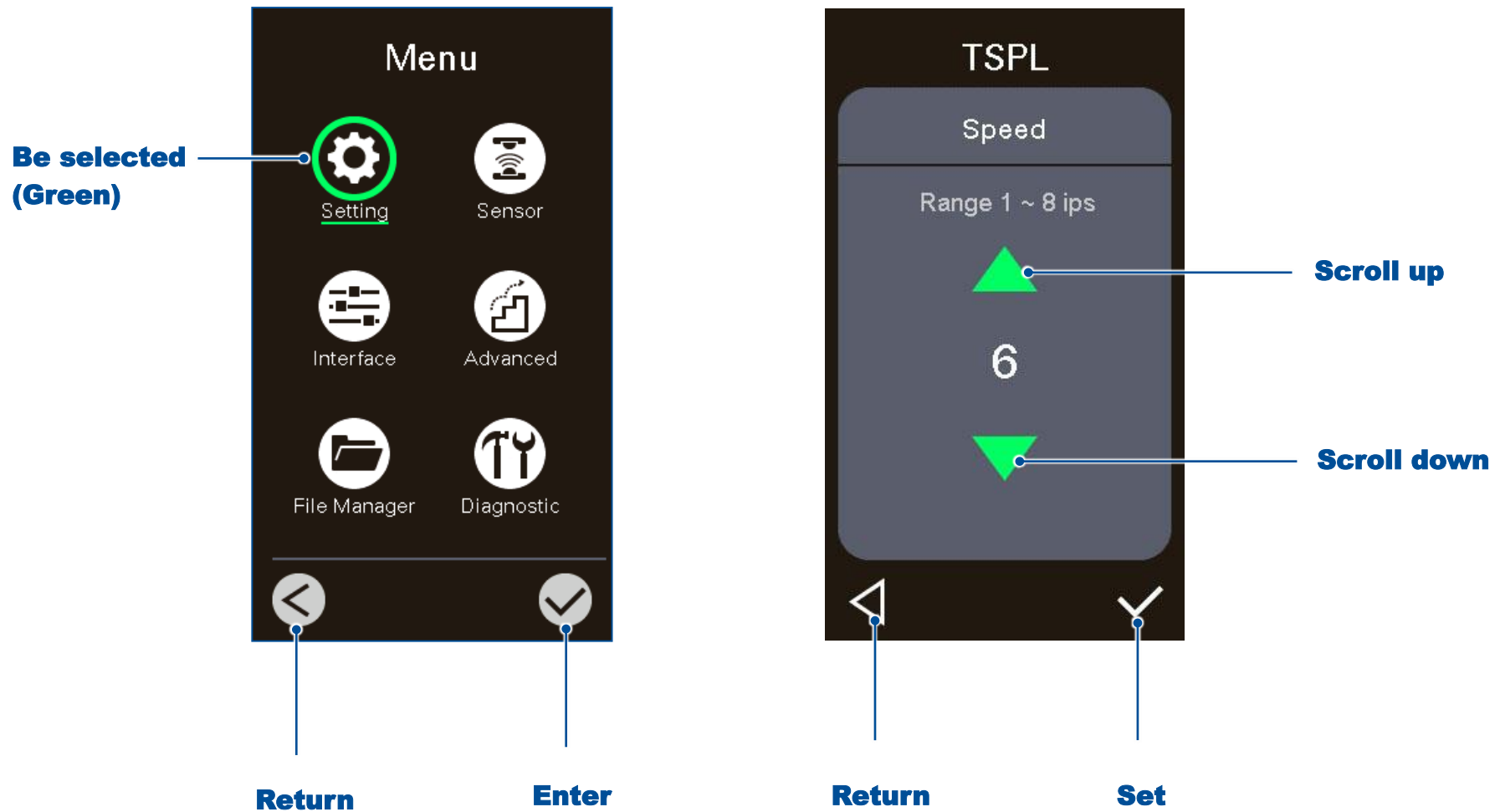

2.3 Power-on Utilities

Power-on Utilities provides the basic functions and can be activated by below procedures:

Turn off the power > **Hold** the button > **Open** the power > **Release** the button depending on the color of the LED.

Power down and hold the right side of the **Select Keys**  to restart the printer.

Sequences of the settings:

LED Colors Functions	Amber	Red (5 blinks)	Amber (5 blinks)	Green (5 blinks)	Green / Amber (5 blinks)	Red / Amber (5 blinks)	Solid green
1. Sensor Calibration (Gap / black mark sensor)		Release					
2. Self-Test (And enter dump mode)			Release				
3. Factory Default				Release			
4. Black Mark Calibration					Release		
5. Gap Calibration						Release	
6. READY (Skip AUTO.BAS)							Release

2.4 Web User Interface

Web User Interface enables users to control and manage the printer using a remote device over network.

2.4.1 Opening the Web User Interface

Follow the steps below to open the web user interface for the printer:

1. Make sure the printer is connected to the network and obtain the IP address.
Note: If the printer is connected to the network you can see the IP address on the LCD panel. For how to connect to the network, ask your IT staff or refer to the TSC Console (or Interface) section.
2. Open the browser on your computer.
3. Enter the printer's IP address inside the browser's address bar and then press "Enter".

NOTE:

- ◆ Due to regional regulations, users logging in for the first time in specific areas will be prompted to set a new user name and user password. When you log in for the first time, the printer prompts you to set a new user/administrator name and user/administrator password. Enter the user and administrator names and passwords. Then, enter "admin" in the current administrator password field and press the [Set] key to set. (User name & password: view the printer settings; Administrator name & password: set the printer settings)

TSC

Welcome to first time use

User Name

User Password

Administrator Name

Administrator Password

(Password length must be 8 to 15 characters, including one uppercase and lowercase letter and one number)

Enter the current administrator password

- ◆ The password setting rules are as follows: the length is limited to 8 to 15 characters, it must contain at least one uppercase and lowercase letter and a number. The content can be English letters, numbers, or symbols, but does not support double-byte characters.
- ◆ To consider security, the printer will restart if you enter an incorrect password 5 times.

4. When the following screen (Remote Panel) appears, you can start using the web user interface to manage the printer.

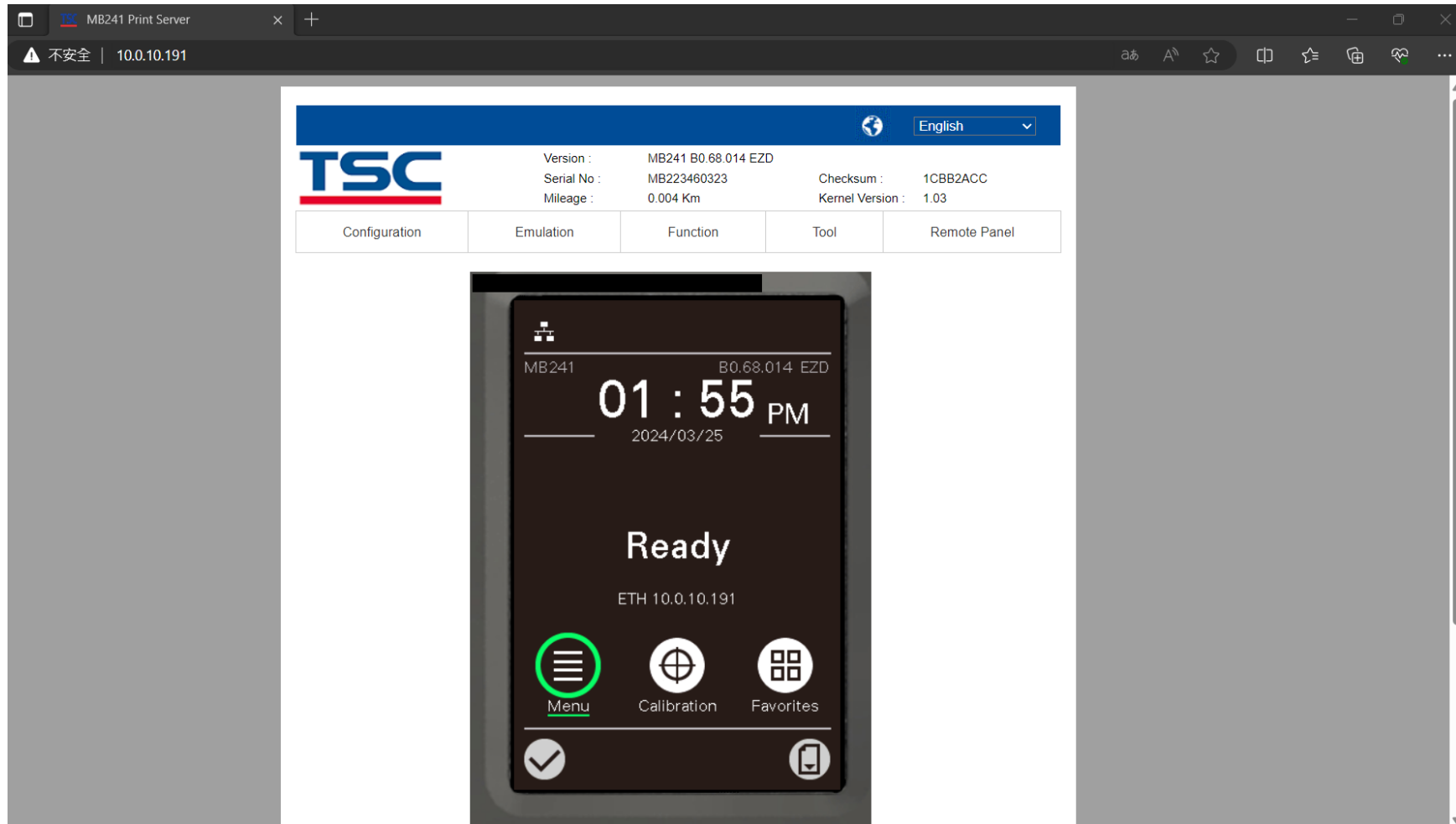

2.4.2 Introduction to Web User Interface

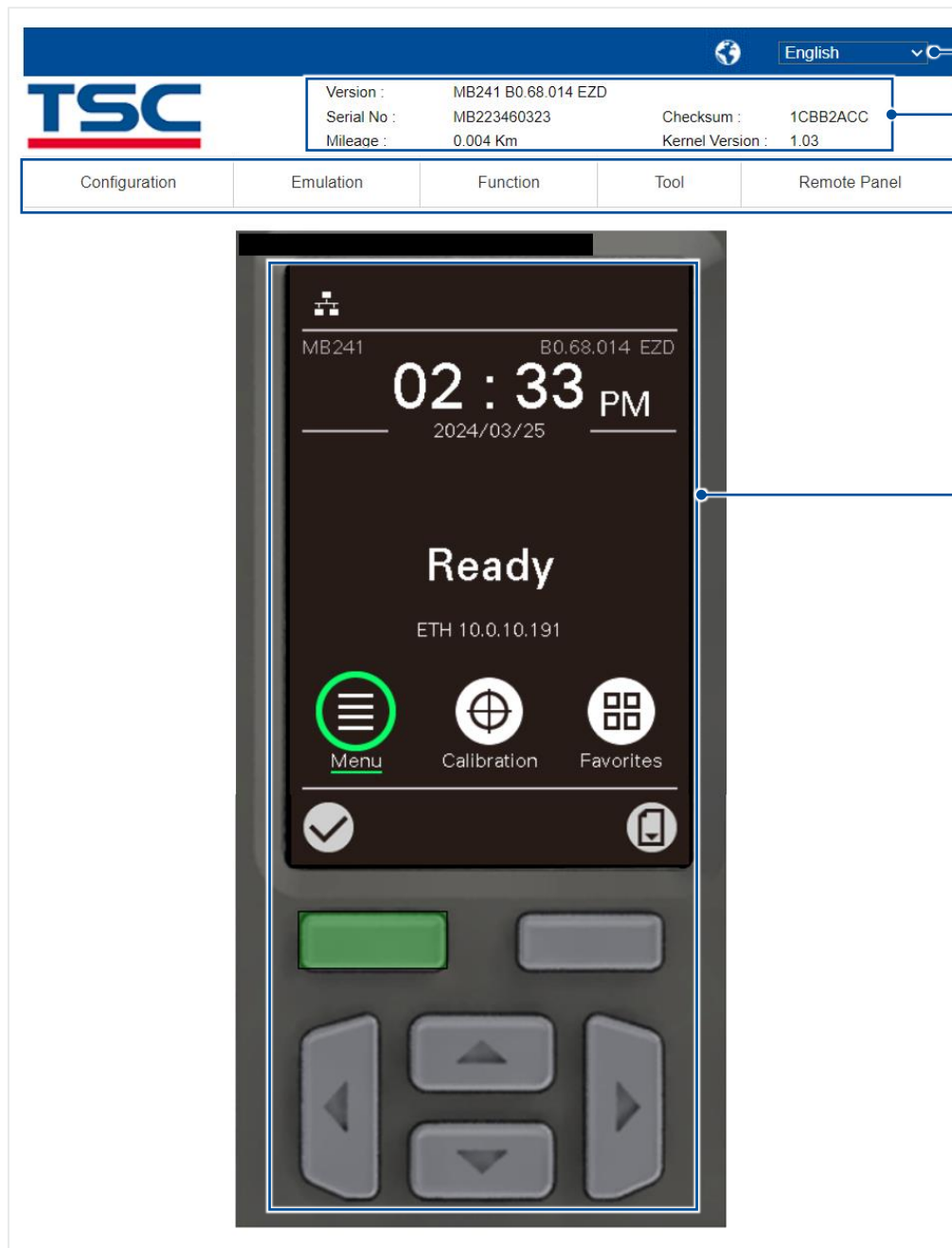

Language switching

Printer Model, Firmware Version, Serial Number etc.

Function menu bar
(see the following section for details)

Visualized Control Interface

The content you see here is exactly the same as what is displayed on the LCD screen of the actual printer, you can operate/setup the printer remotely directly from here.

Note:

- ◆ 3.5" touchscreen LCD panel allows mouse click operation directly on this LCD screen.
- ◆ 2.3" LCD panel can be operated by clicking the buttons below (mouse over the buttons and the screen will appear green).

For how to use the buttons and setting options on the control panel, you can refer to LCD Operator Control section.

2.4.3 Function menu

■ Configuration

Item		Description
Print	Common	Configures the printer using the TSPL command set. Refer to TSPL section for more information.
	Adjust	Adjusts the print and stop location. Refer to TSPL section for more information.
	Media	Configures the parameters that relate to the media type and sets the media sensor.
	Calibration	Configures the parameters that affect the media calibration.
RS232		Configures the settings for RS-232.
Bluetooth		Configures the settings for Bluetooth.
Ethernet		Configures the settings for Ethernet.
802.1X		Sets the 802.1X authentication.
Wi-Fi		Configures the settings for Wi-Fi.
Raw Port Filter		Configures the settings for RAW port filter.
RTC Setup		Sets the date and time for the printer.

■ Emulation

Item	Description
Z	Configures settings for the ZPL emulation
D	Configures settings for the DPL emulation

■ **Function**

Item	Description
SOTI settings	Sets the MQTT server and manages the CA certificate files.
TPH Care	Monitors the printhead's health status.
Email	Sets the SMTP server.
SNTP	Sets the SNTP server.
SNMP	Configures the SNMP (Simple Network Management Protocol) for the printer.
Web Password	Sets the user/administrator name and its corresponding password.
Log	Records the printer's activities.
Function	Provides quick access to the following functions: <ul style="list-style-type: none"> • Reset Printer • Configuration Page • Sensor Calibration • Factory Default • Ignore AUTO.BAS • Preferred Wi-Fi / Preferred Ethernet • Send File to Printer

■ **Tool**

Item	Description
File Manager	Manages the files saved in the built-in memory.
Communication Tool	Sends command sets or instructions to the printer.
Update Firmware	Updates the printer's firmware.
Clear Browsing Record	Clears the browsing record.
Classic Webpage	Switches to the classic user interface.

■ **Remote Panel**

This option returns you to the Visualization Control Interface page.

3. Setup

3.1 Setting up the Printer

1. Place the printer on a flat surface.
2. Make sure the printer is power off.
3. Connect the printer to the computer with the provided USB cable.
4. Plug in the power cord on the rear side of the printer.
5. Fully insert the power cord plug into the power outlet socket.

Note: Please switch OFF the printer before plugging in the power cord to printer power jack.

3.2 Loading the Ribbon



1. Open the media cover.



2. Slide the ribbon onto the ribbon supply spindle until it is flush with the flange.
3. Install the paper core onto the ribbon rewind spindle in the same way.

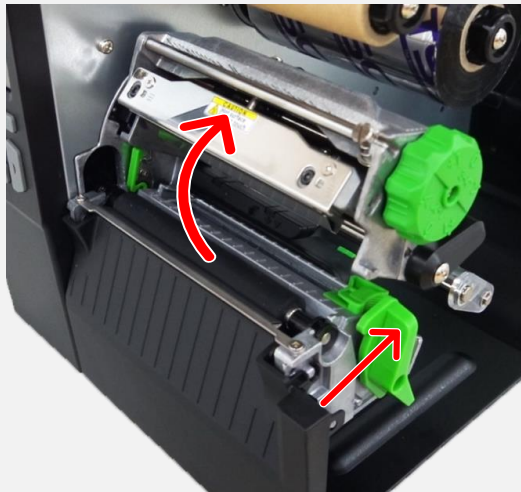

4. Release the lever to open the printhead.



5. Thread the ribbon through the open space between printhead and platen roller. Then pull the ribbon onto the paper core.



6. Wrap the ribbon onto the rewind spindle. Keep the ribbon flat and without wrinkles.
7. Wind the ribbon clockwise about 3~5 turns onto the ribbon take-up spindle until it is smooth and properly stretched tight.

Ribbon Loading Path

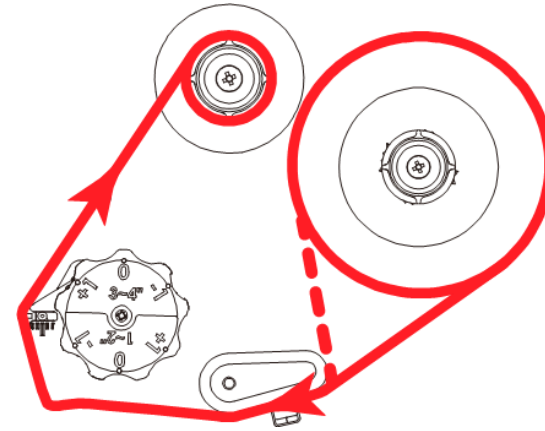

- Ink coated outside**
- - - - - Ink coated inside**

3.3 Loading the Media



1. Open the media cover.



2. Slide the label roll guard to the end of the spindle then flip it down.



3. Place media roll on the label supply spindle (with 3" core adapters) and push it to the end of the spindle.



4. Flip the label roll guard up and push it to fit the width of label roll.

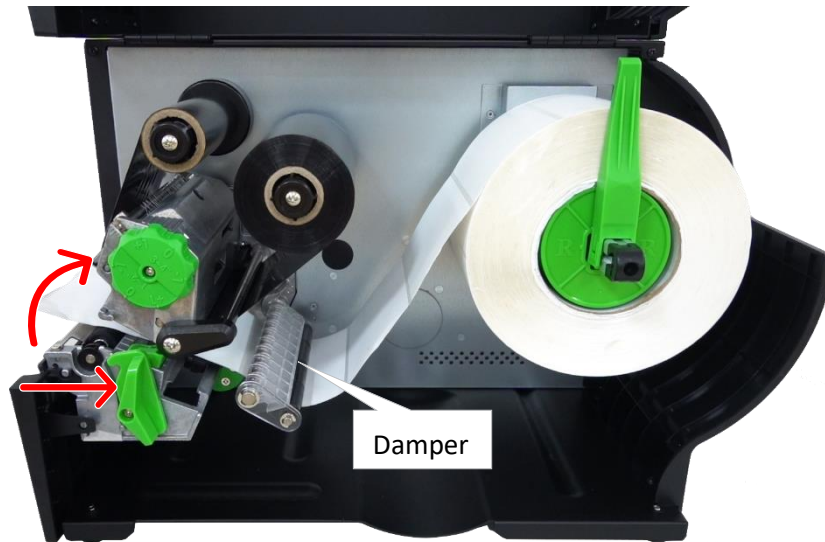

- Release the lever to open the printhead.
Thread the label through the damper, media sensor, and label guide.

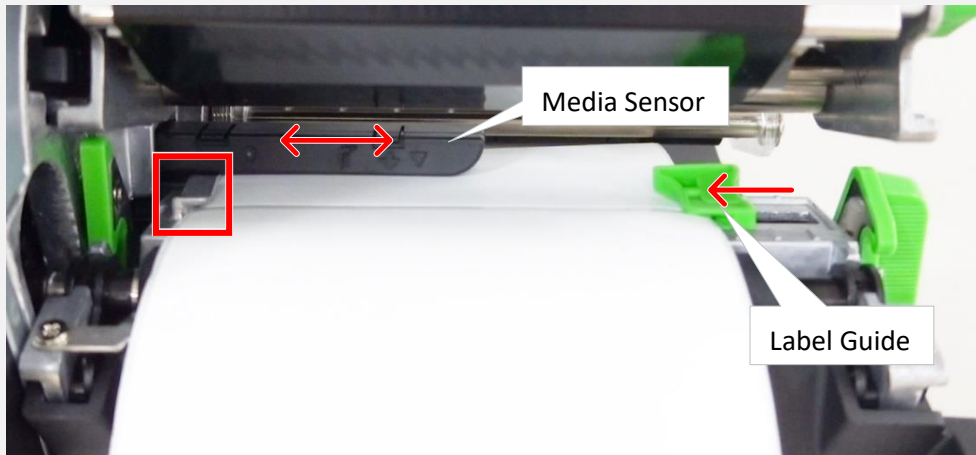
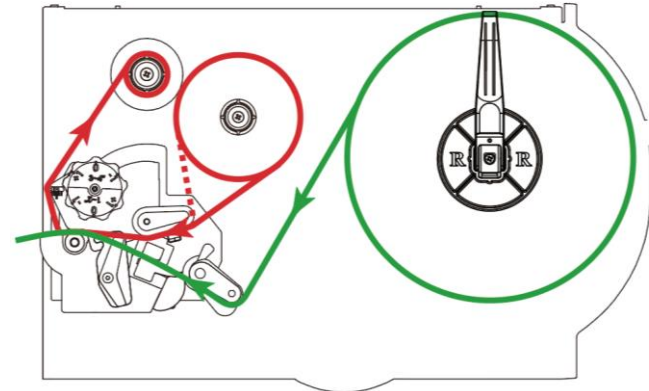

- Adjust the position of the media sensor.
- Adjust the label guide to fix the media position.
- Close the printhead ensuring that the printhead is correctly locked by the printhead release lever.

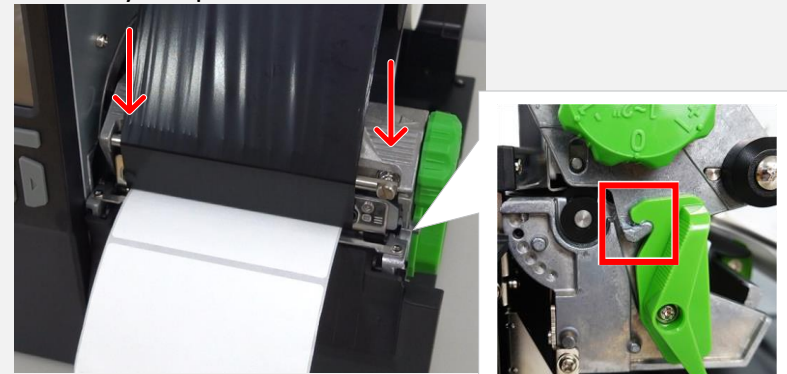

- Using the front display panel to perform a calibration for the media in use. For touch LCD, press  icon to calibrate the sensor. For 2.3" LCD, refer to [Sensor](#) section for more information.

3.4 Loading the Fanfold/External Media



- 1. Open the media cover.
- 2. Insert the fanfold media through the rear external label entrance chute.

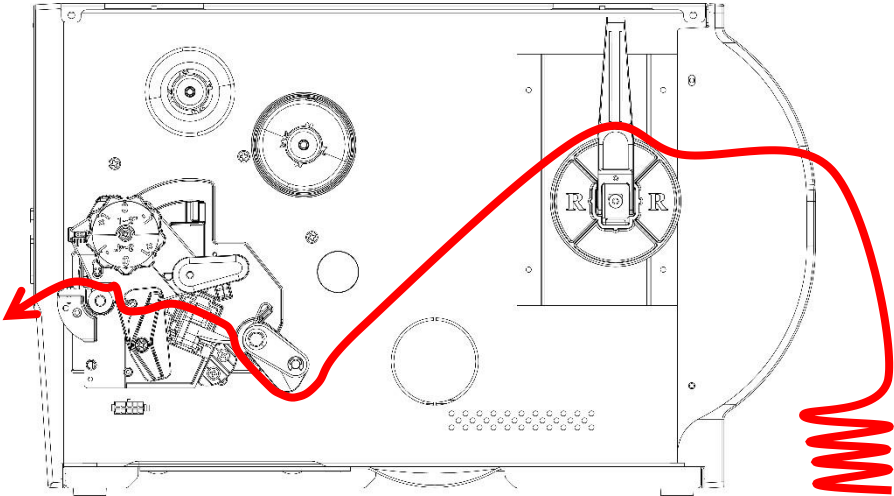

- 3. Refer [Loading the Media](#) section to load the media.

3.5 Loading the Media in Peel-off Mode (Optional)



1. Open the media cover and load the media.
2. Release the lever to open the printhead.

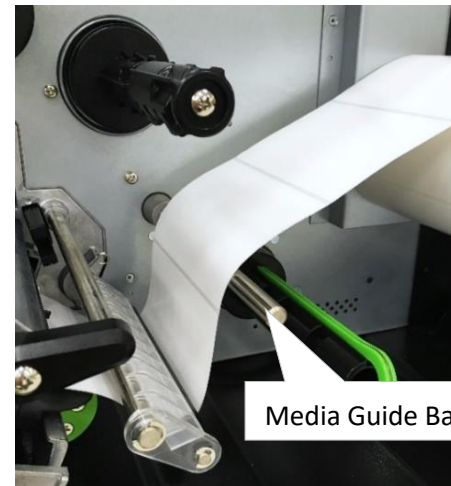

3. Install the label as indicated. (Pass the label over the top of guide bar and under the damper, through media sensor, and label guide.)

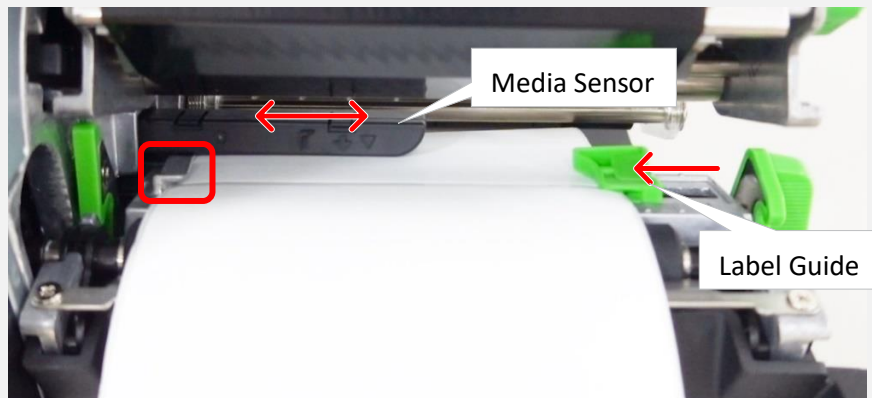

4. Adjust the position of the media sensor and the label guide to fix the media position.
5. Close the printhead. Using the front display panel to perform a calibration for the media first. For touch LCD, press  icon to calibrate the sensor. For 2.3" LCD, refer to [Sensor](#) section for more information.

Note:

Calibrate the sensor before loading the media in the peel-off mode to avoid the paper jam.

6. Set the print mode to the **Peeler Mode**. Refer to [Setting](#) section. (Setting > Print Mode)

Note:

The Print Mode can also be set through the Driver or the TSC Console.

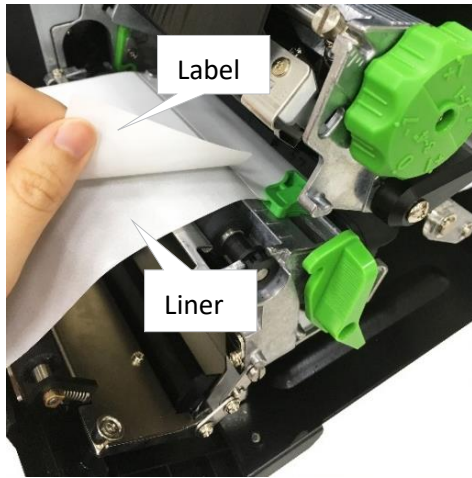

7. Release the lever to open the printhead after calibrating. Release peel-off module lever.
8. Pull the label out about 650mm and peel off a few labels, leaving the liner.

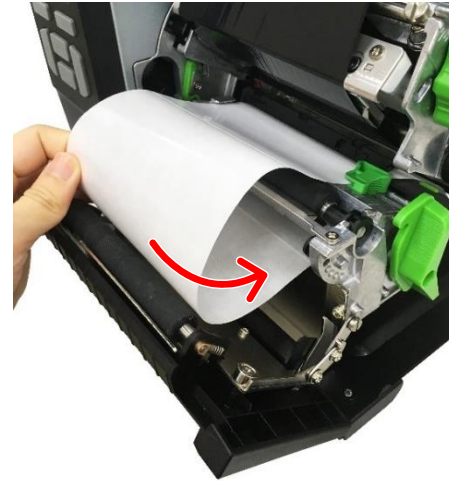

9. Feed the leading edge of liner through the peel-off module slot as indicated.



10. Pull out the securing clip (green). Wind the liner onto the spindle until the liner stretched properly.
11. Insert the securing clip to secure the liner.



Note:
The liner can also be secured onto the rewind spindle with the paper core.

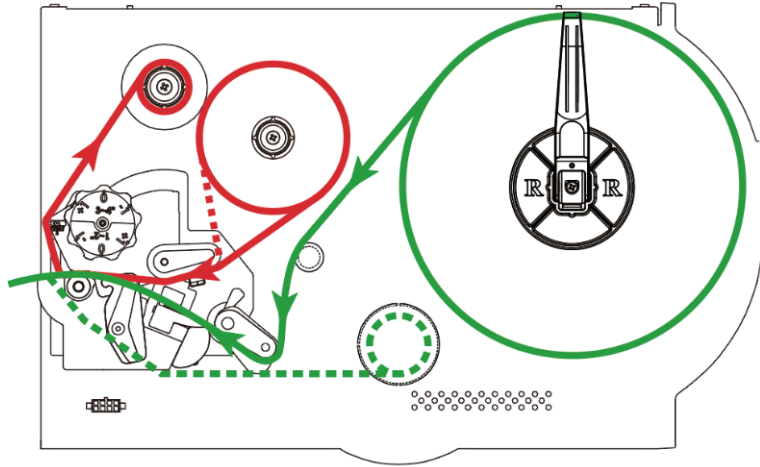

12. Close the peel-off module and the printhead.
13. Press the FEED button to test the operation of the peeler.

—— Label with liner
- - - Liner

3.6 Loading the Media in Cutter Mode (Optional)

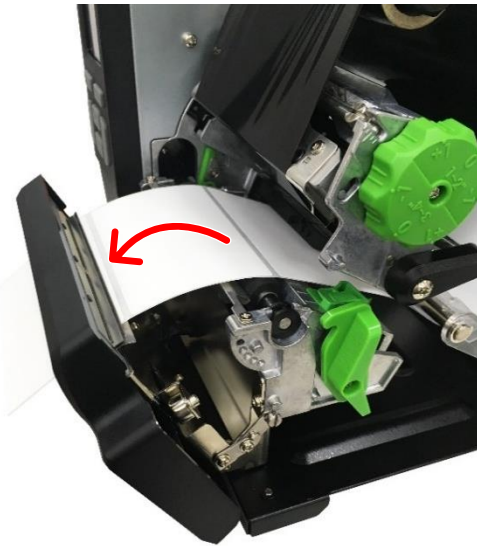

1. Open the media cover, the printhead, and the cutter module.
2. Refer to [Loading the Media](#) section to load the media and make it under go through the cutter paper entrance.



3. Close the printhead and the cutter module.

4. Using the front display panel to perform a calibration for the media.



For touch LCD, press  icon to calibrate the sensor.
For 2.3" LCD, refer to [Sensor](#) section for more information.

5. Set the print mode to the **Cutter Mode**.
Refer to [Setting](#) section. (Setting > Print Mode)

Note:

[The Print Mode can also be set through the Driver or the TSC Console.](#)

6. Press the FEED button to test the operation of the cutter.

3.7 Loading the Linerless Media (Optional)



1. Open the media cover and the printhead.



2. Open the upper bar for the linerless cutter (or tear) module gate.

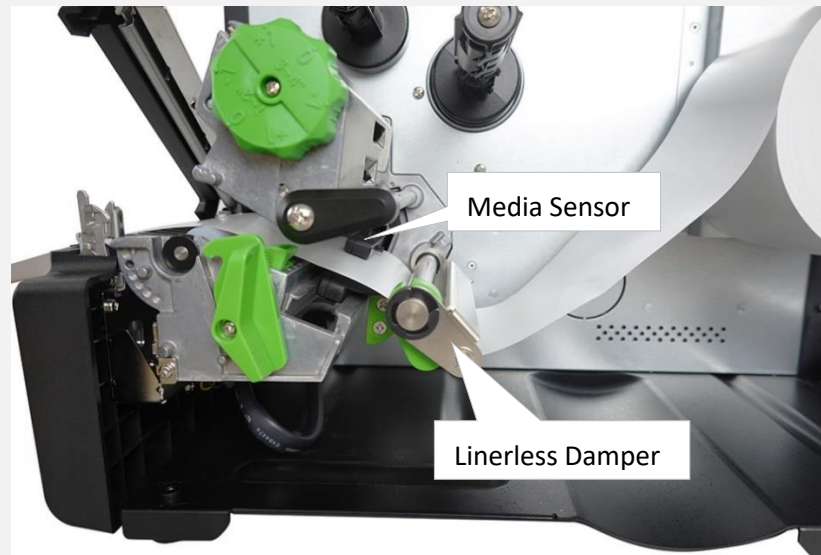

3. Refer to [Loading the Media](#) section to thread the media under the damper, through the media sensor and under the printhead. Keep feeding the media until the media extends out of the front side of the linerless cutter (or tear) module.



4. Align the media with the media guide ensuring that the media is threaded under the guide.



5. Adjust the media guide ensuring that the location of the guide fits with the media's width.

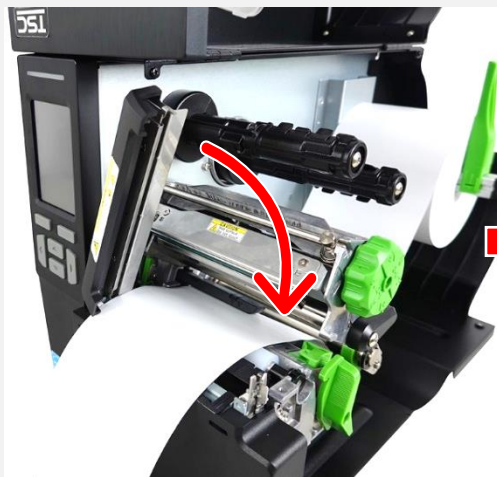
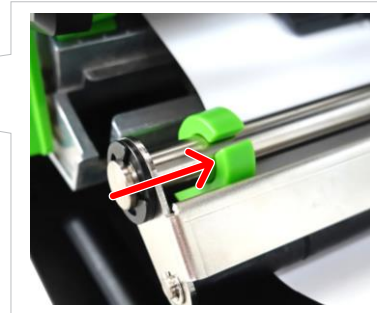

6. Close the upper bar for the linerless cutter (or tear) gate.
7. Close the printhead ensuring that the printhead is correctly locked by the printhead release lever.
8. Close the media cover.
9. Refer to [Configuring the Printer and Setting Options for the Linerless Media](#) section to setting the linerless printer.

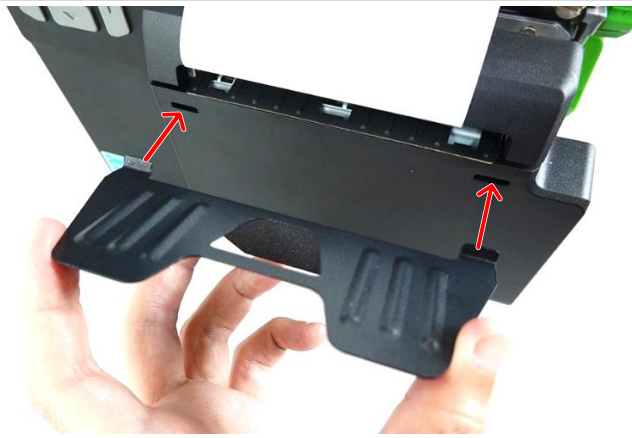

10. (For cutter module only) Insert the ribs on the label tray into its corresponding opening on the front panel of the cutter module.

- The images below demonstrate the two printers shipped with cutter module and tear module respectively.

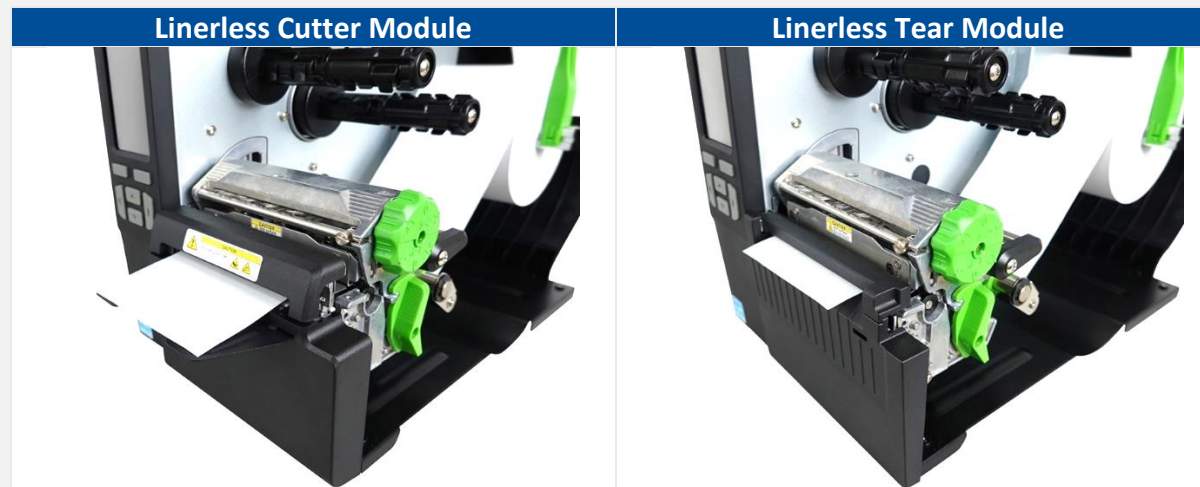

Note:

The loading media for linerless tear and linerless cutter modules are in the same way, this section mainly demonstrates the Linerless Cutter Module as an example.

4. Knob Adjustment

4.1 Printhead Pressure Adjustment Knob

Printhead Pressure Adjustment Knob has 6 levels' adjustment for 1" to 2" and 3" to 4" width media.

Different number means different pressure to the media. Due to printer's paper alignment is on left side of the mechanism, different media width requires the different pressure. Users can try which level can meet their expectation.

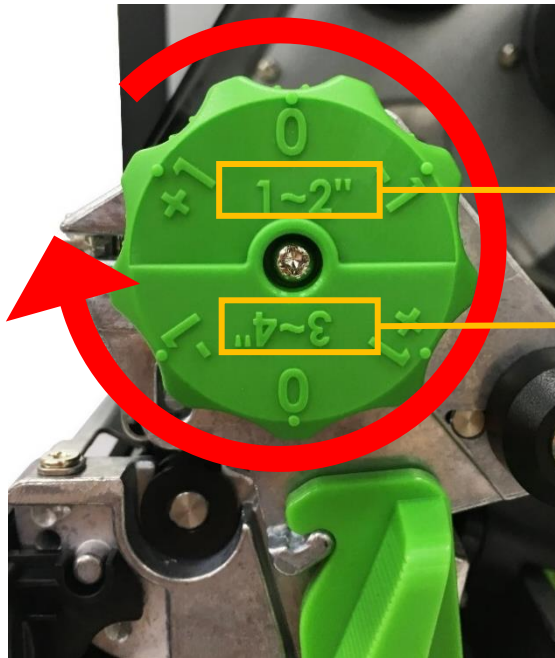

Print Head Pressure Adjustment range
from 1~2" media width

Printhead Pressure Adjustment range
from 3" to 4" media width

- **0** means regular media thickness (0.14-0.16mm) pressure setting.
- **-1** means lower pressure for thin paper media
- **+1** means higher pressure for thick media

4.2 Ribbon Tension Adjustment Knob

Ribbon Tension Adjustment Knob has 5 positions for adjustment. Due to the ribbon is aligned to the inbound of print mechanism, different width of ribbon may need to adjust the tension adjustment knob to avoid the ribbon wrinkle and get the best print quality. Refer to [Mechanism Fine Adjustment to Avoid Ribbon Wrinkles](#) section for how to adjust.

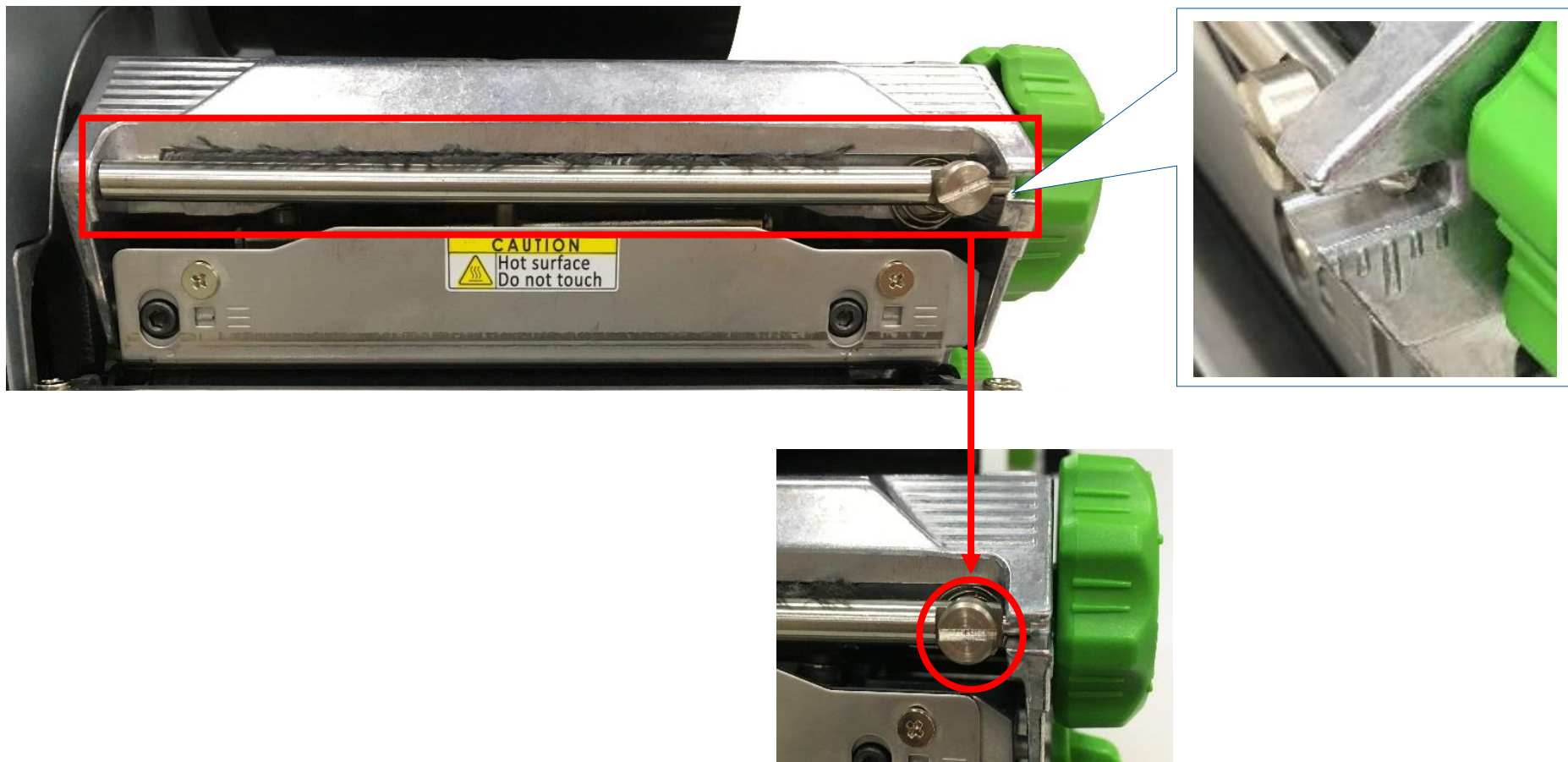

4.3 Mechanism Fine Adjustment to Avoid Ribbon Wrinkles

Ribbon wrinkle is related to the media width, thickness, printhead pressure balance, ribbon film characteristics, print darkness setting...etc. In case the ribbon wrinkle happens, please follow the instructions below to adjust the printer parts.

Ribbon Tension Adjustment Knob has 5 indexes for adjustment. Use flat screw driver to change the ribbon tension.

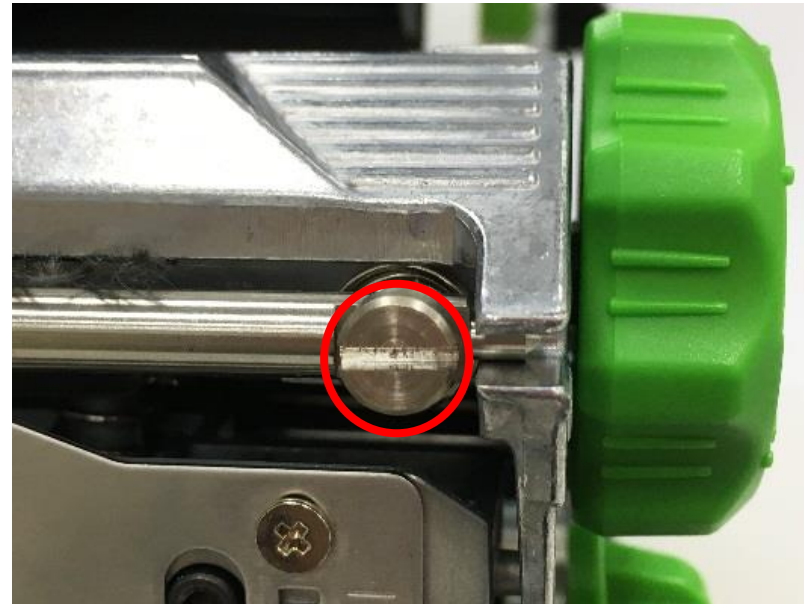

Wrinkle happens from label lower right to upper left direction

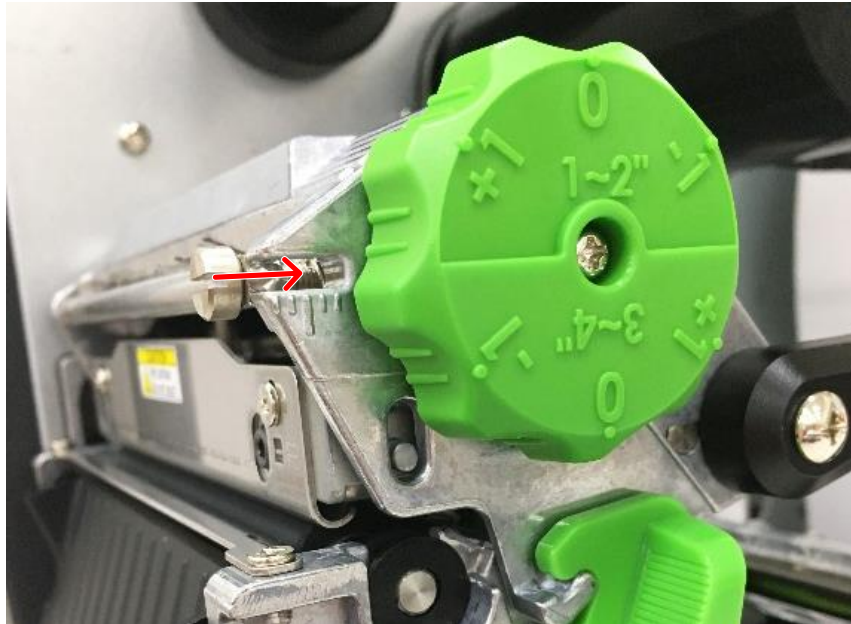

- Make sure the Printhead Pressure Adjustment Knob (green) is in correct position for the current media width. (1 to 2" or 3 to 4")
- Turn the screw clockwise per level and print to see if the wrinkle has gone.
- If the ribbon tension adjustment knob has positioned on the level of innermost side but the ribbon wrinkle cannot be removed, please switch the printhead pressure (green) at 1 level and print the label again to check if the wrinkle is gone.
- If the wrinkle can't be avoided, please contact the Customer Service Department of your purchased reseller or distributor for service.

Wrinkle happens from label lower left to upper right direction



- Make sure the Printhead Pressure Adjustment Knob (green) is in correct position for the current media width. (1" to 2" or 3" to 4")
- Turn the screw counterclockwise per level and print to see if the wrinkle has gone.
- If the ribbon tension adjustment knob has positioned on the level of outermost side but the ribbon wrinkle cannot be removed, please switch the printhead pressure (green) at 1 level and print the label again to check if the wrinkle is gone.
- If the wrinkle can't be avoided, please contact the Customer Service Department of your purchased reseller or distributor for service.

5. TSC Console

TSC Console is a management tool combining the Printer Management, Diagnostic Tool, CommTool and Printer Webpage settings, which enables you to adjust printer's settings/status; change printers' settings; download graphics, deploy fonts, graphics, label templates or upgrade the firmware to the group of printers, and send additional commands to printers at the same time.

5.1 Start TSC Console

1. Double click TSC Console icon to start the software.

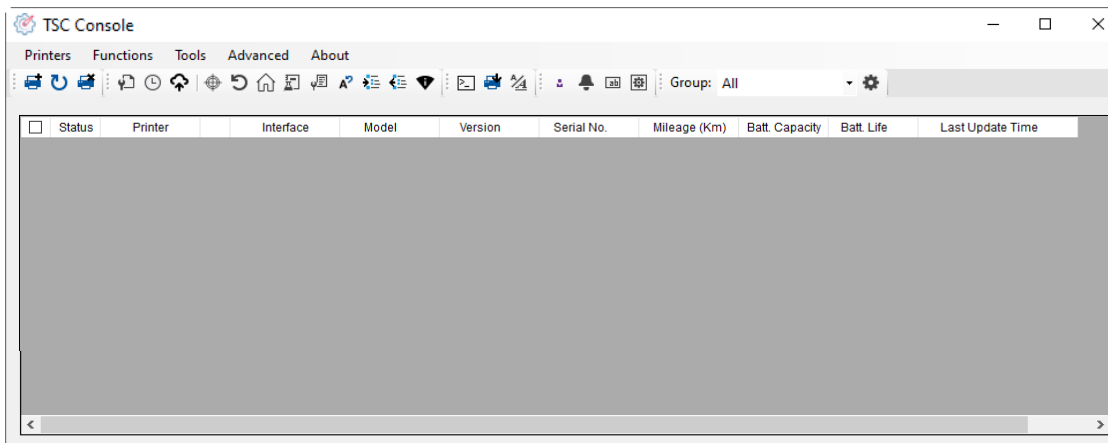

2. Manually add the devices by clicking **Printer > Add Printers**.

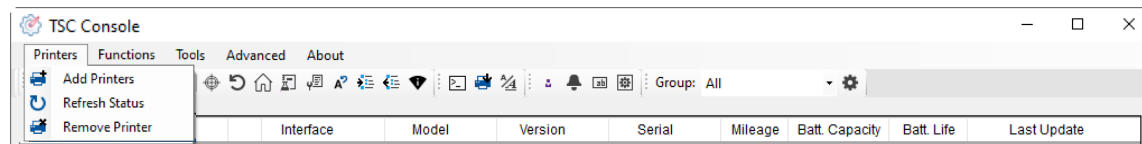

3. Select the current interface of the printer.

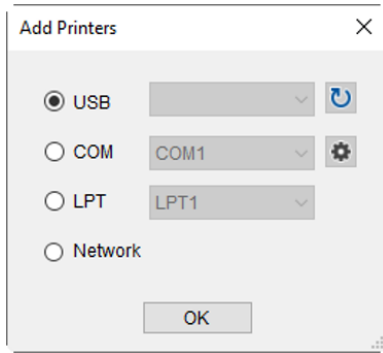

4. The printer will be added to **TSC Console**'s interface.

5. Select the printer and set the settings.

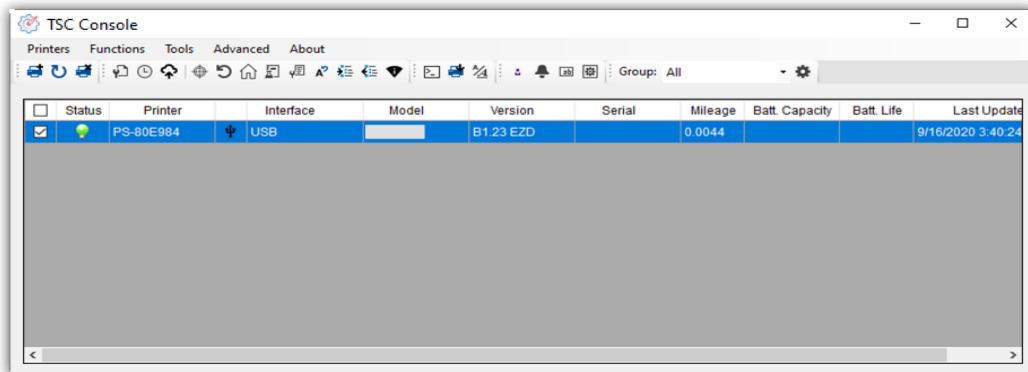

■ For more information, please refer to [TSC Console User Manual](#).

5.2 Set Ethernet and Add to TSC Console Interface

- Use **USB** or **COM** to establish the interface on **TSC Console**. Refer to [Start TSC Console](#) section.

Status	Printer	Interface	Model	Version	Serial No.	Mileage (Km)	Batt. Capacity	Batt. Life	Last Update Time
<input checked="" type="checkbox"/>	PS-E0122A	USB			MH59280311	0.2791			08/10/2021 15:11:24

- Double click to enter the **Printer Configuration Page** > Click **Ethernet** tab > Set the **Ethernet** > When the setting is complete, click the **Set** button on the right. (For DHCP, press the **Get** button to check the **IP Address** after setup, or check on the printer LCD control panel.)

Note:

If you are connected to Wi-Fi network before, you have to switch to Ethernet via LCD menu. Refer to [Ethernet](#) section.

The screenshot shows the 'Printer Configuration' dialog box with the 'Ethernet' tab selected. The 'DHCP' radio button is selected, and the IP address is set to 10.0.10.181. The Subnet Mask is 255.255.255.0, the Gateway is 10.0.10.251, and the MAC Address is 00-1B-82-E0-12-2A. The Printer Name is PS-E0122A and the Raw Port is 9100. A red box highlights the DHCP settings and the 'Set' button. A red arrow points from the 'Ethernet' tab in the left pane to the DHCP settings in the right pane.

- Return to **TSC Console** main page > Click **Add Printer** on the top left of the window.

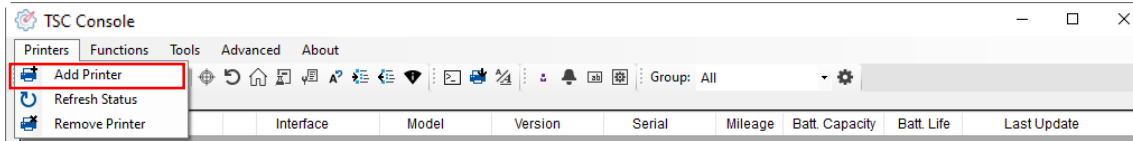

- Choose **Network** > Key in the **IP Address** > Click **Discover** to establish the Ethernet interface.

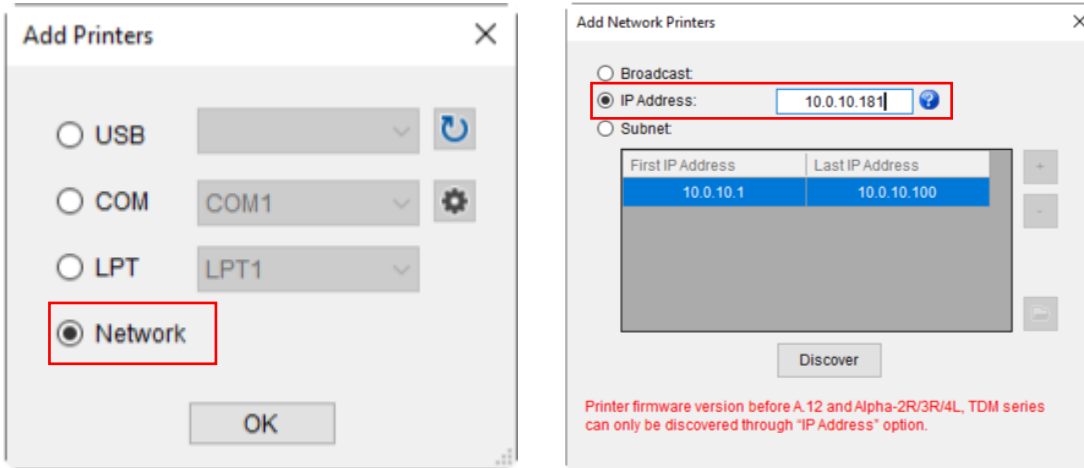

- If the connection is successful, the Add Printer window will pop up > Click **OK** to close the window > The **TSC Console** will appear for printer that use the Ethernet interface.

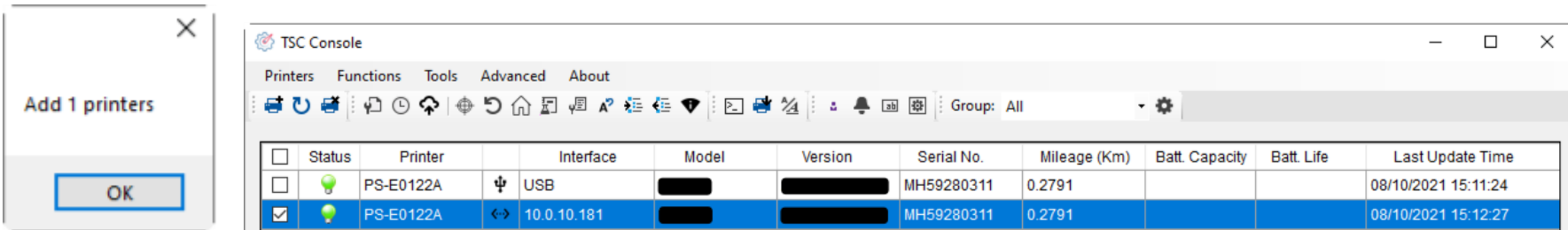

5.3 Set Wi-Fi and Add to TSC Console Interface

- Use **USB** or **COM Port** to set up the interface. Refer to [Start TSC Console](#) section.
- Double click to enter the printer configuration page.

Note:

If you are connected to **Wi-Fi** network before, you have to switch to **Wi-Fi** via LCD menu. Refer to [Wi-Fi](#) section.

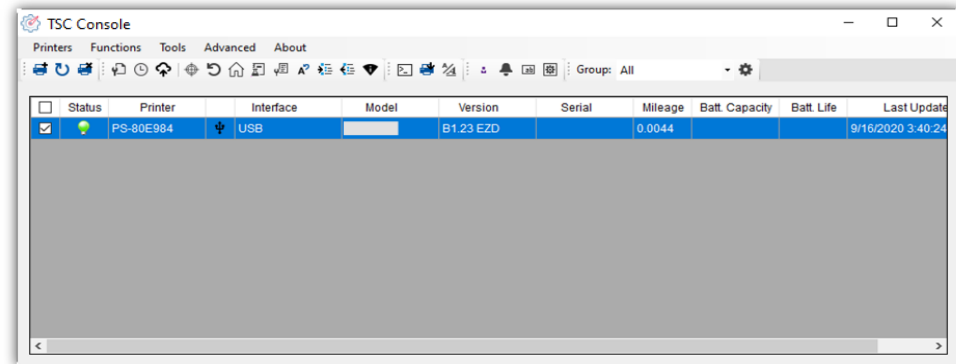

- Click **Get** to receive printer's information.
- Click **Wi-Fi** to the wi-fi setting page.

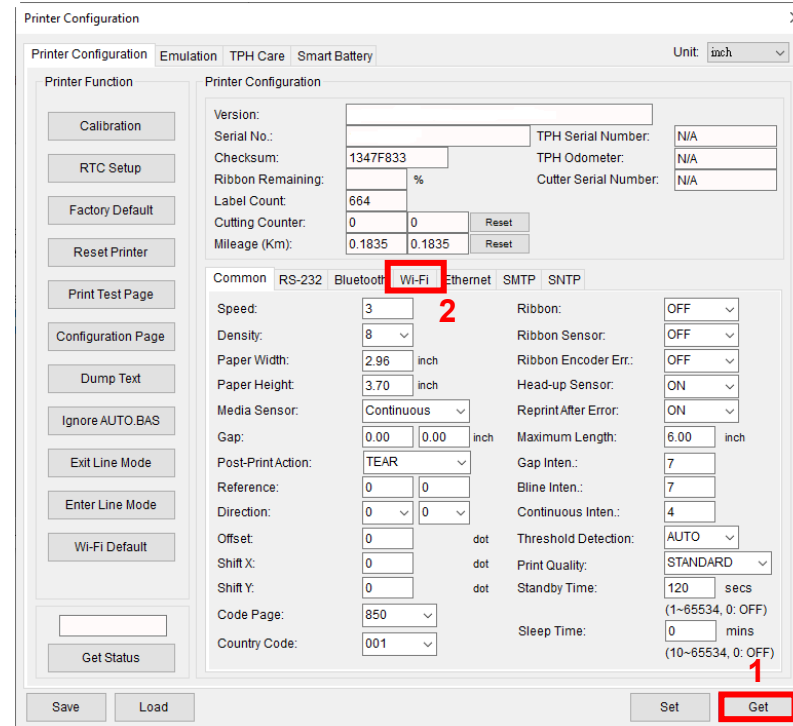

For WPA-Personal

- I. Fill-in the **SSID**.
- II. Select the Encryption option to **WPA-Personal**.
- III. Fill-in the Key.
- IV. Select **DHCP** to **ON**. (For **OFF** option, please fill-in the IP Address, Subnet Mask and Gateway)
- V. After setting, click the **Set** button.

Note:

Before setting, the entered field will be shown in yellow for reminding. On DHCP, user can change the printer name by another model name in "Printer Name" field.

User also can change the raw port in "Raw Port" field.

Common RS-232 Bluetooth Wi-Fi Ethernet SMTP SNTP

Built-in Wi-Fi Module

SSID: SSID_1

WLAN Encryption: WPA-Personal

Key: *****

DHCP: ON

IP Address: []

Subnet Mask: 0.0.0.0

Gateway: []

Primary DNS IP: []

Secondary DNS IP: []

Raw Port: 9100

Printer Name: PS-FF153C

MAC Address: 00:1B:82:FF:15:3C

EAP Type: []

Username: []

Password: []

CA Certificate: []

Client Certificate: []

Private Key: []

EAP-FAST PAC: []

File Name Browse

Wi-Fi Version: 3.7.1.0R6

RSSI: 0

Set Get

For WPA-Enterprise

- I. Fill-in the **SSID**.
- II. Select the Encryption option to **WPA-Enterprise**.
- III. Select DHCP to **ON** (For **OFF** option, please fill-in the IP Address, Subnet Mask and Gateway)
- IV. Select the **EAP Type** option. (For **EAP-TLS** option, please upload the CA and Key for mutual authentication, integrity-protected cipher suite negotiation, and key exchange between two endpoints.)
- V. After setting, click the **Set** button.

Note:

Before setting, the entered field will be shown in yellow for reminding. On DHCP, user can change the printer name by another model name in "Printer Name" field.

User also can change the raw port in "Raw Port" field.

Common RS-232 Bluetooth Wi-Fi Ethernet SMTP SNTP

Built-in Wi-Fi Module

SSID: SSID_2

WLAN Encryption: WPA-Enterprise

Key: *****

DHCP: ON

IP Address: []

Subnet Mask: 0.0.0.0

Gateway: []

Primary DNS IP: []

Secondary DNS IP: []

Raw Port: 9100

Printer Name: PS-FF153C

MAC Address: 00:1B:82:FF:15:3C

EAP Type: []

Username: []

Password: []

CA Certificate: []

Client Certificate: []

Private Key: []

EAP-FAST PAC: []

File Name Browse

Wi-Fi Version: 3.7.1.0R6

RSSI: 0

Set Get

- After clicking **Set** button, it'll pop-up the window tip as below shown.

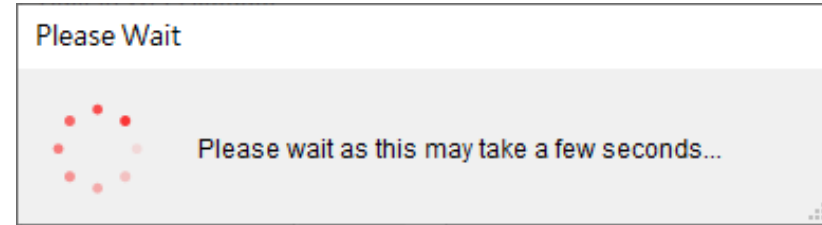

- IP address will be shown in the "IP address" field and the Wi-Fi logo and IP address will be displayed on the LCD control panel.

Note:

IP address should be shown within about 5 to 15 seconds after printer turn on. If not, please refer to steps below to initialize the printer Wi-Fi module settings then to setup it again.

- Remove the cable between the computer and the printer.
- Go to main page, click **Add Printer** to add the printer via **Network**.
- Select the printer and enter the setting page by double clicking the printer.
- Click the **Print Test Page** button to print the test page via Wi-Fi interface.

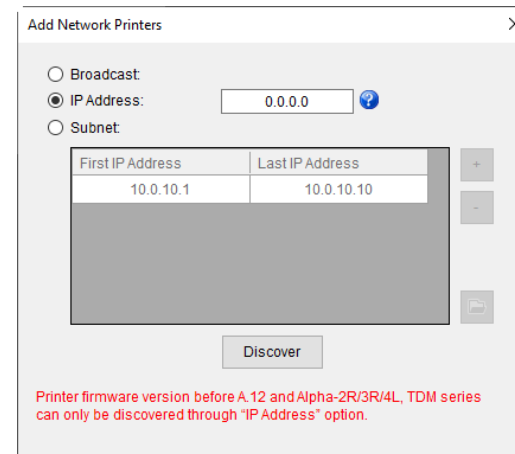

5.4 Initialize the Printer Wi-Fi Setting

1. Return to the main page of TSC Console. Select the printer and click **Functions** to expand the page.

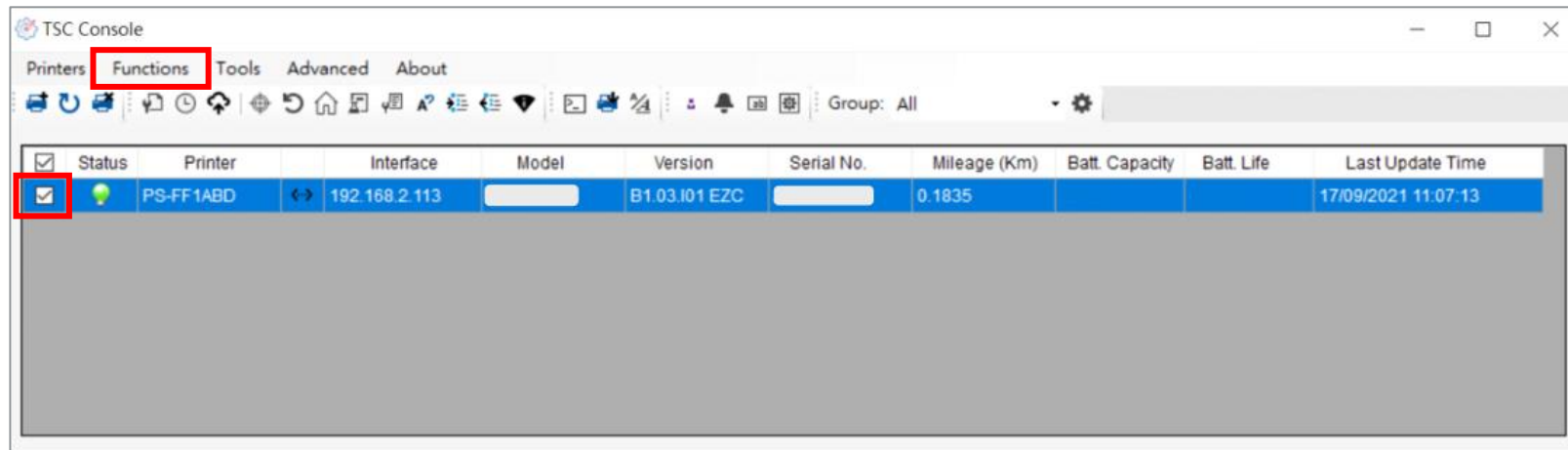

2. Click **Wi-Fi Default** to initialize the printer Wi-Fi module setting to factory default setting.

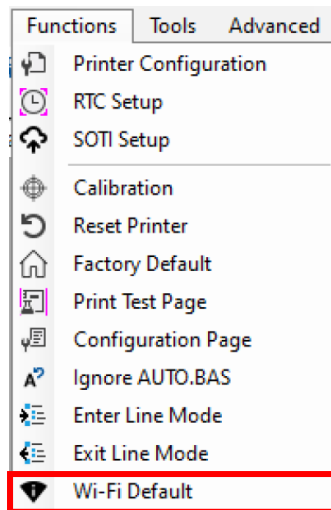

5.5 Printer Function

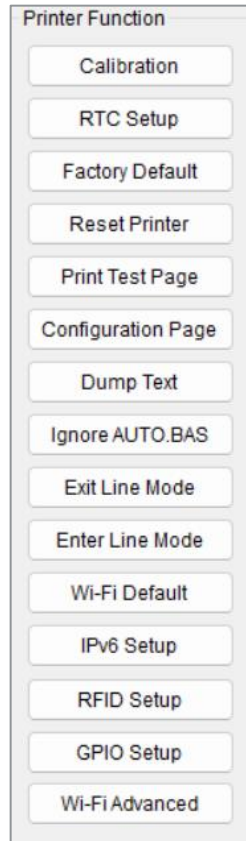

Printer Function could be found in Printer Configuration. “Printer Function” will be shown on the left side of the window.



Functions	Description
Calibrate	Detect media types and the size of the label
RTC Setup	Synchronize printer with Real Time Clock on PC
Factory Default	Initialize the printer to default settings
Reset Printer	Reboot printer
Print Test Page	Print test page according to the specified label size and sensor type.
Configuration Page	Print printer configurations
Dump Text	Activate the printer to dump mode
Ignore AUTO.BAS	Ignore AUTO.BAS file when printer boot up
Exit Line Mode	Exit the line mode to page mode
Enter Line Mode	Leave page mode and enter line mode
Wi-Fi Default	Restore the Wi-Fi settings to defaults.
IPv6 Setup	Enter the IPv6 settings window to configure the settings
RFID Setup	Enter the RFID settings window to configure the settings
GPIO Setup	Enter the GPIO settings window to configure the settings
Wi-Fi Advanced	Enter the Wi-Fi module's Advanced Settings window to configure the settings



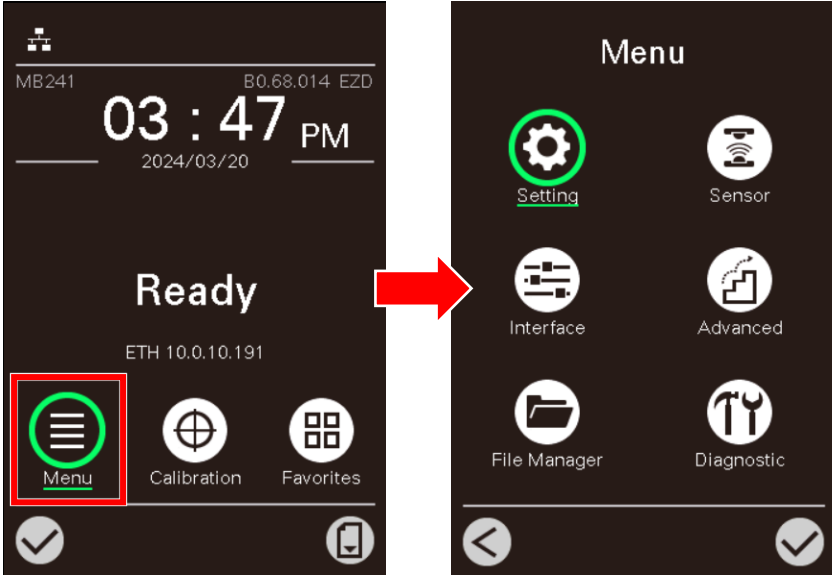

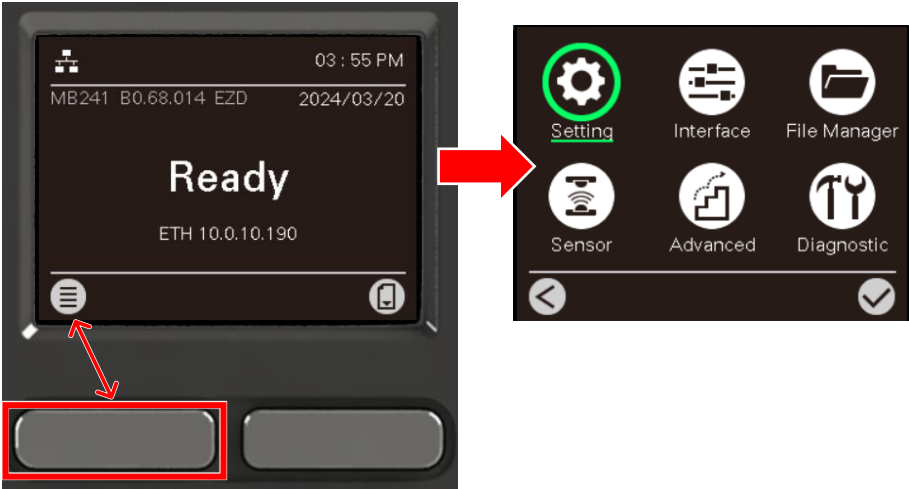

6. LCD Menu Function

6.1 Enter the Menu

Touch Display	2.3" Display
<p>Tap the  (Menu) icon on LCD main page to enter the menu.</p> 	<p>Press the left soft key to enter the  to enter the menu.</p> 

6.2 Menu Overview

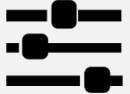
There are 6 categories on the menu. Users can easily set the settings of the printer without connecting the computer. Please refer to following sections for more details.

 <p>Setting To set up the printer settings for TSPL & ZPL2.</p>	 <p>Advanced To set LCD, initialization, cutter type,...etc.</p>
 <p>Sensor To calibrate the selected media sensor.</p>	 <p>File Manager To check and manage printer's memory storage.</p>
 <p>Interface To set the printer interface settings.</p>	 <p>Diagnostic To check printer and help users to troubleshoot the problems.</p>

6.3 Setting

It allows users to configure the printer using the TSPL or ZPL2 command set.

NOTE: TSPL indicates TSC printer language and ZPL2 indicates an emulation of Zebra printer language.

Tap the **Command Set** on LCD to switch between TSPL and ZPL2.

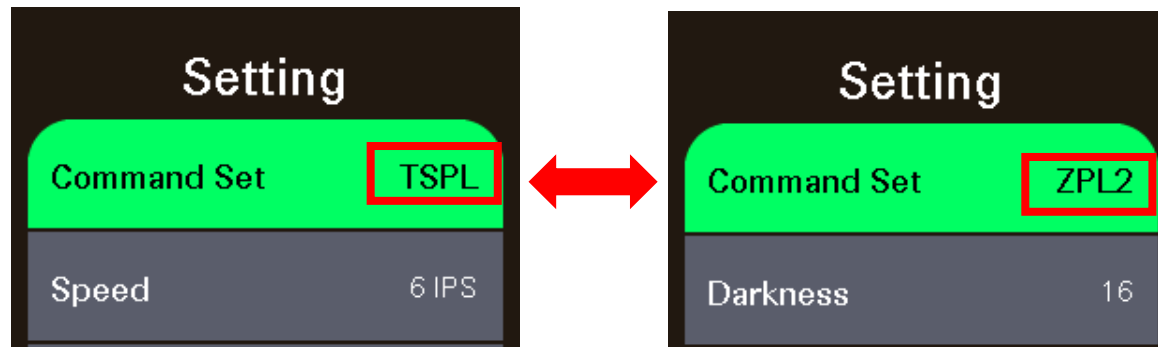

For 2.3" display, **Command Set** can be activated by **Navigational Keys**.

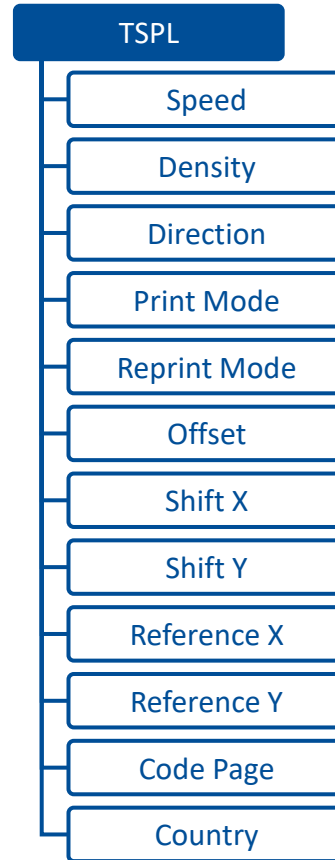

6.3.1 TSPL

The following illustration and table describe the TSPL command set.

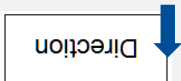
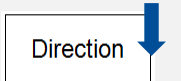

Item	Description	Default
Speed	Set the print speed. Setting range: 1 to 10 for 203dpi; 1 to 7 for 300dpi.	203 dpi: 5 300 dpi: 3
Density	Set printing darkness. Setting range: 0 to 15, and the step is 1.	8
Direction	Set the printout direction. Setting Value: 0 and 1. (Feed direction ↓) Direction 0:  Direction 1: 	0
Print mode	Set the print mode. There are 6 modes in total: <ul style="list-style-type: none"> • None: Next label top of form is aligned to the printhead burn line location. (Tear Off Mode) • Batch Mode: Once finishing the printing process, label will be fed to the tear plate location. • Peeler Mode: Enable the label peel off mode. • Cutter Mode: Enable the label cutter mode. • Cutter Batch: Cut the label once at the end of the printing job. • Rewinder Mode: Enable the label rewinder mode. 	Batch Mode
Reprint Mode	Enables/Disables reprint mode. When set to enable, you can reprint the last label printed by pressing the up arrow key. ()	Disable
Offset	Adjust media stop location. Available value setting range: -999 dots to 999 dots.	0 dot
Shift X	Adjust print position. Available value setting range: -999 dots to 999 dots.	0 dot
Shift Y		0 dot
Reference X	Set the origin of printer coordinate system horizontally and vertically. Available setting range: 0 dot to 999 dots.	0 dot
Reference Y		0 dot
Code page	Set the code page of international character set.	850
Country	Set the country code. Available setting value range: 1 to 358.	001

Note: If printing from enclosed software/driver, the software/driver will send out the commands, which will overwrite the settings set from the panel.

6.3.2 ZPL2

This “ZPL2” category can set up the printer settings for ZPL2.

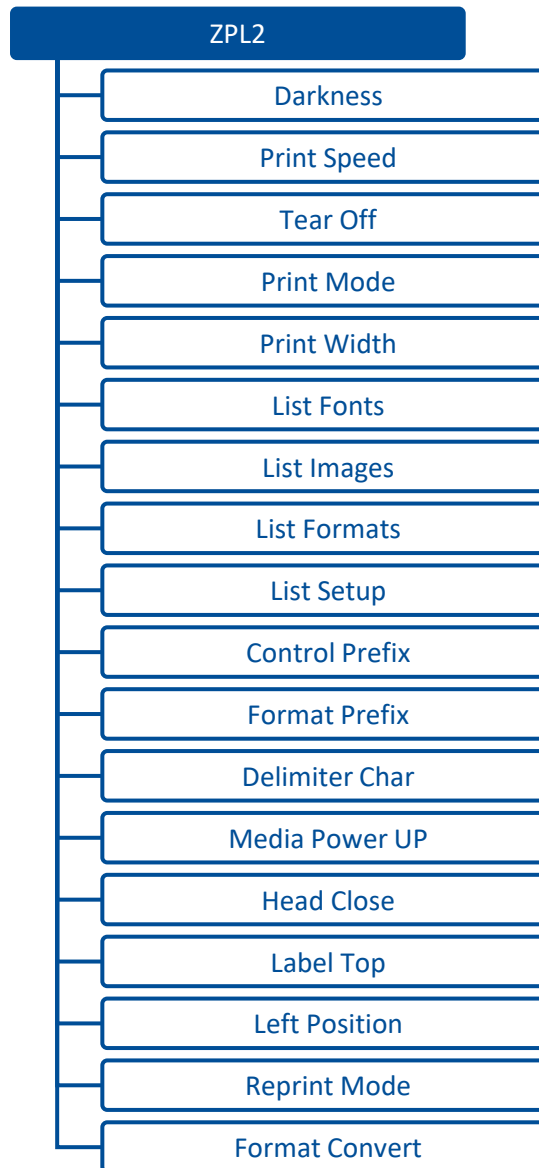

Item	Description	Default
Density	Set the printing darkness. Available setting range: 0 to 30.	16
Print Speed	Set the print speed. Available setting range is 1 to 10 for 203dpi and 1 to 7 for 300dpi.	203 dpi: 5 300 dpi: 3
Tear Off	Adjust media stop location. Available setting value range: -120 to 120 dots.	0 dot
Print mode	Set the print mode. There are 4 modes: <ul style="list-style-type: none"> • Tear Off: Next label top of form is aligned to the printhead heating line location. • Peeler Off: Enable the label peel off mode. • Cutter: Enable the label cutter mode • Rewind: Enable the label rewind mode 	Tear Off
Print Width	Set the print width. Available setting range: 2 to 999 dots.	812 dot
List Fonts	Print the current fonts list from the memory devices to the label.	N/A
List Images	Print current printer available images list stored at the memory device to the label.	N/A
List Formats	Print current printer available formats list from the memory devices to the label.	N/A
List Setup	Print current printer configuration to the label.	N/A
Control Prefix	Set control prefix character.	N/A
Format Prefix	Set format prefix character.	N/A
Delimiter Char	Set delimiter character.	N/A
Media Power Up	Set the action of the media when turning on the printer. <ul style="list-style-type: none"> • Feed: Printer will advance one label. • Calibration: Printer will make calibration. • Length: Printer determine length and feed label. • No Motion: Printer will not move media. 	No Motion
Head Close	Set the action of the media when closing the printhead. <ul style="list-style-type: none"> • Feed: Printer will advance one label. • Calibration: Printer will make calibration. • Length: Printer determine length and feed label. • No Motion: Printer will not move media. 	No Motion
Label Top	Adjust print position vertically on the label. Value range: -120 to +120 dots.	0 dot

Item	Description	Default
Left Position	Adjust print position horizontally on the label. Value range:-9999 to +9999 dots.	0
Reprint Mode	Reprint the last label by pressing up arrow key () on printer's control panel.	Disable
Format Convert	<p>Select the bitmap scaling factor. The first number is the original dots per inch (dpi) value; the second the dpi which you would like to scale.</p> <ul style="list-style-type: none"> • None: No change • 300 -> 600 • 200 -> 600 • 150 -> 600 • 150 -> 300 	None

6.4 Sensor

The setting options in the Sensor menu allows users to calibrate the printer based on what kind of the media they want to use. It is recommended to run the sensor calibration anytime you use a different media.

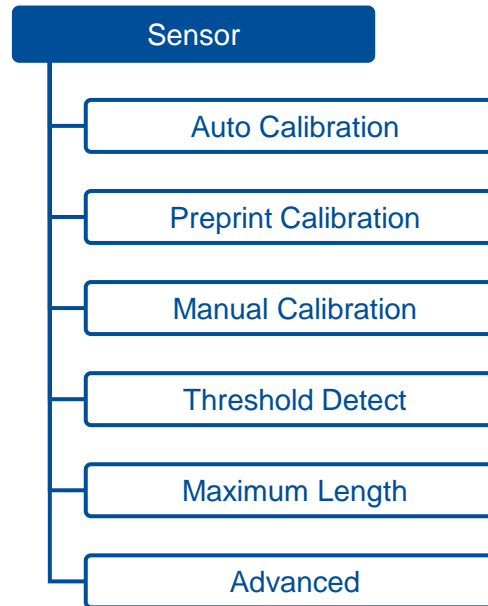

Item	Description	Default
Auto Calibration	Set the media sensor type and calibrate the selected sensor automatically. <ul style="list-style-type: none"> • Gap • Black Mark • Continuous 	N/A
Preprint Calibration	Runs the calibration automatically when using the preprinted labels. <ul style="list-style-type: none"> • Gap • Black Mark 	N/A
Manual Calibration	In case Auto Calibration does not work, please use “Manual” function to set the paper length and gap/black mark size to complete the calibration setting. <ul style="list-style-type: none"> • Gap 	N/A

	<ul style="list-style-type: none"> • Black Mark • Continuous 	
Threshold Detect	Sets the sensor's sensitivity. Setting options: Auto / Fixed.	Auto
Maximum Length	Specifies the maximum length for label calibration. Setting range: 1 to 9999 mm.	253 mm
Advanced	<p>Specifies the minimum label length and the maximum gap or black mark length before running Auto Calibration.</p> <ul style="list-style-type: none"> • Min. Paper (setting range: 0 to 999 mm.) • Max. Gap/Mark (setting range: 0 to 999 mm.) 	0 mm

6.5 Interface

Interface menu allows users to configure the printer's I/O interfaces.

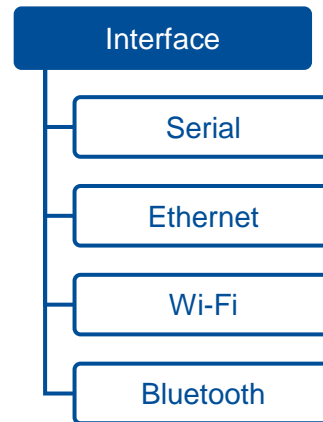

6.5.1 Serial COM

The table below describes the configurable items for the printer's RS-232 interface.

Item	Description	Default
Baud Rate	Sets Baud Rate for the RS-232 interface. Setting options: 1200 / 2400 / 4800 / 9600 / 19200 / 38400 / 57600 / 115200 bps.	9600
Parity	Sets parity check for the RS-232 interface. Setting options: None / Even / Odd.	None
Data Bits	Sets the number of bits in a data frame for the RS-232 interface. Setting options: 7 / 8.	8
Stop Bit(s)	Sets the number of stop bits that mark the end of a frame for the RS-232 interface. Setting options: 1 / 2.	1

6.5.2 Ethernet

The table below describes the configurable items for the printer's Ethernet interface.

Item	Description	Default
Network Interface	Sets the network interface. Setting options: Ethernet / Wi-Fi. Note: If you have used Wi-Fi interface before, you have to switch to Ethernet here first.	N/A
Status	Displays information about the Ethernet connection if the printer is connected to a wired network.	N/A
Configure	Select to use a DHCP server or non-DHCP server. <ul style="list-style-type: none">• DHCP: Select to use a DHCP (Dynamic Host Configuration Protocol) network protocol.• Static IP: Select to use a non-DHCP server. You need to manually enter the IP address, subnet mask, and default gateway.	N/A

6.5.3 Wi-Fi

The table below describes the configurable items for the printer's Wi-Fi connection.

Item	Description	Default
Network Interface	Sets the network interface. Setting options: Ethernet / Wi-Fi. Note: If you are connected to Wi-Fi network before, you have to switch to Wi-Fi here first.	N/A
Status	Displays information about the Wi-Fi connection if the printer is connected to a wireless network.	N/A
Config.	Select to use a DHCP server or non-DHCP server. <ul style="list-style-type: none">• DHCP: Select to use a DHCP (Dynamic Host Configuration Protocol) network protocol.• Static IP: Select to use a non-DHCP server. You need to manually enter the IP address, subnet mask, and default gateway.	DHCP
SSID	Sets SSID for the Wi-Fi connection.	N/A

Security	Sets security type for the Wi-Fi connection.	Open
Password	Sets a password for the Wi-Fi connection.	N/A

6.5.4 Bluetooth



The table below describes the configurable items for the Bluetooth interface.

Item	Description	Default
Status	Displays information about the Bluetooth status.	N/A
Local Name	Sets the local name for Bluetooth.	PS-XXXXXX Note: XXXXXX indicates the last six digits of the MAC address. You can find the MAC address in the Status item.
Pair Mode	Sets the pair mode for Bluetooth. <ul style="list-style-type: none"> • LEGACY • JUSTWORK Note: This setting item is for MFi module only.	LEGACY
PIN Code	Sets the local ping code for Bluetooth.	0000

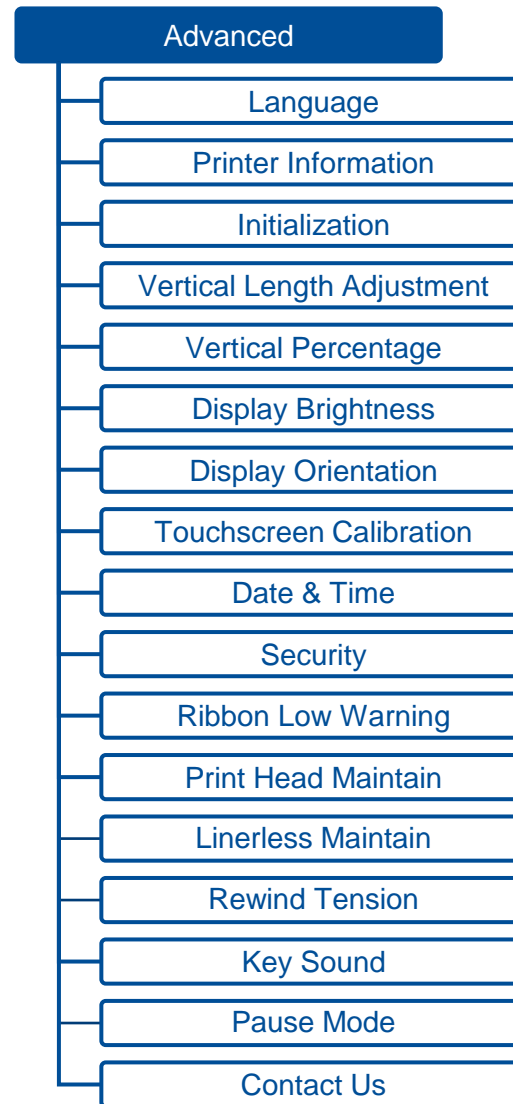
6.6 Advanced



Item	Description	Default
Language	Switch the language on display.	English
Printer Information	Check the printer's serial number, printed mileage (m), printed labels (pcs) and cutting counter.	N/A
Initialization	Reset printer settings to factory defaults.	N/A
Vertical Length Adjustment	Turn on/off the Vertical Length Adjustment function.	OFF
Vertical Percentage	Adjust the label length. Setting range: 90 to 115%. Note: This subsection will only be visible when the "Vertical Length Adjustment" item is turned on.	100
Display Brightness	Set the brightness for display. Setting range: 0 to 100.	50
Display Orientation	Set the orientation for the display. Setting options: 0 / 180.	0
Touchscreen Calibration	Calibrate the touchscreen for best result.	N/A
Date & Time	Setup the date and time on display. <ul style="list-style-type: none"> • Date Format: Set the date display format. (YYYY/MM/DD, DD/MM/YYYY, MM/DD/YYYY, YYYY-MM-DD, DD-MM-YYYY, MM-DD-YYYY) • Date: Adjust the date. • Time Format: Set the time display format. (12 hr/ 24 hr) • Time: Set the time. 	N/A
Security	Set the password for locking the menu and the favorites. Default password: 8888.	Disable
Ribbon Low Warning	Set the warning for ribbon low. For example, if setting value is 30m, when ribbon capacity was lower than 30m, the number of meters remaining next to the icon ( 30m) will be shown in red. Setting range: 10 to 100 m.	30m

Item	Description	Default
<p>Print Head Maintain</p>	<p>Check printhead status and to set the settings for printhead care.</p> <ul style="list-style-type: none"> • Warning: Turn on/off the printhead maintenance warning. If enable this feature, once printhead has been reached the setting mileage then the warning icon () will be shown on printer UI for reminding user to clean the printhead. Default setting: OFF. • Reset Counter: Reset the printhead clean warning mileage after cleaning printhead. • Interval: Set mileage count for the printhead. When the set amount of mileage is fulfilled, the warning icon that reminds users to clean the printhead will appear on the display panel. Default setting: 1 km. 	<p>N/A</p>
<p>Linerless Maintain</p>	<p>Set how often the linerless cutter blade should be cleaned.</p> <ul style="list-style-type: none"> • Warning: Turns on/off notification that reminds users to clean the cutter blade if the set mileage for the cutter blade is fulfilled. Default setting: ON. • Interval: Sets mileage for the cutter blade. When the set amount of mileage is fulfilled, the warning icon () that reminds users to clean the cutter blade will appear on the display panel. Default setting: 1 km. • Clean Cutter Blade: Lifts up to expose the cutter blade. Select this item to lift up the cutter blade if you need to clean the blade. (Linerless cutter printer only) <p>NOTE: For how to clean the linerless cutter blade, please refer to Maintenance for more information.</p> <p>CAUTION: To avoid the risk of personal injury, keep your hands away from the cutter gate when selecting Clean Cutter Blade. Selecting this item will lift up the blade.</p> <ul style="list-style-type: none"> • Reset Counter: Resets the mileage count after cleaning the cutter blade. <p>Note:</p> <ul style="list-style-type: none"> ▪ These options can also be quickly accessed directly from "Favorites" (touch LCD only) to set them up. ▪ This subsection will only be visible when the linerless module installed. 	<p>N/A</p>
<p>Rewind Tension</p>	<p>Set the ribbon rewind tension %. Setting range: -50 to 50%.</p>	<p>0%</p>
<p>Key Sound</p>	<p>Turns on/off the sounds when tapping the touchscreen or pressing the function buttons.</p>	<p>ON</p>

Item	Description	Default
Pause Mode	This item is used to enable/disable the printer into pause mode (Off line). After selecting “enable”, press the down arrow key () and the printer will pause all actions.	Disable
Contact us	Check the contact information for tech support service	N/A

6.7 File Manager

File Manager allows users to check the remaining space of the printer's built-in memory and manage or execute the files saved in the printer's DRAM/Flash memory or micro SD card.

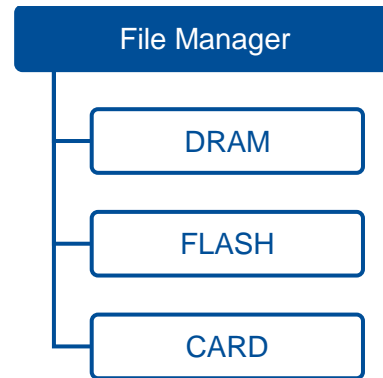

Item	Description
DRAM	Allows users to manage or execute files (.BAS) saved in the printer's DRAM.
FLASH	Allows users to manage or execute files (.BAS) saved in the printer's Flash memory.
CARD	Allows users to manage or execute files (.BAS) saved in the micro SD card. Note: This subsection will only be visible when the SD card installed.

6.8 Diagnostic

The illustration and table below describe the functions in the **Diagnostic** menu.

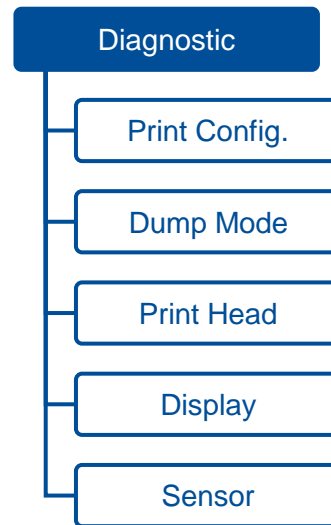

Item	Description
Print Config.	Print current printer configuration to the label. The configuration printout contains printhead test pattern, which is useful for checking the dot damage on the printhead heater.
Dump Mode	Captures the data from the communications port and prints out the data received by printer. In the dump mode, all characters will be printed in 2 columns. The left side characters are received from your system and right side data are the corresponding hexadecimal value of the characters. It allows users or engineers to verify and debug the program. Note: Dump mode requires 4" wide paper width.
Printhead	Check printhead's temperature and bad dots.
Display	Check LCD's color state.
Sensor	Check sensors intensity and reading state.

6.9 Favorites (Touch LCD Only)

Favorites helps users build a commonly used list. Arrange the commonly used setting options by **Favorites** .

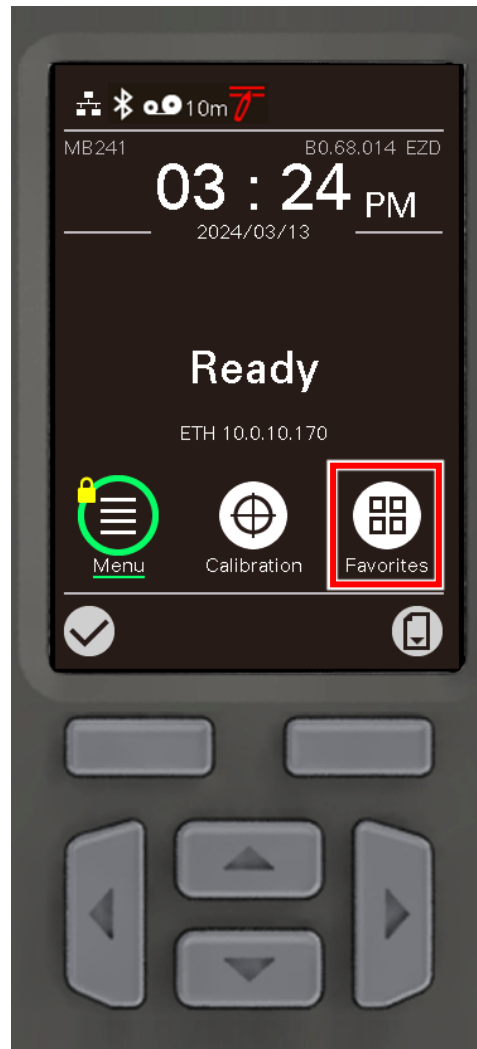

- **Add items:** Touch and hold the item > window of **Join Favorites** will pop up > tap **Yes** to add the item to **Favorites**.

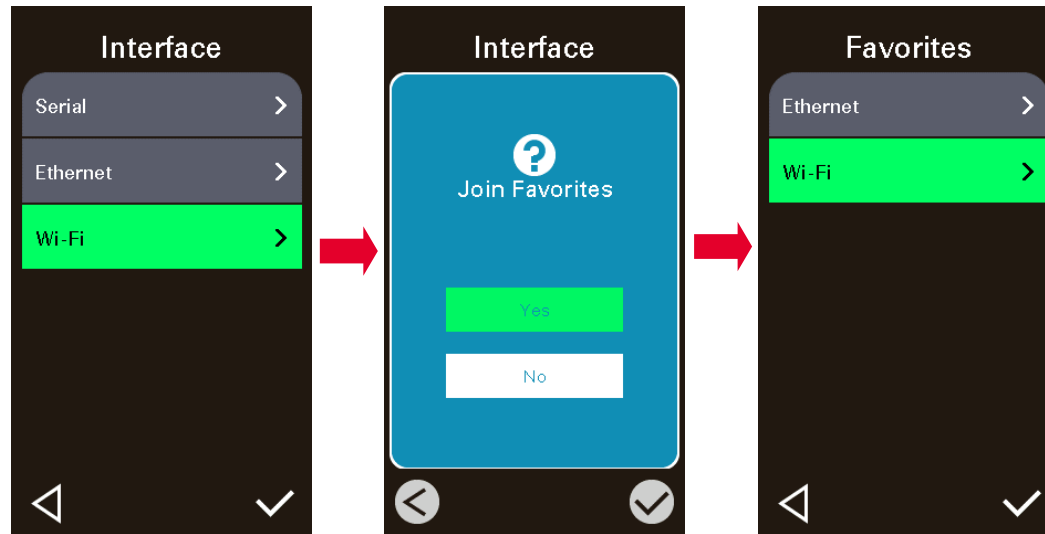

- **Delete items:** Touch and hold the item > window of **Delete Favorites** will pop up > tap **Yes** to delete the item.

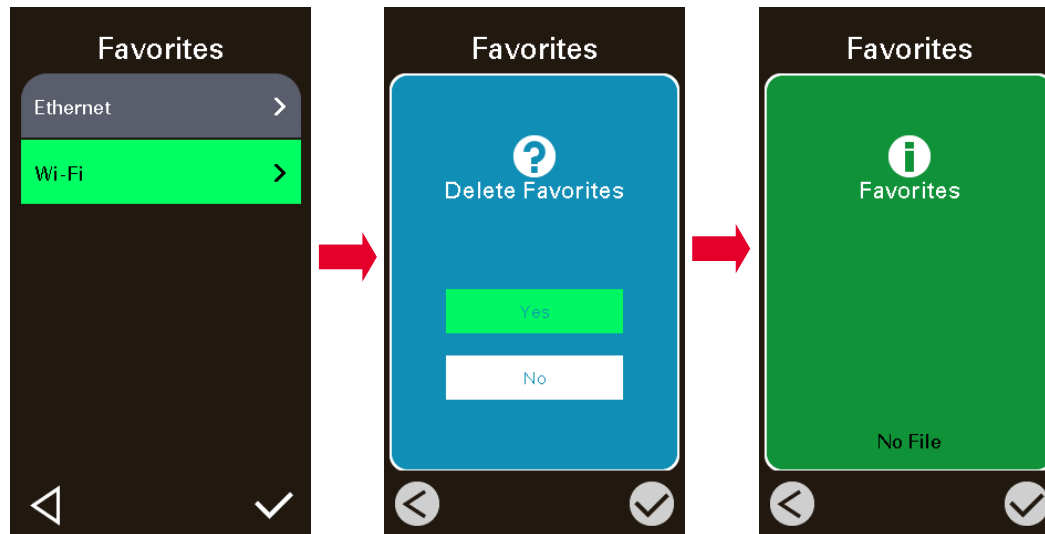

6.10 Configuring the Printer and Setting Options for the Linerless Media

1. After loading the linerless media into the printer, perform the calibration  to calibrate the media sensor (Continuous).
2. When the calibration is finished, enter the printer LCD Menu to configure the linerless printer. Select **Setting**. Make sure the Command Set is set to **TSPL**.
For linerless tear module, select **Print Mode** and set the print mode to **Peeler Mode**.
For linerless cutter module, select **Print Mode** and set the print mode to **Cutter Mode**.

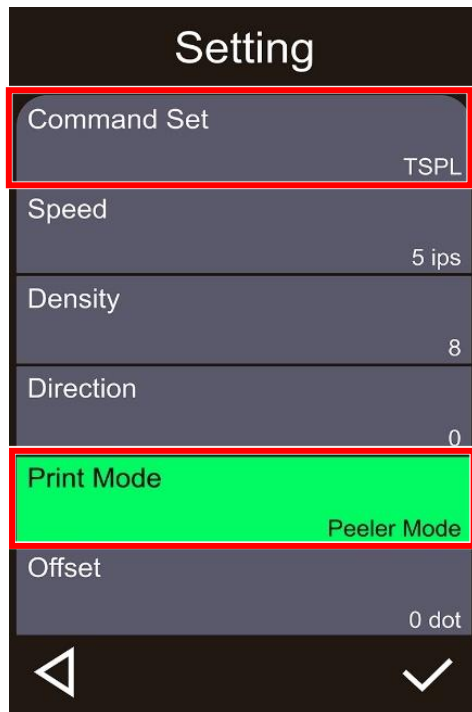

Note:
The **Print Mode** can also be set through the **Driver** or the **TSC Console**.

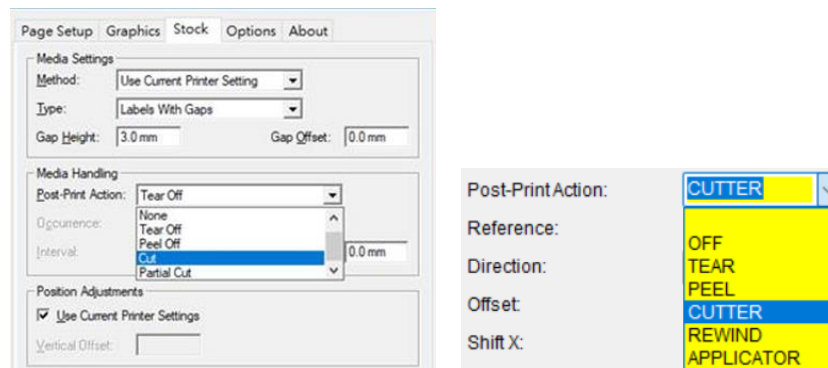

The following paragraph describes the setting options that help optimize the print quality when using the linerless media. The setting options will automatically appear in the **Favorites** folder (touch LCD only) after installing the linerless cutter/tear-off module onto the printer. (for 2.3" LCD models, refer to [Advanced](#) section)

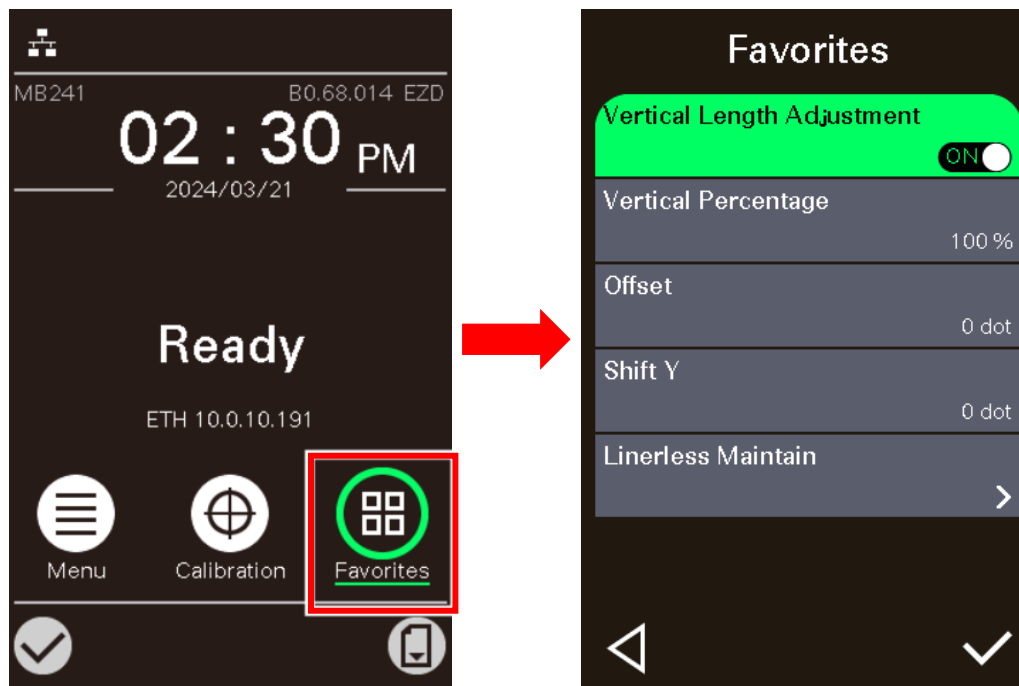

Item	Description
Vertical Length Adjustment	Turns on/off the Vertical Length Adjustment function. Setting option: ON / OFF .
Vertical Percentage	Adjusts the label length. This item will not appear if Vertical Length Adjustment is turned off. Setting range: 90 to 115%.
Offset	Specifies the stop position for each operation. Setting range: -203 to 203 dots.
Shift Y	Specifies the amount to shift an image vertically up or down for precise print position on the label. Setting range: -203 to 203 dots.

Item	Description
<p style="text-align: center;">Linerless Maintain</p>	<p>Sets how often the printer should be cleaned after printing with the linerless media.</p> <p>Warning: Turns on/off notification that reminds users to clean the printer if the set mileage is fulfilled. Default setting: ON.</p> <p>Interval: Schedules printer maintenance after printing with the linerless media. When the set amount of mileage is fulfilled, the warning icon () that reminds users to clean the printer will appear on the display panel. Default setting: 1 km.</p> <p>Clean Cutter Blade: Lifts up to expose the cutter blade. Select this item to lift up the cutter blade if you need to clean the blade.</p> <p>NOTE: Clean Cutter Blade will be displayed in the menu after installing the cutter module on the printer. For how to clean the linerless cutter blade, please refer to Maintenance for more information.</p> <p>CAUTION: To avoid the risk of personal injury, keep your hands away from the cutter gate when selecting Clean Cutter Blade. Selecting this item will lift up the blade.</p> <p>Reset Counter: Resets the mileage count after cleaning the printer.</p>

7. Troubleshooting

The table below shows common problems and solutions for the average operator; if you have followed our suggested troubleshooting and the printer is still not functioning properly, please contact your purchasing dealer's technical support department for further assistance.

Problem	Possible Cause	Recovery Procedure
Power indicator does not illuminate	<ul style="list-style-type: none"> ■ The power cord is not properly connected. ■ The power switch is closed. 	<ul style="list-style-type: none"> ■ Plug the power cord in printer and outlet. ■ Switch the printer on.
Carriage Open	<ul style="list-style-type: none"> ■ The printer carriage is open. 	<ul style="list-style-type: none"> ■ Close the print carriage.
Not Printing	<ul style="list-style-type: none"> ■ Check if interface cable is well connected. ■ Check if wireless or Bluetooth device is well connected. ■ The port in the Windows driver is not correct. 	<ul style="list-style-type: none"> ■ Re-connect cable to interface or change a new cable. ■ Reset the wireless device setting. ■ Select the correct printer port in the driver. ■ Printhead's harness connector is not well connected with printhead. Turn off the printer and plug the connector again. ■ Check your program if there is a command - PRINT at the end of the file and there must have CRLF at the end of each command line.
No print on the label	<ul style="list-style-type: none"> ■ Label or ribbon is loaded not correctly. ■ Use wrong type paper or ribbon 	<ul style="list-style-type: none"> ■ Follow the instructions in loading the media and ribbon. ■ Ribbon and media are not compatible. ■ Verify the ribbon-inked side. ■ Clean the printhead. ■ The print density setting is incorrect.
No Ribbon	<ul style="list-style-type: none"> ■ Running out of ribbon. ■ The ribbon is installed incorrectly. 	<ul style="list-style-type: none"> ■ Supply a new ribbon roll. ■ Refer to user's manual to reinstall the ribbon.
No Paper	<ul style="list-style-type: none"> ■ Running out of label. ■ The label is installed incorrectly. 	<ul style="list-style-type: none"> ■ Supply a new label roll. ■ Refer to user's manual to reinstall the label roll.

Problem	Possible Cause	Recovery Procedure
	<ul style="list-style-type: none"> ■ Gap/black mark sensor is not calibrated. 	<ul style="list-style-type: none"> ■ Calibrate the gap/black mark sensor.
Paper Jam	<ul style="list-style-type: none"> ■ Gap/black mark sensor is not set properly. ■ Make sure label size is set properly. ■ Labels may be stuck inside the printer mechanism. 	<ul style="list-style-type: none"> ■ Calibrate the media sensor. ■ Set media size correctly. ■ Remove the stuck label inside the printer mechanism.
Take Label	<ul style="list-style-type: none"> ■ Peel function is enabled. 	<ul style="list-style-type: none"> ■ If peeler module is installed, please remove the label. ■ If there is no peeler module in front of the printer, please switch off the printer and install it. ■ Check if the connector is plugging correctly.
Can't downloading the file to memory (FLASH / DRAM/CARD)	<ul style="list-style-type: none"> ■ The space of memory is full. 	<ul style="list-style-type: none"> ■ Delete unused files in the memory.
Poor Print Quality	<ul style="list-style-type: none"> ■ Ribbon and media are loaded incorrectly. ■ Dust or adhesive accumulation on the printhead. ■ Printing density is not set properly. ■ Printing speed is not set properly. ■ Printhead element is damaged. ■ Ribbon and media are incompatible. ■ The printhead pressure is not set properly. 	<ul style="list-style-type: none"> ■ Reload the supply. ■ Clean the printhead. ■ Clean the platen roller. ■ Adjust the print density and print speed. ■ Run printer self-test and check the printhead test pattern if there is dot missing in the pattern. ■ Change proper ribbon or proper label media. ■ Adjust the printhead pressure adjustment knob. ■ The release lever does not latch the printhead properly.
Missing printing on the left or right side of label	<ul style="list-style-type: none"> ■ Wrong label size setup. 	<ul style="list-style-type: none"> ■ Set the correct label size.
Gray line on the blank label	<ul style="list-style-type: none"> ■ The printhead is dirty. ■ The platen roller is dirty. 	<ul style="list-style-type: none"> ■ Clean the printhead. ■ Clean the platen roller.
Irregular printing	<ul style="list-style-type: none"> ■ The printer is in Hex Dump mode. ■ The RS-232 setting is incorrect. 	<ul style="list-style-type: none"> ■ Turn off and on the printer to skip the dump mode. ■ Re-set the RS-232 setting.

Problem	Possible Cause	Recovery Procedure
Label feeding is not stable (skew) when printing	<ul style="list-style-type: none"> The media guide does not touch the edge of the media. 	<ul style="list-style-type: none"> If the label is moving to the right side, please move the label guide to left. If the label is moving to the left side, please move the label guide to right.
Skip labels when printing	<ul style="list-style-type: none"> Label size is not specified properly. Sensor sensitivity is not set properly. The media sensor is covered with dust. 	<ul style="list-style-type: none"> Check if label size is setup correctly. Calibrate the sensor by Auto Gap or Manual Gap options. Clear the GAP/Black mark sensor by blower.
Wrinkle Problem	<ul style="list-style-type: none"> Printhead pressure is incorrect. Ribbon installation is incorrect. Media installation is incorrect. Print density is incorrect. Media feeding is incorrect. 	<ul style="list-style-type: none"> Please refer to the Mechanism Fine Adjustment to Avoid Ribbon Wrinkles. Please set the suitable density to have good print quality. Make sure the label guide touch the edge of the media guide.
RTC time is incorrect when reboot the printer	<ul style="list-style-type: none"> The battery has run down. 	<ul style="list-style-type: none"> Check if there is a battery on the main board.
The left side printout position is incorrect	<ul style="list-style-type: none"> Wrong label size setup. The parameter Shift X in LCD menu is incorrect. 	<ul style="list-style-type: none"> Set the correct label size. Press [Menu] → [Setting] → [Shift X] to fine tune the parameter of Shift X.
The printing position of small label is incorrect	<ul style="list-style-type: none"> Media sensor sensitivity is not set properly. Label size is incorrect. The parameter Shift Y in the LCD menu is incorrect. The vertical offset setting in the driver is incorrect. 	<ul style="list-style-type: none"> Calibrate the sensor sensitivity again. Set the correct label size and gap size. Press [Menu] → [Setting] → [Shift Y] → to fine tune the parameter of Shift Y. Set the vertical offset in the driver if you're using BarTender.
LCD panel is dark and keys are not working	<ul style="list-style-type: none"> The cable between main PCB and LCD panel is loose. 	<ul style="list-style-type: none"> Check if the cable between main PCB and LCD is secured or not.
LCD panel is dark but the LEDs are light	<ul style="list-style-type: none"> The printer initialization is unsuccessful. 	<ul style="list-style-type: none"> Turn OFF and ON the printer again.

Problem	Possible Cause	Recovery Procedure
		<ul style="list-style-type: none"> ■ Initialize the printer.
Ribbon encoder sensor doesn't work	<ul style="list-style-type: none"> ■ The ribbon encoder sensor connector is loose. 	<ul style="list-style-type: none"> ■ Fasten the connector.
Ribbon end sensor doesn't work	<ul style="list-style-type: none"> ■ The connector is loose. ■ The ribbon sensor hole is covered with dust. 	<ul style="list-style-type: none"> ■ Check the connector. ■ Clear the dust in the sensor hole by the blower.
Cutter is not working	<ul style="list-style-type: none"> ■ The connector is loose. ■ The print mode setting is incorrect. 	<ul style="list-style-type: none"> ■ Plug in the connect cable correctly. ■ Set the print mode to Cutter Mode

8. Maintenance

This session presents the clean tools and methods to maintain the printer.

■ For Cleaning

Depending on the media used, the printer may accumulate residues (media dust, adhesives, etc.) as a by-product of normal printing. To maintain the best printing quality, you should remove these residues by cleaning the printer periodically. Regularly clean the printhead and supply sensors once change a new media to keep the printer at the optimized performance and extend printer life.

■ For Disinfecting

Sanitize your printer to protect yourself and others and can help prevent the spread of viruses.

■ Important

- Set the printer power switch to O (Off) prior to performing any cleaning or disinfecting tasks. Leave the power cord connected to keep the printer grounded and to reduce the risk of electrostatic damage.
- Do not wear rings or other metallic objects while cleaning any interior area of the printer.
- Use only the cleaning agents recommended in this document. Use of other agents may damage the printer and void its warranty.
- Do not spray or drip liquid cleaning solutions directly into the printer. Apply the solution on a clean lint-free cloth and then apply the dampened cloth to the printer.
- Do not use canned air in the interior of the printer as it can blow dust and debris onto sensors and other critical components.
- Only use a vacuum cleaner with a nozzle and hose that are conductive and grounded to drain off static build up.
- All reference in these procedures for use of isopropyl alcohol requires that a 99% or greater isopropyl alcohol content be used to reduce the risk of moisture corrosion to the printhead.
- Do not touch printhead by hand. If you touch it careless, please use 99% Isopropyl alcohol to clean it.
- Always taking personal precaution when using any cleaning agent.

Cleaning Tools



- Cotton swab
- Lint-free cloth
- Brush with soft non-metallic bristles
- Vacuum cleaner
- 75% Ethanol (for disinfecting)
- 99% Isopropyl alcohol (for printhead and platen roller cleaning)
- Genuine printhead cleaning pen
- Mild detergent (without chlorine)







Cleaning Process:

Printer Part	Method	Interval
Printhead	<ol style="list-style-type: none"> I. Always turn off the printer before cleaning the printhead. II. Allow the printhead to cool for at least one minute. III. Use a cotton swab and 99% Isopropyl Alcohol or genuine printhead cleaning pen to clean the printhead surface. 	Clean the printhead when changing a new label roll.
Standard Platen Roller	<ol style="list-style-type: none"> I. Turn off the printer. II. Rotate the platen roller and wipe it thoroughly with the lint-free 99% Isopropyl Alcohol. 	Clean the platen roller when changing a new label roll
Peel Bar	Use the lint-free cloth with 99% Isopropyl Alcohol to wipe it.	As needed
Sensor	Use brush with soft non-metallic bristles or a vacuum cleaner, to remove paper dust. Clean upper and lower media sensors to ensure reliable Top of Form and Paper Out sensing.	Monthly
Exterior	Clean the exterior surfaces with a clean, lint-free cloth (water-dampened cloth). If necessary, use a mild detergent or desktop cleaning solution then use the 75% Ethanol to wipe it.	As needed
Interior	Clean the interior of the printer by removing any dirt and lint with a vacuum cleaner, as described above, or use a brush with soft non-metallic bristles then use the 75% Ethanol to wipe it.	As needed

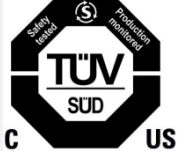
Linerless Printer	Please refer to Linerless Cleaning Kit User Manual for more information. 	<ul style="list-style-type: none">◆ Clean as needed or after printing every 1km.◆ Please determine the maintenance intervals based on actual usage.
--------------------------	---	--

9. Agency Compliance and Approvals

	<p>EN 55032, Class A EN 55035, EN 301489-1,-17 EN 300 328 EN 62311 EN 60950-1</p> <p>This is a class A product. In a domestic environment this product may cause radio interference in which case the user may be required to take adequate measures.</p>
	<p>FCC part 15B, Class A ICES-003, Class A</p> <p>This equipment has been tested and found to comply with the limits for a Class A digital device, pursuant to Part 15 of the FCC Rules. These limits are designed to provide reasonable protection against harmful interference when the equipment is operated in a commercial environment.</p> <p>This equipment generates, uses, and can radiate radio frequency energy and, if not installed and used in accordance with the manufacturer’s instruction manual, may cause harmful interference with radio communications. Operation of this equipment in a residential area is likely to cause harmful interference, in which case you will be required to correct the interference at your own expense.</p> <p>This Class A digital apparatus complies with Canadian ICES-003. Cet appareil numérique de la classe A est conforme à la norme NMB-003 du Canada.</p> <p>This device complies with Part 15 of the FCC Rules. Operation is subject to the following two conditions: (1) This device may cause harmful interference, and (2) this device must accept any interference received, including interference that may cause undesired operation.</p>
	<p>AS/NZS CISPR 32, Class A AS/NZS 4268 AS/NZS 2772.2</p>

	<p>UL 62368-1 CSA C22.2 No. 62368-1</p>
	<p>EN 62368-1</p>
	<p>KS C 9832 / KS C 983535 이 기기는 업무용(A 급) 전자파적합기기로서 판매자 또는 사용자는 이 점을 주의하시기 바라며, 가정외의 지역에서 사용하는 것을 목적으로 합니다.</p>
	<p>GB 4943.1 GB 9254, Class A GB 17625.1 此为 A 级产品，在生活环境中，该产品可能会造成无线电干扰，在这种情况下，可能需要用户对干扰采取切实可行的措施。</p>
	<p>Energy Star for Imaging Equipment Version 3.2</p>
	<p>IS 13252(Part 1)/ IEC 60950-1</p>
	<p>CNS 15936 甲類 CNS 15598-1 CNS 15663</p>
	<p>LP0002</p>

Note: There may have certification differences in the series models, please refer to product label for accuracy.

Important safety instructions:

1. Read all of these instructions and keep them for later use.
2. Follow all warnings and instructions on the product.
3. Disconnect the power plug from the AC outlet before cleaning or if fault happened.
Do not use liquid or aerosol cleaners. Using a damp cloth is suitable for cleaning.
4. The mains socket shall be installed near the equipment and easily accessible.
5. The unit must be protected against moisture.
6. Ensure the stability when installing the device, Tipping or dropping could cause damage.
7. Make sure to follow the correct power rating and power type indicated on marking label provided by manufacture.
8. Please refer to user manual for maximum operation ambient temperature.

WARNING:

Hazardous moving parts, keep fingers and other body parts away.

CAUTION:

(For equipment with RTC (CR2032) battery or rechargeable battery pack)

Risk of explosion if battery is replaced by an incorrect type.

Dispose of used batteries according to the Instructions as below.

1. DO NOT throw the battery in fire.
2. DO NOT short circuit the contacts.
3. DO NOT disassemble the battery.
4. DO NOT throw the battery in municipal waste.
5. The symbol of the crossed out wheeled bin indicates that the battery should not be placed in municipal waste.



Caution: The printhead may be hot and could cause severe burns. Allow the printhead to cool.

WARNING:

For operation safety, please turn off the power by the power switch before opening the media cover to load labels, ribbons, or to repair. After

completing the steps, please close the media cover first and then turn on the power to start printing.

CAUTION:

Any changes or modifications not expressly approved by the grantee of this device could void the user's authority to operate the equipment.

Below statement are for product with optional RF function.

CE Statement:

This equipment complies with EU radiation exposure limits set forth for an uncontrolled environment. This equipment should be installed and operated with minimum distance 20 cm between the radiator & your body.

All operational modes:

2.4GHz: 802.11b, 802.11g, 802.11n (HT20), 802.11n (HT40)

5GHz: 802.11a,

The frequency, mode and the maximum transmitted power in EU are listed below:

2410 MHz – 2483.5 MHz: 19.88 dBm (EIRP)(Wi-Fi)

5150 MHz – 5250 MHz: 17.51 dBm (EIRP)(Wi-Fi)

2412 MHz – 2480 MHz: 6.02 dBm (EIRP)(Bluetooth)

Requirements in AT/BE/BG/CZ/DK/EE/FR/DE/IS/IE/IT/EL/ES/CY/LV/LI/LT/LU/HU/MT/NL/NO/PL/PT/RO/SI/SK/TR/FI/SE/CH/UK/HR. 5150MHz-5350MHz is for indoor use only.

5150-5350MHz for Only indoor use

5470-5725MHz for indoor/outdoor use



Restrictions In AZE

National restrictions information is provided below

Frequency Band	Country	Remark
5150-5350MHz	Azerbaijan	No license needed if used indoor and

5470-5725MHz		power not exceeding 30mW
--------------	--	--------------------------

Hereby, TSC Auto ID Technology Co., Ltd. declares that the radio equipment type [Wi-Fi] IEEE 802.11 a/b/g/n is in compliance with Directive 2014/53/EU

The full text of the EU declaration of conformity is available at the following internet address: <http://www.tscprinters.com/cms/theme/index-39.html>

RF exposure warning (Wi-Fi)

This equipment must be installed and operated in accordance with provided instructions and must not be co-located or operating in conjunction with any other antenna or transmitter. End-users and installers must be providing with antenna installation instructions and transmitter operating conditions for satisfying RF exposure compliance.

SAR Value: 0.736 W/kg

RF exposure warning (For Bluetooth)

The equipment complies with FCC RF exposure limits set forth for an uncontrolled environment.

The equipment must not be co-located or operating in conjunction with any other antenna or transmitter.

Canada, Industry Canada (IC) Notices

This Class B digital apparatus complies with Canadian ICES-003 and RSS-210.

Operation is subject to the following two conditions: (1) this device may not cause interference, and (2) this device must accept any interference, including interference that may cause undesired operation of the device.

Radio Frequency (RF) Exposure Information

The radiated output power of the Wireless Device is below the Industry Canada (IC) radio frequency exposure limits. The Wireless Device should be used in such a manner such that the potential for human contact during normal operation is minimized.

This device has been evaluated for and shown compliant with the IC Specific Absorption Rate ("SAR") limits when installed in specific host products operated in portable exposure conditions. **(For Wi-Fi)**

This device has also been evaluated and shown compliant with the IC RF Exposure limits under portable exposure conditions. (Antennas are less than 20 cm of a person's body). **(For Bluetooth)**

Canada, avis de l'Industry Canada (IC)

Cet appareil numérique de classe B est conforme aux normes canadiennes ICES-003 et RSS-210.

Son fonctionnement est soumis aux deux conditions suivantes : (1) cet appareil ne doit pas causer d'interférence et (2) cet appareil doit accepter toute interférence, notamment les interférences qui peuvent affecter son fonctionnement.

Informations concernant l'exposition aux fréquences radio (RF)

La puissance de sortie émise par l'appareil sans fil est inférieure à la limite d'exposition aux fréquences radio de l'Industry Canada (IC). Utilisez l'appareil sans fil de façon à minimiser les contacts humains lors du fonctionnement normal.

Ce périphérique a été évalué et démontré conforme aux limites SAR (Specific Absorption Rate – Taux d'absorption spécifique) par l'IC lorsqu'il est connecté à des dispositifs hôtes spécifiques opérant dans des conditions d'utilisation mobile. **(Pour le Wi-Fi)**

Ce périphérique a également été évalué et démontré conforme aux limites d'exposition radio-fréquence par l'IC pour des utilisations par des opérateurs mobiles (les antennes sont à moins de 20 cm du corps d'une personne). **(Pour le Bluetooth)**

NCC 警語:

經型式認證合格之低功率射頻電機，非經許可，公司、商號或使用者均不得擅自變更頻率、加大功率或變更原設計之特性及功能。(即低

功率電波輻射性電機管理辦法第十二條)

低功率射頻電機之使用不得影響飛航安全及干擾合法通信；經發現有干擾現象時，應立即停用，並改善至無干擾時方得繼續使用。

前項合法通信，指依電信法規定作業之無線電通信。低功率射頻電機須忍受合法通信或工業、科學及醫療用電波輻射性電機設備之干擾。(即低功率電波輻射性電機管理辦法第十四條)

BSMI Class A 警語:

這是甲類的資訊產品，在居住的環境使用中時，可能會造成射頻 干擾，在這種情況下，使用者會被要求採取某些適當的對策。

MFi for Bluetooth



Use of the Made for Apple badge means that an accessory has been designed to connect specifically to the Apple product(s) identified in the badge, and has been certified by the developer to meet Apple performance standards. Apple is not responsible for the operation of this device or its compliance with safety and regulatory standards.

For US Model

Made for iPhone®XS Max, iPhone XS, iPhone XR, iPhone X, iPhone 8, iPhone 8 Plus, iPhone 7, iPhone 7 Plus, iPhone SE, iPhone 6s, iPhone 6s Plus, iPhone 6, iPhone 6 Plus, iPhone 5s, iPad Pro® 12.9-inch (2nd generation), iPad Pro 10.5-inch, iPad® (6th generation), iPad (5th generation), iPad Pro 9.7-inch, iPad Pro 12.9-inch (1st generation), iPad Air® 2, iPad mini™ 4, iPad mini 3, iPad Air, iPad mini 2, iPod touch® (6th generation)

iPad, iPad Air, iPad Pro, iPhone are trademarks of Apple Inc., registered in the U.S. and other countries.

For JP Model

Made for iPhone XS Max, iPhone XS, iPhone XR, iPhone X, iPhone 8, iPhone 8 Plus, iPhone 7, iPhone 7 Plus, iPhone SE, iPhone 6s, iPhone 6s Plus, iPhone 6, iPhone 6 Plus, iPhone 5s, iPad Pro 12.9-inch (2nd generation), iPad Pro 10.5-inch, iPad (6th generation), iPad (5th generation), iPad Pro 9.7-inch, iPad Pro 12.9-inch (1st generation), iPad Air 2, iPad mini 4, iPad mini 3, iPad Air, iPad mini 2, iPod touch (6th generation)

iPad, iPad Air, iPad Pro, iPhone are trademarks of Apple Inc., registered in the U.S. and other countries. The trademark “iPhone” is used in Japan with a license from Aiphone K.K.

Except for US, JP Model

Made for iPhone XS Max, iPhone XS, iPhone XR, iPhone X, iPhone 8, iPhone 8 Plus, iPhone 7, iPhone 7 Plus, iPhone SE, iPhone 6s, iPhone 6s Plus, iPhone 6, iPhone 6 Plus, iPhone 5s, iPad Pro 12.9-inch (2nd generation), iPad Pro 10.5-inch, iPad (6th generation), iPad (5th generation), iPad Pro 9.7-inch, iPad Pro 12.9-inch (1st generation), iPad Air 2, iPad mini 4, iPad mini 3, iPad Air, iPad mini 2, iPod touch (6th generation)

iPad, iPad Air, iPad Pro, iPhone are trademarks of Apple Inc., registered in the U.S. and other countries.

10. Revision History

Date	Content	Editor
2024/4/25	First release	Camille Pao
2024/5/8	Update Agency Compliance and Approvals section (Energy star 3.2)	Camille Pao



www.tscprinters.com