

TTP-243 Pro Series

■ Thermal Transfer ■ Direct Thermal
Desktop Barcode Printers



Series Lists:

TTP-243 Pro / 243E Pro / 342 Pro

TTP-243 Plus / 243E Plus / 342 Plus

User Manual

Copyright information

©2021 TSC Auto ID Technology Co., Ltd.

The copyright in this manual, the software and firmware in the printer described are owned by TSC Auto ID Technology Co., Ltd. All rights reserved.

CG Triumvirate is a trademark of Agfa Corporation. CG Triumvirate Bold Condensed font is under license from the Monotype Corporation. Windows is a registered trademark of Microsoft Corporation.

All other trademarks are the property of their respective owners. Information in this document is subject to change without notice and does not represent a commitment on the part of TSC Auto ID Technology Co. No part of this manual may be reproduced or transmitted in any form or by any means, for any purpose other than the purchaser's personal use, without the expressed written permission of TSC Auto ID Technology Co.



Table of Contents

1. Introduction	1
1.1 Effective Print Area	2
1.2 Available Bar Codes	3
1.3 Various Sensors	4
1.4 Supply Specification.....	6
1.4.1 Type of Paper	6
1.4.2 Media Specification.....	6
1.5 Ribbon Specification	8
2. Operation Overview.....	10
2.1 Unpacking and Inspection.....	10
2.2 Printer Overview	11
2.2.1 Front View	11
2.2.2 Interior View	12
2.2.3 Rear View.....	13
3. Setup.....	14
3.1 Setting up the Printer	14
3.2 Loading the Ribbon.....	15
3.3 Loading the Media	17

3.4 Peel-off Function.....	19
3.5 Install SD Memory Card (Option)	20
3.6 Install External Label Roll Mount (Not available for 243E series printer)	21
4. LED and Button Functions.....	22
4.1 LED Indication	22
4.2 Regular Button Function	23
4.3 Power-on Utilities.....	24
5. TSC Console.....	28
5.1 Start TSC Console.....	28
5.2 Printer Function	30
5.3 Setting Post-Print Action	31
6. Troubleshooting.....	32
7. Maintenance.....	32
8. Agency Compliance and Approvals	36
9. Revision History	37



1. Introduction

Thank you very much for purchasing TSC bar code printer.

TTP-243 series/ 243E series/ 342 series bar code printer. The attractive desktop printer delivers superior performance at an economical price. Both powerful and easy-to-use, this printer is your best choice among desktop direct thermal and thermal transfer label printers.

This document provides an easy reference for operating this printer. For system integration, the TSPL/TSPL2 printer programming manual or SDKs can be found on TSC website at: <https://www.tscprinters.com>.

1.1 Effective Print Area

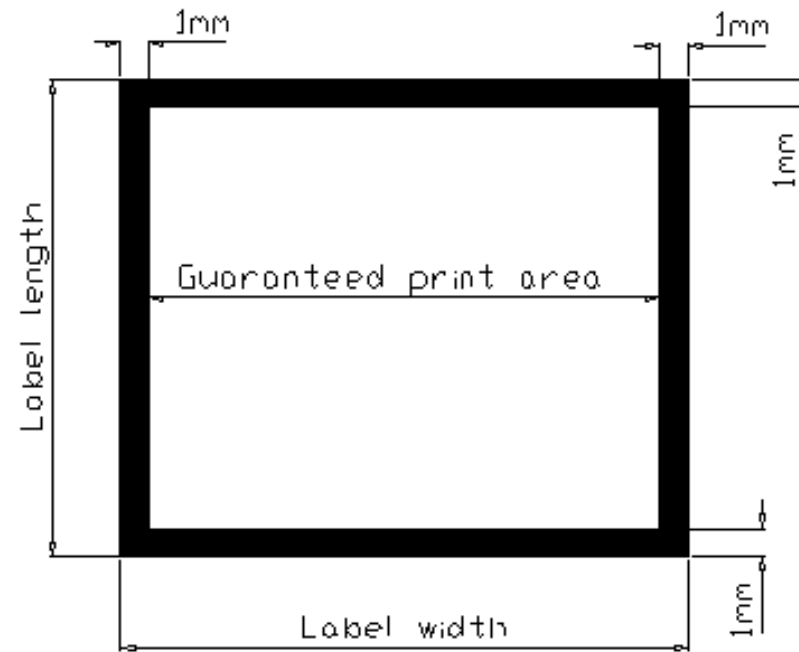

	203 DPI	300 DPI
Label/Ticket Print Length	12 mm~2286 mm	12 mm~1016 mm
Effective Print Length	10 mm~2284 mm	10 mm~1014 mm
Label/Ticket Print Width	25 mm~104 mm	
Effective Print Width	23 mm~102 mm	
No Print Area	1 mm	

1.2 Available Bar Codes

- 1D bar code
- Code 39
- Code 93
- Code 128 UCC
- Code 128, Subsets A, B, and C
- Codabar
- Interleaved 2 of 5
- EAN-8, EAN-13, EAN-128
- UPC-A, UPC-E
- EAN and UPC with 2 or 5 digits add-on
- MSI
- PLESSEY
- Postnet
- China post
- 2D bar code
- Maxicode
- PDF-417
- DataMatrix
- QR code
- GS1 DataBar family (RSS)

1.3 Various Sensors

Feed Gap Sensor

The feed gap sensor detects a label gap to locate the starting print position of the next label. The sensor is mounted 4 mm off the center line of the main mechanism.

In case of Label

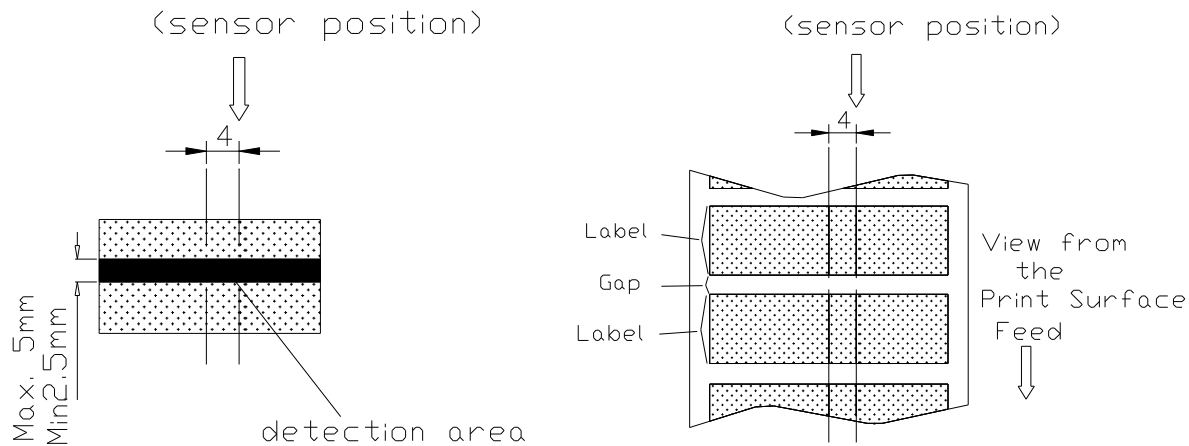

Black Mark Sensor

The black mark sensor locates the position of label by emitting infrared rays onto the black mark at the back of the ticket. The sensor is mounted 5.75 mm off the center line of the ticket roll width on the mechanism.

In case of Ticket

The default sensor position is (1) as shown on the figure below. To change to the (2) position, the customer should notify the manufacturer in advance. There can be only one position for the sensor. Once the sensor position is agreed upon, it cannot be changed afterwards.

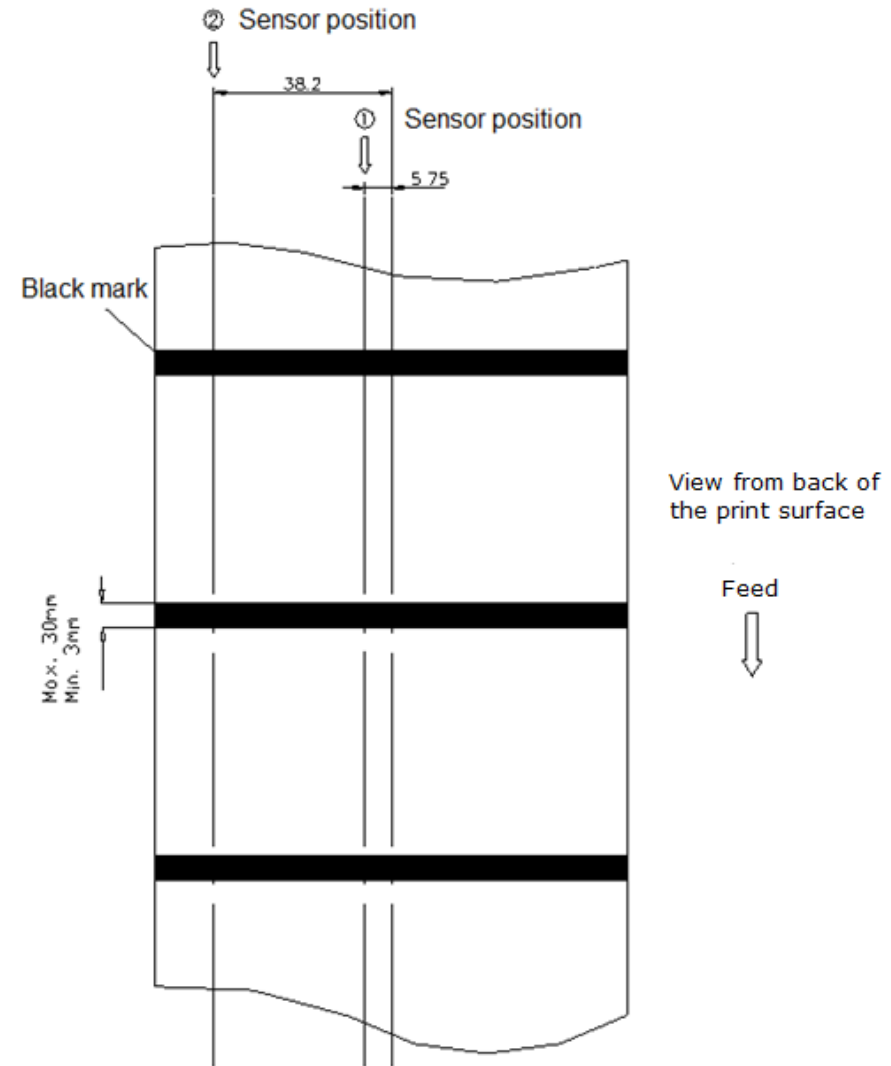

Ribbon End Sensor

The sensor detects the end portion of the ribbon. The ribbon end must be transparent.

Label End Sensor

The sensor detects the end portion of the label.

Peel off Sensor

The sensor detects the backing paper of a label.

Ribbon encoder

The encoder is used to detect if the ribbon is broken.

1.4 Supply Specification

1.4.1 Type of Paper

Two types of media are available: label and ticket.
There are two types of sensors for paper: gap sensor and black mark sensor.
Label and ticket can be further classified into direct thermal type or thermal transfer type.

1.4.2 Media Specification

Items	Label
Media Width	Max. 114mm Min. 25mm
Length (Pitch)	12 ~ 2286mm
Media Thickness	0.20 mm
Media Weight	Max 240 g/m ²
Max. Roll Diameter (1" core)	Inner roll diameter. Max 4.3" (110mm) External roll diameter. Max 8.4" (214mm)
Roll Up Method	Print surface wound outside as standard
Paper Core ID.	φ25.7±0.3mm

Note:

1. The width and thickness quoted above are said of the label plus its backing paper.
2. Likewise, the approval of label entails that of its backing paper.
3. In the peel off mode, the minimum pitch is 35mm.
4. In the cutter mode, it is required the paper be wound outside. Otherwise, paper jam tends to result.
5. In the cutter mode, the media thickness is 0.06 ~ 0.2 mm, the media weight is 100 g/m² at maximum, and the media types are receipt, tag, and label liner w/o glue.
Except for the linerless cutter, all TSC regular/heavy duty/care label cutters DO NOT cut on media with glue.
6. Paper shape is as shown on next page.
7. Tag is 0.2mm in thickness, and is less than 100g/m² in weight.

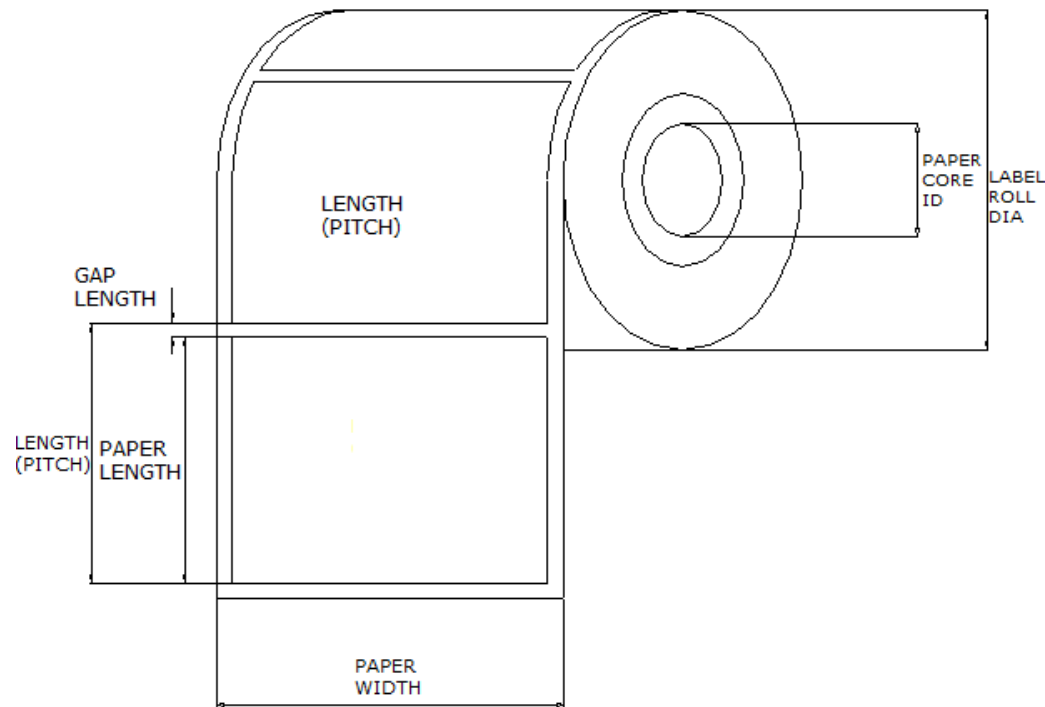

1.5 Ribbon Specification

Ribbon Specifications

Ribbon shape	Spool type
Ribbon width	Max. 110mm
Ribbon core inside diameter	Min. 40mm
Ribbon winding width	Max. 110mm
Ribbon wound type	Min. 40mm
Leading tape	Polyester film, 335±5mm long
End tape	Polyester film (transparent), 250±5mm long
Max. ribbon OD.	67mm
Winding method	Ink surface to be wound outside

Note: The maximum length of ribbon depends on its thickness and core outside diameter.

The formula below defines the correlation between ribbon roll length and ribbon core diameter.

$$L = \frac{(D^2 - d^2) \times \pi}{4t}, \text{ where}$$

L = Ribbon length

D = Max. roll diameter

d = Ribbon core outside diameter

t = Ribbon thickness

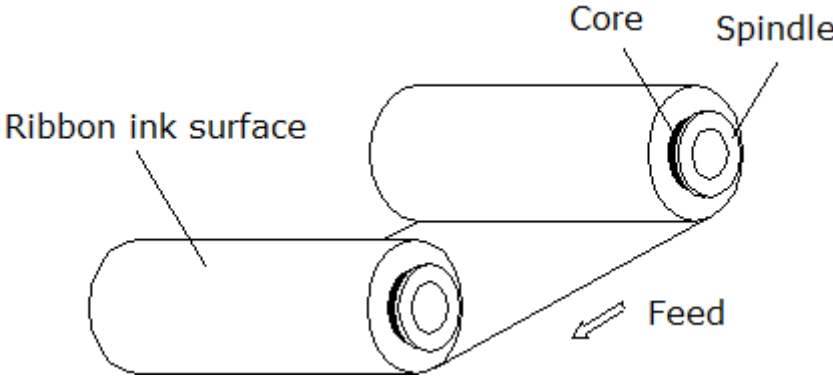

2. Operation Overview

2.1 Unpacking and Inspection

This printer has been specially packaged to withstand damage during shipping. Please carefully inspect the packaging and printer upon receiving the bar code printer. Please retain the packaging materials in case you need to reship the printer.

- One bar code printer unit
- One paper core for ribbon rewind spindle
- Two ribbon supply/rewind spindles
- One flat label supply roll spindle
- Two fixing tabs
- One round label supply roll spindle (Not available for 243E series printer)
- One Quick installation guide
- One power supply
- One power cord
- One USB interface cable (Pro series printer only)
- One Centronics interface cable (TTP-243 Plus & TTP-342 Plus series printer only)
- One sample roll of plain label stock (Not available for 243E series printer)
- One sample roll of wax-resin ribbon (Not available for 243E series printer)
- One external label roll mount (Not available for 243E series printer)

If any parts are missing, please contact the Customer Service Department of your purchased reseller or distributor.

2.2 Printer Overview

2.2.1 Front View

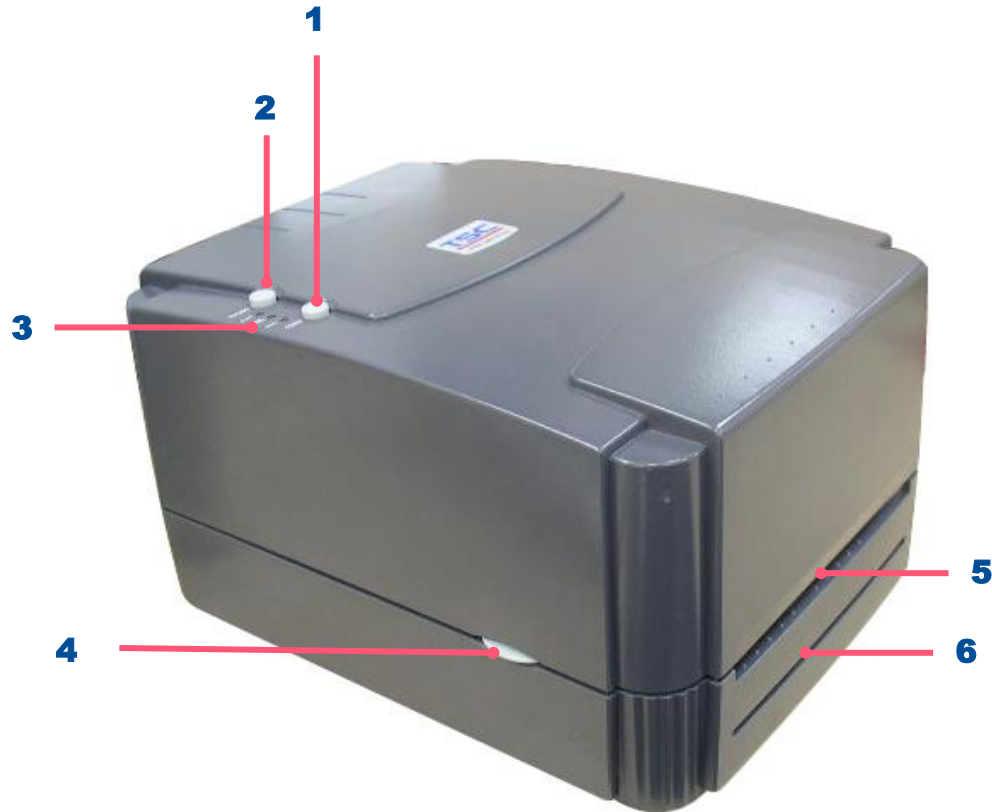

- 1.** FEED button
- 2.** PAUSE button
- 3.** PWR., ON-LINE and ERR. indicators
- 4.** Cover release button
- 5.** Label dispense opening
- 6.** Liner Opening (For use with peel-off function/
Not available for 243E series printer)

2.2.2 Interior View

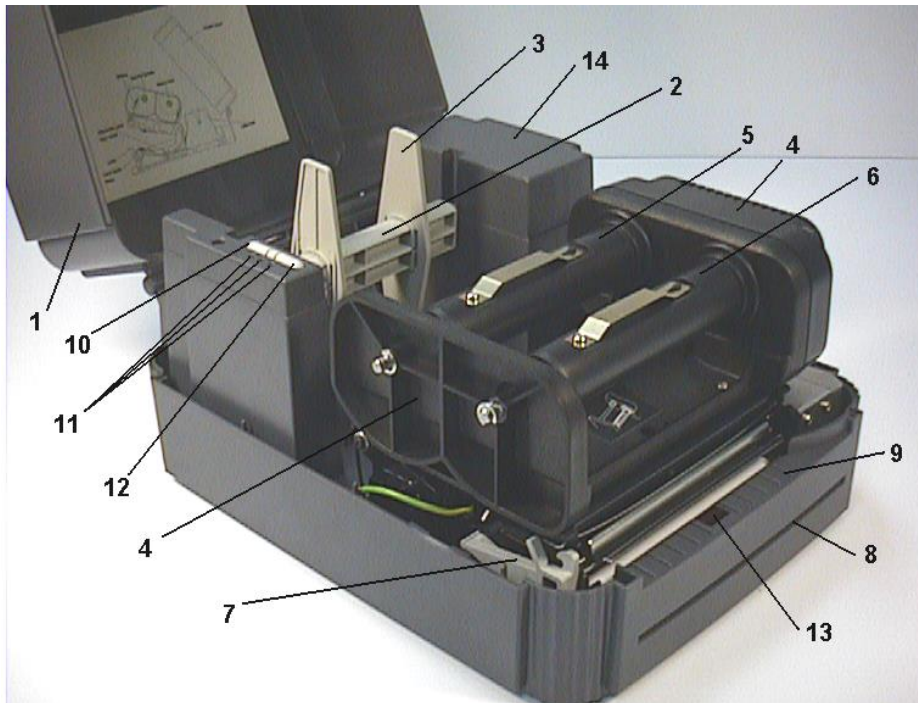

- 1.** Printer Cover (In open position)
- 2.** Label Supply Roll Spindle
- 3.** Fixing Tabs
- 4.** Ribbon Mechanism
- 5.** Ribbon Supply Spindle
- 6.** Ribbon Rewind Spindle
- 7.** Printer Carriage Release Lever
- 8.** Liner Opening
- 9.** Detachable Front Panel
- 10.** PAUSE Button
- 11.** PWR., ON-LINE, ERR. Indicators
- 12.** FEED Button
- 13.** Peel-off Sensor (Not available for 243E series printer)
- 14.** Memory Card Cover

2.2.3 Rear View

TTP-243 Plus/ 243E Plus/ 342 Plus series

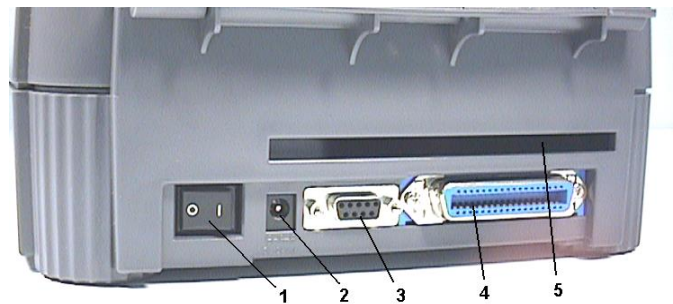

1. Power On/Off Switch
2. Power Supply Connector
3. RS-232C DB-9 Interface Connector
4. Centronics Interface Connector
5. Label Insert Opening (For use with external labels)

TTP-243 Pro/243E Pro/ 342 Pro series



1. Power On/Off Switch
2. Power Supply DC Jacket
3. RS-232C Interface Connector
4. USB Interface Connector
5. Label Insert Opening (For use with external media)
6. Centronics Interface Connector (Factory option)

3. Setup

3.1 Setting up the Printer



1. Open the printer top cover.
2. Place the printer on a flat surface.
3. Make sure the POWER switch is OFF.
4. Connect the printer to the computer with RS-232C or USB cable.



5. Plug the power cord into the power jacket at the rear of the printer, and then plug the power cord into a properly grounded receptacle.



Note: Please switch OFF the printer before plugging in the power cord to printer power jack.

3.2 Loading the Ribbon

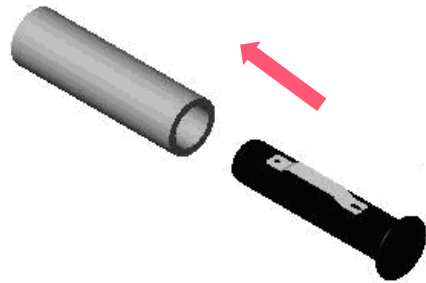

1. Place paper core on the ribbon rewind spindle.

2. Insert the left side first. Mount the ribbon rewind paper core on the front hubs.

Please be noted that the bigger hub side with 4 ribs must be installed toward the right side of ribbon mechanism.

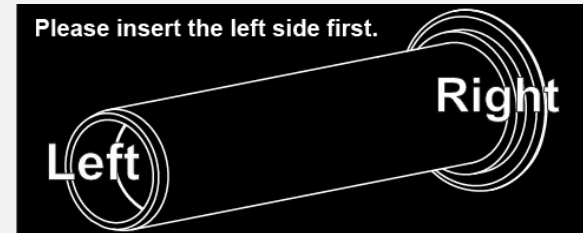
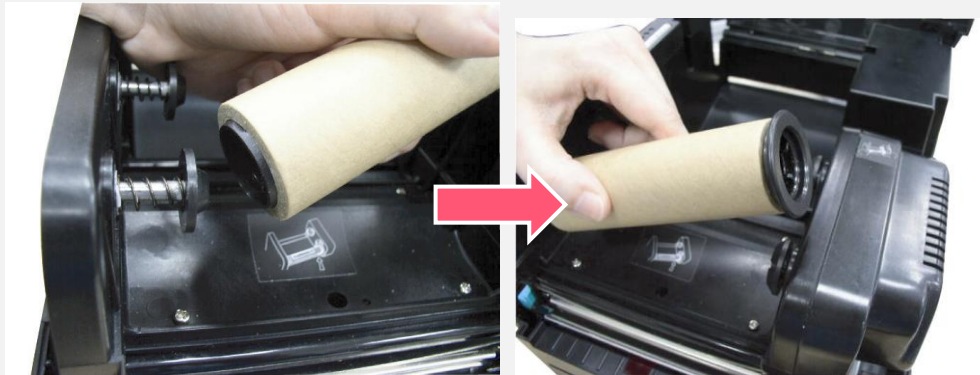

3. Install a ribbon on the ribbon supply spindle. Mount the ribbon supply spindle on the rear hubs.

Please be noted that the bigger hub side with 4 ribs must be installed toward the right side of ribbon mechanism.

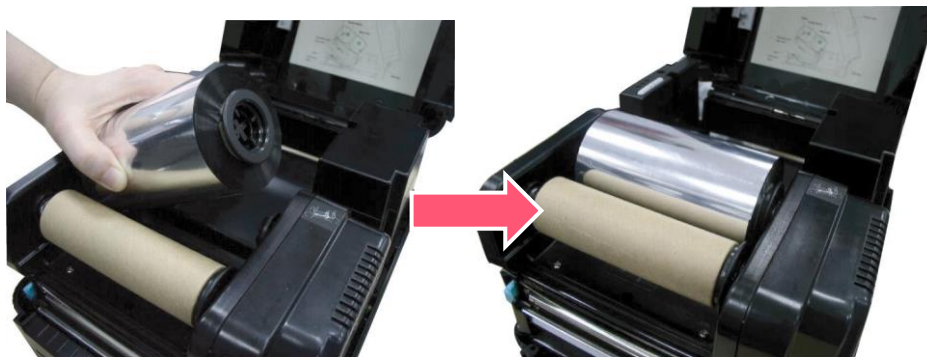

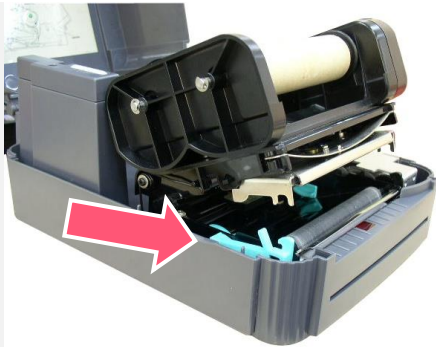

4. Disengage the printer carriage by pulling the carriage release lever forwards.



5. Following the direction of the ↓ **RIBBON** label, pull the transparent ribbon leader to the front from under the ribbon mechanism.



6. Attach the ribbon leader to the empty paper core on the ribbon rewind spindle (with a tape).



Note: Please install ribbon and media and close print head mechanism before turning on the power. Printer will determine direct thermal or thermal transfer mode automatically.

7. Rotate the ribbon rewind spindle until the ribbon overlaps the ribbon leader and stretches tight.
8. Close the printer carriage.
9. Close the printer cover and press the **FEED** button until the green **ON-LINE** LED illuminates.

3.3 Loading the Media

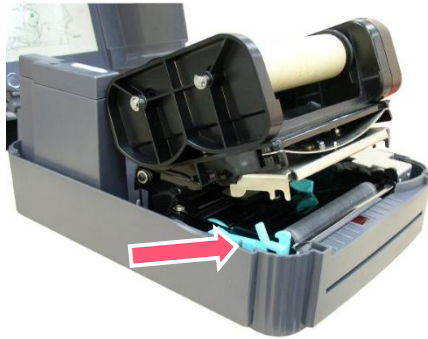

1. Open the printer cover.



2. Slide the label supply roll spindle through the core of a label roll and attach the fixing tabs onto the spindle.

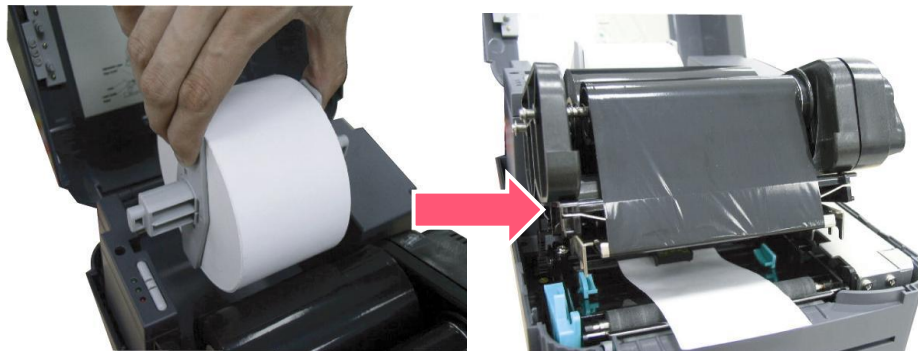

3. Place the label roll into the label roll mount. Feed the label under the carriage and over the platen.

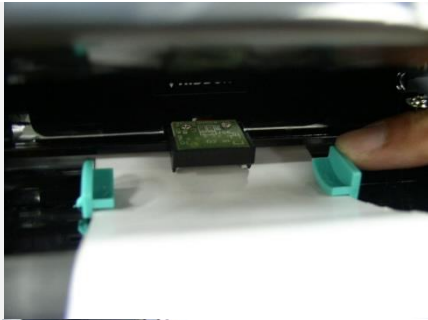

4. Adjust the label guide to fit the width of the media.



5. Following the direction of the ↓ **RIBBON** label, pull the transparent ribbon leader to the front from under the ribbon mechanism.

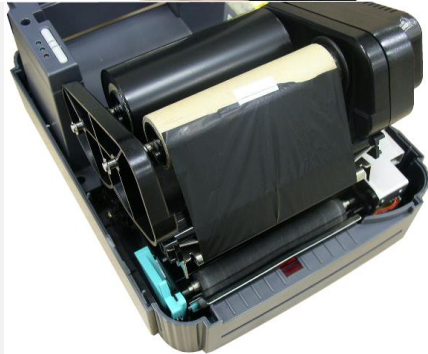

6. Close the printer carriage and the printer cover.

3.4 Peel-off Function



1. Remove the front panel.

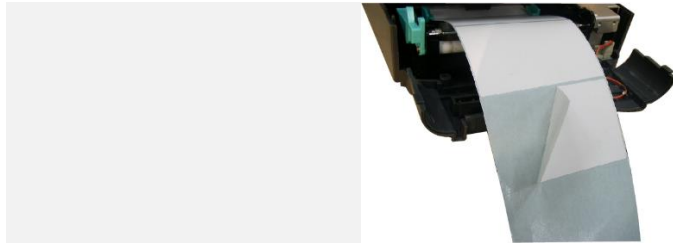

2. Remove the foremost one or two labels from the liner.



3. Pull the printer carriage release lever to feed the liner between the platen and the white peel-off roller.



4. Feed the liner through the liner opening in the front panel. Put back the front panel.

3.5 Install SD Memory Card (Option)



1. Open the memory card cover.



2. Make sure the direction of the memory card is correct

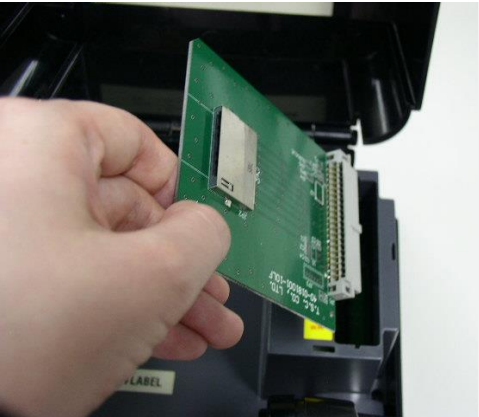

3. Plug in the SD memory card module on the main board.



4. Close the print head mechanism as indicated.

TTP-243 Plus/243E Plus/ 342 Plus series

TTP-243 Pro/243E Pro/ 342 Pro Series

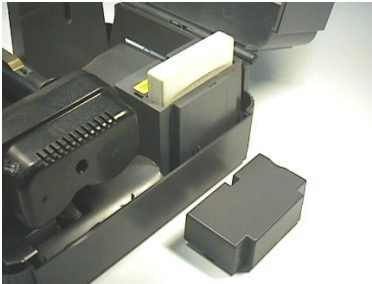

3.6 Install External Label Roll Mount (Not available for 243E series printer)

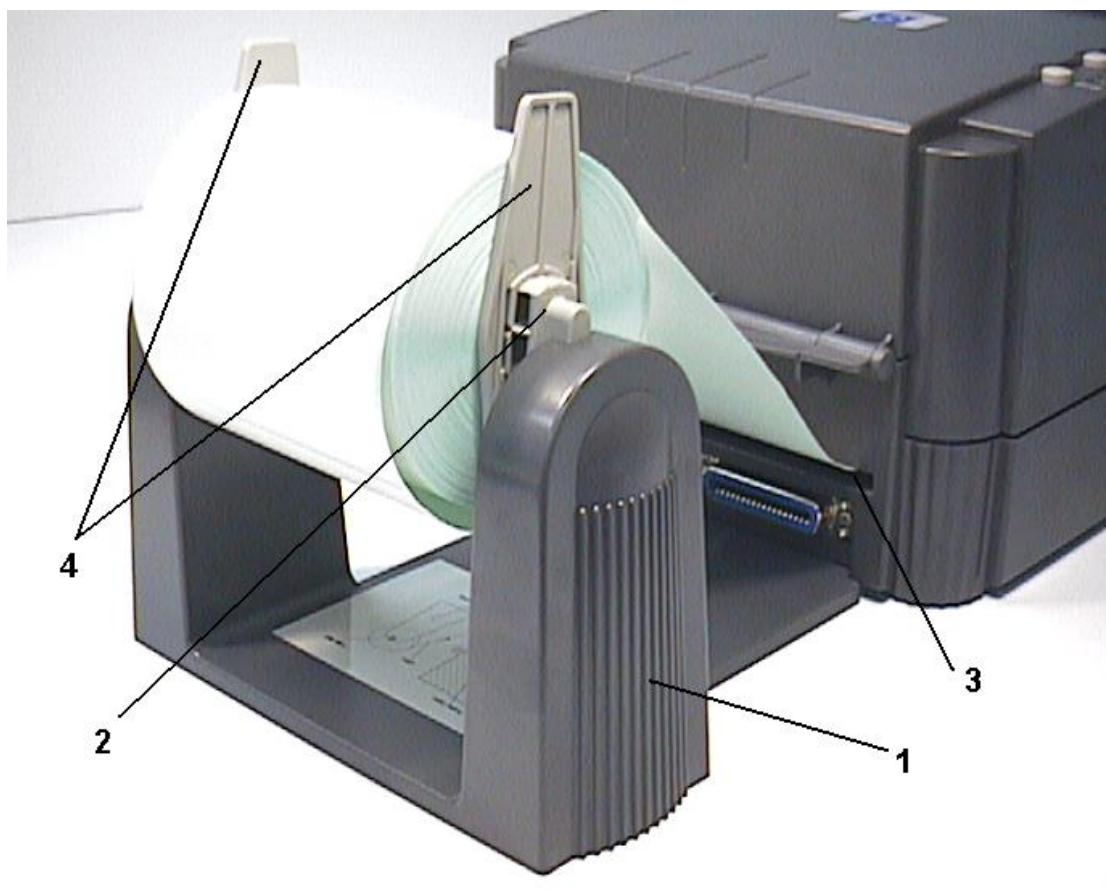

Installation of external label roll mount

1. External Label Roll Mount
2. Label Supply Roll Spindle
3. External Label Feed Opening
4. Fixing Tabs

4. LED and Button Functions

4.1 LED Indication

LED	Indication
PWR. (POWER) Indicator	The green PWR. indicator illuminates when the POWER switch is turned on.
ON-LINE Indicator	The green ON-LINE indicator illuminates when the printer is ready to print. When PAUSE button is pressed, the ON-LINE indicator flashes.
ERR. Indicator (Error/Paper Empty)	The red ERR. indicator illuminates in the event of a printer error, such as memory error, syntax error, and so forth.

4.2 Regular Button Function

Buttons

Function

PAUSE Button

The PAUSE button allows the user to stop or continue a print job.

By pressing the PAUSE button:

(1) the printer stops printing after printing label

(2) the PAUSE LED flashes

(3) the printer will hold all data in memory. This allows for trouble-free replacement of label stock and thermal transfer ribbon.

Press again the button will restart the printer.

Note: If the PAUSE button is held down for more than 3 seconds, the printer will be reset and all data of the previous printing job will be lost.

FEED Button

Press the FEED button to feed the label

4.3 Power-on Utilities

There are three power-on utilities to set up and test hardware. These utilities are activated by pressing the FEED or PAUSE button and turning on the printer power simultaneously. The utilities are listed as below:

- 1.** Self-test
- 2.** Gap sensor calibration
- 3.** Printer initialization

Self Test and Dump Mode

This utility is used to use self test function to see the setting of the printer. Please follow below steps to activate the function:

Install the label first > Press the **FEED** button>Turn on the printer power >The printer will perform the following items:

1. Calibrate label pitch
2. Print out thermal print head check pattern
3. Print the internal settings
4. Enter dump mode

Dump Mode

After the self test, the printer enters the dump mode. In this mode, any characters sent from the host computer will be printed in two columns. The characters received will be shown in the first column, and their corresponding hexadecimal values will be shown in the second column. Reset the printer by turning the POWER switch off and on.

ASCII Data →

```
*****
NOW IN DUMP MODE
DOWNLOAD "DE 44 4F 57 4E 4C 4F 41 44 20 22 44 45
MO2.BAS" S1 4D 4F 32 2E 42 41 53 22 0D 0A 53 49
ZE 4.00,5.00 5A 45 20 34 2E 30 30 2C 35 2E 30 30
CLS SPEED 0D 0A 43 4C 53 0D 0A 53 50 45 45 44
1.5 DENSIT 20 31 2E 35 0D 0A 44 45 4E 53 49 54
Y 10 DIRECT 59 20 31 30 0D 0A 44 49 52 45 43 54
ION 0 SET C 49 4F 4E 20 30 0D 0A 53 45 54 20 43
UTTER OFF S 55 54 54 45 52 20 4F 46 46 0D 0A 53
ET DEBUG LAB 45 54 20 44 45 42 55 47 20 4C 41 42
EL REFERENC 45 4C 0D 0A 52 45 46 45 52 45 4E 43
E 0,0 A=100 45 20 30 2C 30 0D 0A 41 3D 31 30 30
0 Y=100 FO 30 0D 0A 59 3D 31 30 30 0D 0A 46 4F
R I=1 TO 3 52 20 49 3D 31 20 54 4F 20 33 0D 0A
BARCODE 100, 42 41 52 43 4F 44 45 20 31 30 30 2C
Y."39".96,1, 59 2C 22 33 39 22 2C 39 36 2C 31 2C
0.2.4,STR$(A 30 2C 32 2C 34 2C 53 54 52 24 28 41
) A=A+1 Y= 29 0D 0A 41 3D 41 2B 31 0D 0A 59 3D
Y+150 NEXT 59 2B 31 35 30 0D 0A 4E 45 58 54 0D
PRINT 1 EO 0A 50 52 49 4E 54 20 31 0D 0A 45 4F
P DEMO2 50 0D 0A 44 45 4D 4F 32 0D 0A
```

← Hex decimal data related to left column of ASCII data

Gap Sensor Calibration Utility

This utility is used to calibrate the sensitivity of gap sensor. Please follow the steps below to calibrate gap sensor:

- 1. Turn off the printer power > install blank labels > Hold the **PAUSE** button > Turn on printer power.**
- 2. Release **PAUSE** button when printer feeds labels > Do not turn off printer until the printer stops and two green LED lights on.**

Note: Black mark sensor has fixed sensitivity. It is no need to calibrate the black mark sensor

Printer Initialization

Printer initialization sets printer parameters to default values. And it will not clear downloaded files resident in flash memory.

Please follow the steps below to initialize the printer:

- 1. Turn off the printer power > Hold down the **PAUSE** and **FEED** buttons > Turn on the printer.**
- 2. Do not release the buttons until the three LED flash in turn.**

Note: Printing method (thermal transfer or thermal direct printing) will be set automatically at the activation of printer power. When printer initialization is done, sensor sensitivity will be reset to default. Sensor calibration is required before printing labels.

Printer configuration will be restored to defaults as below after initialization.

Parameter	Default setting
Speed	200 dpi: 50.8 mm/sec (2 ips) 300 dpi: 38.1 mm/sec (1.5 ips)
Density	8
Media Width	4"(101.6 mm)
Media Height	4"(101.6 mm)
Sensor Type	Gap sensor
Gap Setting	0.12" (3.0 mm)
Print Direction	0
Reference Point	0,0 (upper left corner)
Offset	0
Post-Print Action	On
Serial Port Settings	Off
Code Page	Off
Country Code	9600 bps, none parity, 8 data bits, 1 stop bit
Clear Flash Memory	850

5. TSC Console

TSC Console is a management tool combining the Printer Management, Diagnostic Tool, CommTool and Printer Webpage settings, which enables you to adjust printer's settings/status; change printers' settings; download graphics, deploy fonts, graphics, label templates or upgrade the firmware to the group of printers, and send additional commands to printers at the same time.

※ **Printer firmware version before A2.12 will only use 9100 Port as command port; Printer firmware after A2.12 will use 6101 Port as command port.**

5.1 Start TSC Console

1. Double click TSC Console icon to start the software.

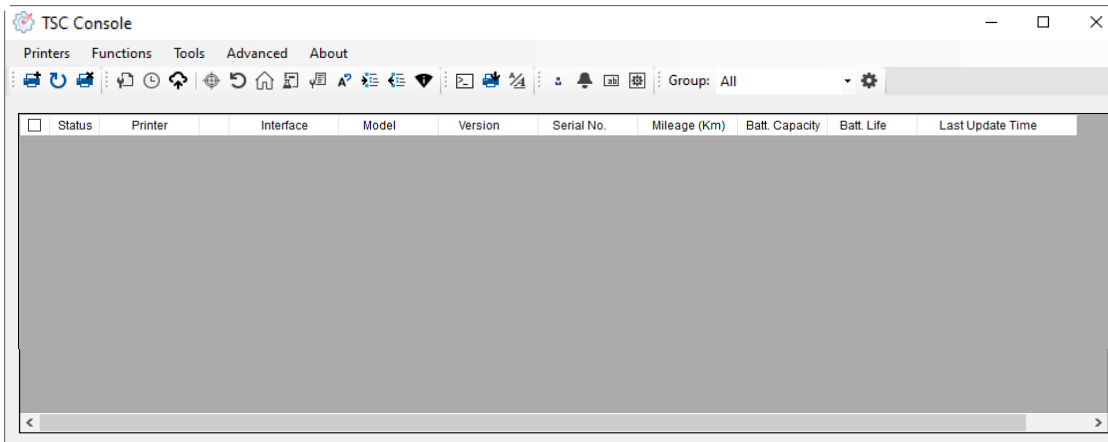

2. Manually add the devices by clicking **Printer > Add Printers**.

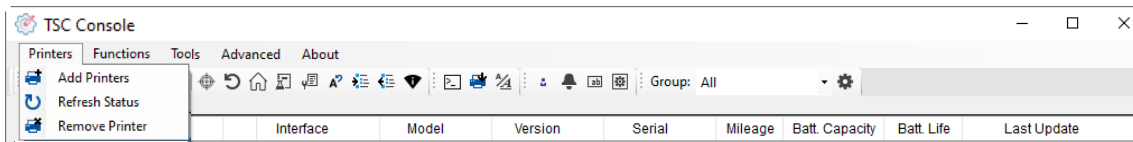

3. Select the current interface of the printer.

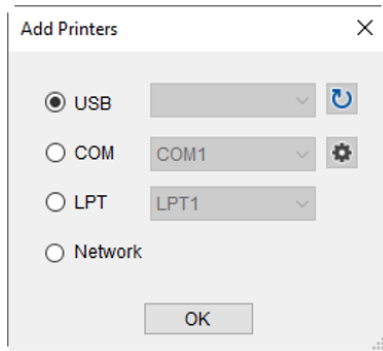

4. The printer will be added to **TSC Console**'s interface.

5. Select the printer and set the settings.

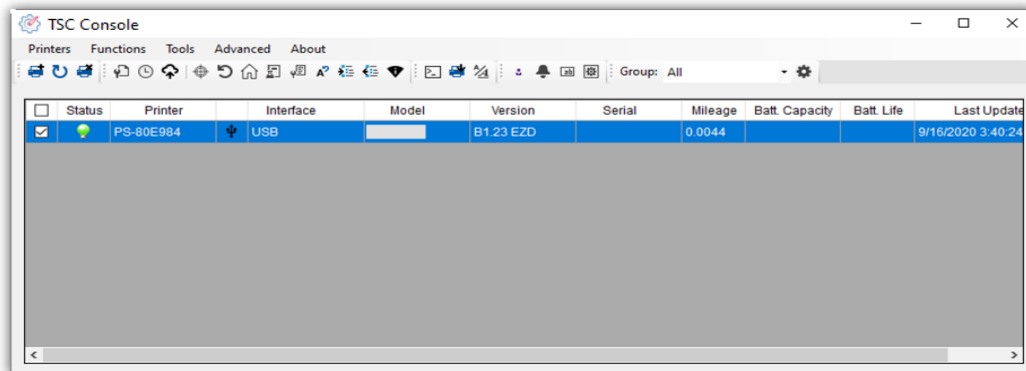

For more information, please refer to **TSC Console User Manual**.

5.2 Printer Function

Printer Function could be found in **Printer Configuration**. “Printer Function” will be shown on the left side of the window.

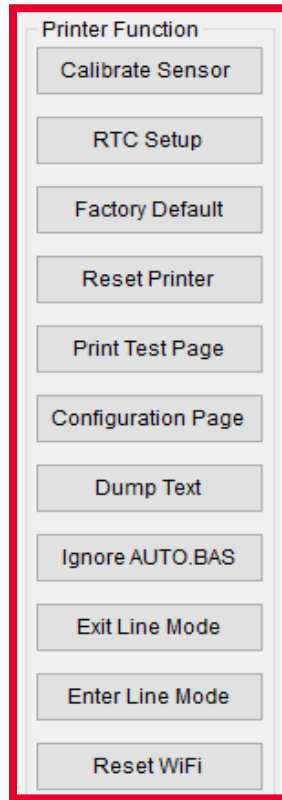

Functions	Description
Calibrate Sensor	Detect media types and the size of the label
RTC Setup	Synchronize printer with Real Time Clock on PC
Factory Default	Initialize the printer to default settings
Reset Printer	Reboot printer
Print Test Page	Print test page according to the specified label size and sensor type.
Configuration Page	Print printer configurations
Dump Text	Activate the printer to dump mode
Ignore AUTO.BAS	Restart the printer and Ignore the AUTO.BAS file for once
Exit Line Mode	Exit the line mode to page mode
Enter Line Mode	Leave page mode and enter line mode
Reset WiFi	Restore the WiFi settings to defaults.

5.3 Setting Post-Print Action

When the printer is equipped with other option kits, ex: cutter, peeler, rewinder, please select the mode after finishing the calibration.

Follow below procedure to set the post action for the printing:

Refer Ch. 5.1 to connect the printer with **TSC Console** > **Double click** the printer > **Printer Configuration Page** will pop up > Click **Get** to load information > Go to **Common Tab** > Find **Post-Print Action** > **Select the mode** for the application > Click **Set** to finish setting.

Printer Configuration

Printer Configuration Emulation TPH Care Smart Battery Unit: mm

Printer Function

- Calibration
- RTC Setup
- Factory Default
- Reset Printer
- Print Test Page
- Configuration Page
- Dump Text
- Ignore AUTO.BAS
- Exit Line Mode
- Enter Line Mode
- Wi-Fi Default
- Get Status

Printer Configuration

Version: []
Serial No.: [] TPH Serial Number: N/A
Checksum: 1344B9B1 TPH Odometer: N/A
Ribbon Remaining: [] % Cutter Serial Number: N/A
Label Count: 553
Cutting Counter: 0 0 Reset
Mileage (Km): 0.0913 0.0913 Reset

Common RS-232 Bluetooth Wi-Fi Ethernet SMTP SNTP

Speed: 3 Ribbon: OFF
Density: 8 Ribbon Sensor: OFF
Paper Width: 104.00 mm Ribbon Encoder Err.: OFF
Paper Height: 74.05 mm Head-up Sensor: ON
Media Sensor: Black Mark Reprint After Error: ON
Gap: 1.99 0.00 mm Maximum Length: 152.25 mm
Post-Print Action: [] Gap Inten.: 7
Reference: OFF Bline Inten.: 7
Direction: TEAR Continuous Inten.: 4
Offset: PEEL Threshold Detection: AUTO
Shift X: CUTTER Print Quality: STANDARD
Shift Y: REWIND Standby Time: 120 secs
Code Page: 850 Sleep Time: 0 mins
Country Code: 001 (1~65534, 0: OFF)
(10~65534, 0: OFF)

Save Load

Set Get

6. Troubleshooting

Problem	Solution
<p>Ribbon does not advance or rewind</p>	<ul style="list-style-type: none"> - The media and ribbon must be installed then engage the print head mechanism prior to turning on printer power. - Install the black ribbon spindle at the correct direction. - Please check the "Media settings method" in the driver if it is set to direct thermal mode.
<p>Poor print quality</p>	<ul style="list-style-type: none"> - Clean the thermal print head. - Adjust the print density setting. - Ribbon and media are not compatible. - Media thickness is over spec. - Check if correct power supply is connected with printer.
<p>Power indicator on printer does not illuminate</p>	<ul style="list-style-type: none"> - Check the power cord, see whether it is properly connected. - Check if the LED on the power supply is illuminated. If it is not lit on, then the power supply is damaged. - Check if correct power supply is connected with printer.
<p>ON-LINE indicator is off, ERR. indicator is on</p>	<ul style="list-style-type: none"> - Out of paper or out of ribbon <p>If there is one beep sound when printer is error, then it's gap sensor problem. Please check the following items.</p> <ol style="list-style-type: none"> (1) Calibrate gap sensor or setup the paper length in labeling software/program properly. (2). Install the paper at the correct <p>If there are two beeps sound when printer is error then it's ribbon sensor problem. Please check the following items.</p> <p>Is outside wound ribbon is used with this printer?</p>

Is ribbon threaded correctly in the mechanism?

Is paper core installed on the ribbon take up spindle?

- Calibrate the sensitivity of gap sensor.
- Check the driver or command script setting if sensor type is set properly.
- Calibrate the gap sensor again if die cut media is used for printing.

Continuous feeding when printing labels

7. Maintenance

This session presents the clean tools and methods to maintain the printer.

■ For Cleaning

Depending on the media used, the printer may accumulate residues (media dust, adhesives, etc.) as a by-product of normal printing. To maintain the best printing quality, you should remove these residues by cleaning the printer periodically. Regularly clean the print head and supply sensors once change a new media to keep the printer at the optimized performance and extend printer life.

■ For Disinfecting

Sanitize your printer to protect yourself and others and can help prevent the spread of viruses.

■ Important

- Set the printer power switch to O (Off) prior to performing any cleaning or disinfecting tasks. Leave the power cord connected to keep the printer grounded and to reduce the risk of electrostatic damage.
- Do not wear rings or other metallic objects while cleaning any interior area of the printer.
- Use only the cleaning agents recommended in this document. Use of other agents may damage the printer and void its warranty.
- Do not spray or drip liquid cleaning solutions directly into the printer. Apply the solution on a clean lint-free cloth and then apply the dampened cloth to the printer.
- Do not use canned air in the interior of the printer as it can blow dust and debris onto sensors and other critical components.
- Only use a vacuum cleaner with a nozzle and hose that are conductive and grounded to drain off static build up.
- All reference in these procedures for use of isopropyl alcohol requires that a 99% or greater isopropyl alcohol content be used to reduce the risk of moisture corrosion to the printhead.
- Do not touch printhead by hand. If you touch it carelessly, please use 99% Isopropyl alcohol to clean it.
- Always taking personal precaution when using any cleaning agent.

Cleaning Tools

- Cotton swab
- Lint-free cloth
- Brush with soft non-metallic bristles
- Vacuum cleaner
- 75% Ethanol (for disinfecting)
- 99% Isopropyl alcohol (for printhead and platen roller cleaning)
- Genuine printhead cleaning pen
- Mild detergent (without chlorine)

Cleaning Process:

Printer Part	Method	Interval
Print Head	<ol style="list-style-type: none"> I. Always turn off the printer before cleaning the printhead. II. Allow the printhead to cool for at least one minute. III. Use a cotton swab and 99% Isopropyl Alcohol or genuine print head cleaning pen to clean the print head surface. 	Clean the print head when changing a new label roll.
Platen Roller	<ol style="list-style-type: none"> I. Turn off the printer. II. Rotate the platen roller and wipe it thoroughly with the lint-free 99% Isopropyl Alcohol. 	Clean the platen roller when changing a new label roll
Peel Bar	Use the lint-free cloth with 99% Isopropyl Alcohol to wipe it.	As needed
Sensor	Use brush with soft non-metallic bristles or a vacuum cleaner, to remove paper dust. Clean upper and lower media sensors to ensure reliable Top of Form and Paper Out sensing.	Monthly
Exterior	Clean the exterior surfaces with a clean, lint-free cloth (water-dampened cloth). If necessary, use a mild detergent or desktop cleaning solution then use the 75% Ethanol to wipe it.	As needed
Interior	Clean the interior of the printer by removing any dirt and lint with a vacuum cleaner, as described above, or use a brush with soft non-metallic bristles then use the 75% Ethanol to wipe it.	As needed

8. Agency Compliance and Approvals

CE Class A, FCC Class A, C-Tick Class A, TÜV/Safety, CCC

WARNING

1. HAZARDOUS MOVING PARTS IN CUTTER MODULE. KEEP FINGER AND OTHER BODY PARTS AWAY.
2. THE MAIN BOARD INCLUDES REAL TIME CLOCK FEATURE HAS LITHIUM BATTERY CR2032 INSTALLED. RISK OF EXPLOSION IF BATTERY IS REPLACED BY AN INCORRECT TYPE.
3. DISPOSE OF USED BATTERIES ACCORDING TO THE INSTRUCTIONS.

此為 A 級產品，在生活環境中，該產品可能會造成無線電干擾。在這種情況下，可能需要使用者對干擾採取切實可行的措施。

A 급기기

(업무용 정보통신기기)

이 기기는 업무용으로 전자파 적합등록을 한 기기이오니, 판매자 또는 사용자는 이 점을 주의하시기 바라며, 만약 잘못 판매 또는 구입하였을 때에는 가정용으로 교환하시기 바랍니다.

9. Revision History

Date	Content	Editor
2023/8/11	Modify 2.1 Unpacking and Inspection section	Camille

TSC **PRINTRONIX**[®]
AUTO ID