

Desktop Barcode Printer

DA210 Series

Direct Thermal

Series Models

DA210 / DA310

DA220 / DA320

DA220HC / DA320HC



User Manual

Copyright

©2024 TSC Auto ID Technology Co., Ltd.

The copyright in this manual, the software and firmware in the printer described are owned by TSC Auto ID Technology Co., Ltd. All rights reserved.

CG Triumvirate is a trademark of Agfa Corporation. CG Triumvirate Bold Condensed font is under license from the Monotype Corporation. Windows is a registered trademark of Microsoft Corporation.

All other trademarks are the property of their respective owners. Information in this document is subject to change without notice and does not represent a commitment on the part of TSC Auto ID Technology Co. No part of this manual may be reproduced or transmitted in any form or by any means, for any purpose other than the purchaser's personal use, without the expressed written permission of TSC Auto ID Technology Co.

Table of Contents

- 1 Introduction..... 4**
 - 1.1 Key Features.....4
 - 1.2 Product Specification.....6

- 2 Operation Overview..... 12**
 - 2.1 Unpacking and Inspection12

- 3 Getting to Know Your Printer..... 13**
 - 3.1 Front View.....13
 - 3.2 Interior View14
 - 3.3 Rear View15

- 4 Setup 16**
 - 4.1 Setting up the Printer.....16
 - 4.2 Loading the Media.....17
 - 4.3 Loading the External Media.....18
 - 4.4 Loading Media in Peel-off Mode (Optional for DA220 series)19
 - 4.5 Loading the Media in Cutter Mode (Optional for DA220 series)20
 - 4.6 Loading Media in Linerless Tear Mode (Optional for DA220 series)21
 - 4.7 Loading Media in Linerless Cutter Mode (Optional for DA220 series).....22
 - 4.8 Install the Adapter for 1.5” Paper Core (Optional).....23

- 5 LED and Button Functions..... 24**
 - 5.1 LED Indicator24
 - 5.2 Regular Button Function.....24
 - 5.3 Power-on Utilities25

- 6 TSC Console 26**

- 6.1 Starting TSC Console.....26
- 6.2 Setup Ethernet Interface28
- 6.3 TPH Care30
- 6.4 Printer Function.....31
- 6.5 Setting Post-Print Action32

- 7 Troubleshooting 33**

- 8 Maintenance..... 36**
- 8.1 Cleaning Supplies37
- 8.2 Cleaning Procedures.....38

- 9 Agency Compliance and Approvals..... 39**

- Revision History..... 46**

1 Introduction

Thank you very much for purchasing TSC barcode printer.

The DA Series of direct thermal desktop printers is ideal for a wide variety of applications including product marking, point of sale, retail, small office, shipping labels, and other labeling and tag applications at a very competitive price.

The DA Series is a perfect combination of affordability with a durable and reliable design. The DA series offers both 203 and 300 dpi print resolution with printing speeds up to a fast 6 ips. The large 60-watt power supply produces high-quality printed labels, even at its fastest print speeds.

1.1 Key Features

Affordable

The affordable DA210 and DA310 models are priced right and have the features you need for most basic label printing needs using a USB 2.0 or optional Bluetooth interface.

Wireless and Hardware Communications

Need more communications power? The DA220 and DA320 models have more memory and support nearly every major communications option including Serial RS-232, Ethernet, USB, USB host, internal 802.11 a/b/g/n wireless, or internal Bluetooth.

Emulations and More

The DA220 and DA320 models have plenty of memory with 128 MB Flash & 64 MB SDRAM that can be used for easy storage of fonts, international character sets, and graphics. Right out of the box, it supports a fully compatible set of standard industry emulations as well as multiple printer languages, making it easy to replace old installed hardware.

Easy Loading

For easy loading, the DA Series employs a user-friendly double-wall clamshell design with a large 5-inch (outside diameter) center-biased media bay. The spring-loaded label roll holder makes loading simple. Top-of-form sensing by gap, black mark, or notch is standard. The printer also comes with a head-open sensor.

This document provides an easy reference for operating this printer. For system integration, the TSPL/TSPL2 printer programming manual or SDKs can be found on TSC website at: <https://www.tscprinters.com>.

1.2 Product Specification

DA210 / DA220 Series

Model	DA210	DA310	DA220	DA320
Resolution	8 dots/mm (203 dpi)	12 dots/mm (300 dpi)	8 dots/mm (203 dpi)	12 dots/mm (300 dpi)
Printing Method	Direct Thermal			
Max. Print Speed	152.4 mm (6")/second	102 mm (4")/second	152.4 mm (6")/second	102 mm (4")/second
Max. Print Width	108 mm (4.25")	105.7 mm (4.16")	108 mm (4.25")	105.7 mm (4.16")
Max. Print Length	2,794 mm (110")	1,016 mm (40")	25,400 mm (1000")	11,430 mm (450")
Enclosure	Double-walled plastic			
Physical Dimension	172 mm (W) x 165 mm (H) x 195 mm (D) 6.77" (W) x 6.50" (H) x 7.68" (D)			
Weight	1.5 kg (3.31 lbs.)			
Label Roll Capacity	127 mm (5") O.D.			
Processor	32-bit RISC CPU			
Memory	<ul style="list-style-type: none"> • 8 MB Flash memory • 16 MB DRAM 		<ul style="list-style-type: none"> • 128 MB Flash memory • 64 MB DRAM 	
Interface	<ul style="list-style-type: none"> • USB 2.0 (high speed mode) • Internal Bluetooth (factory option) 		<ul style="list-style-type: none"> • PCBA1: USB 2.0 high speed mode, USB Host, RS-232 and Ethernet (standard) • PCBA2: USB 2.0 and Ethernet (factory option) • Internal 802.11 a/b/g/n wireless (factory option) • Internal Bluetooth (factory option) 	
Power	External universal switching power supply <ul style="list-style-type: none"> • Input: AC 100-240V, 2.0A, 50-60Hz • Output: DC 24V, 2.5A, 60W 			
User Interface	1 power switch, 1 feed button, 1 LED (3 colors: green, amber & red)			

Model	DA210	DA310	DA220	DA320
Sensors	<ul style="list-style-type: none"> • Transmissive gap sensor • Black mark reflective sensor • Head open sensor 			
Internal Fonts	<ul style="list-style-type: none"> • 8 alpha-numeric bitmap fonts • Monotype Image® true type font engine with one CG Triumvirate Bold Condensed scalable font 			
Barcode	<ul style="list-style-type: none"> • 1D barcode Code 39, Code 93, Code128UCC, Code128 subsets A.B.C, Codabar, Interleaved 2 of 5, EAN 8, EAN 13, EAN 128, UPC-A, UPC-E, EAN and UPC 2(5) digits add-on, MSI, PLESSEY, POSTNET, China post, ITF14, EAN14, Code 11, TELEPEN, TELEPENN, PLANET, Code 49, Deutsche Post Identcode, Deutsche Post Leitcode, LOGMARS • 2D barcode TLC39, CODABLOCK F mode, PDF-417, Maxicode, DataMatrix, QR code, Aztec, Micro PDF 417, GS1 DataBar (RSS barcode) 			
Font and Barcode Rotation	0, 90, 180, 270 degree			
Printer Language	TSPL-EZD (Compatible with EPL, ZPL, ZPL II, DPL)			
Media Type	Continuous, black mark, fan-fold, notched (outside wound)			
Media Width	19 mm - 114 mm (0.7" - 4.5")			
Media Thickness	0.055 mm - 0.19 mm (2.16 mil - 7.48 mil)			
Media Core Diameter	25.4 mm - 38 mm (1" - 1.5")			
Label Length	10 mm - 2,794 mm (0.39" - 110")	10 mm - 1,016 mm (0.39" - 40")	10 mm - 25,400 mm (0.39" - 1000")	10 mm - 11,430 mm (0.39" - 450")
Environment Condition	<ul style="list-style-type: none"> • Operation: 5°C to 40°C (41°F to 104°F), 25% - 85% non-condensing • Storage: -40°C to 60°C (-40°F to 140°F), 10% - 90% non-condensing 			
Accessories	<ul style="list-style-type: none"> • Quick start guide • USB cable • Power cord • External universal switching power supply 			

Model	DA210	DA310	DA220	DA320
Factory Options	<ul style="list-style-type: none"> • Internal Bluetooth • Internal MFi Bluetooth 		<ul style="list-style-type: none"> • Real Time Clock • Internal 802.11 a/b/g/n wireless • Internal Bluetooth • Internal MFi Bluetooth • PCBA2: USB2.0 and Ethernet 	
Dealer Options		N/A	<ul style="list-style-type: none"> • Peel-off module • Guillotine cutter (full cut or partial cut) • Linerless with cutter • Linerless with tear 	
User Options	<ul style="list-style-type: none"> • 1.5" adaptor for 1.5" paper core • External roll mount, media O.D. 214 mm (8.4") with 76.2 mm (3") core 		<ul style="list-style-type: none"> • 1.5" adaptor for 1.5" paper core • External roll mount, media O.D. 214 mm (8.4") with 76.2 mm (3") core • KP-200 Plus keyboard display unit (serial interface) 	

DA220HC/DA320HC Series (Models for Healthcare Applications)

Model	DA220HC	DA320HC
Resolution	8 dots/mm (203 dpi)	12 dots/mm (300 dpi)
Printing Method	Direct Thermal	
Max. Print Speed	152.4 mm (6")/second	102 mm (4")/second
Max. Print Width	108 mm (4.25")	105.7 mm (4.16")
Enclosure	<ul style="list-style-type: none"> • Double-walled plastic • Disinfectant-ready plastic • Antibacterial enclosure 	
Physical Dimension	172 mm (W) x 165 mm (H) x 195 mm (D) 6.77" (W) x 6.50" (H) x 7.68" (D)	
Weight	1.5 kg (3.31 lbs.)	
Label Roll Capacity	127 mm (5") O.D.	
Processor	32-bit RISC CPU	
Memory	<ul style="list-style-type: none"> • 128 MB Flash memory • 64 MB DRAM 	
Interface	<ul style="list-style-type: none"> • PCBA1: USB 2.0 high speed mode, USB Host, RS-232 and Ethernet (standard) • PCBA2: USB 2.0 and Ethernet (factory option) 	
Power	External universal switching power supply <ul style="list-style-type: none"> • IEC 60601-1 certified power supply • Input: AC 100-240V, 2.0A, 50-60Hz • Output: DC 24V, 2.5A, 60W 	
User Interface	1 power switch, 1 feed button, 1 LED (3 colors: green, amber & red)	
Sensors	<ul style="list-style-type: none"> • Transmissive gap sensor • Black mark reflective sensor • Head open sensor 	
Real Time Clock	Standard	

Model	DA220HC	DA320HC
Internal Fonts	<ul style="list-style-type: none"> • 8 alpha-numeric bitmap fonts • Monotype Image® true type font engine with one CG Triumvirate Bold Condensed scalable font 	
Barcode	<ul style="list-style-type: none"> • 1D barcode Code 39, Code 93, Code128UCC, Code128 subsets A.B.C, Codabar, Interleaved 2 of 5, EAN 8, EAN 13, EAN 128, UPC-A, UPC-E, EAN and UPC 2(5) digits add-on, MSI, PLESSEY, POSTNET, China post, ITF14, EAN14, Code 11, TELEPEN, TELEPENN, PLANET, Code 49, Deutsche Post Identcode, Deutsche Post Leitcode, LOGMARS • 2D barcode TLC39, CODABLOCK F mode, PDF-417, Maxicode, DataMatrix, QR code, Aztec, Micro PDF 417, GS1 DataBar (RSS barcode) 	
Font and Barcode Rotation	0, 90, 180, 270 degree	
Printer Language	TSPL-EZD (Compatible with EPL, ZPL, ZPL II, DPL)	
Media Type	Continuous, black mark, fan-fold, notched (outside wound)	
Media Width	19 mm - 114 mm (0.7" - 4.5")	
Media Thickness	0.055 mm - 0.19 mm (2.16 mil - 7.48 mil)	
Media Core Diameter	25.4 mm - 38 mm (1" - 1.5")	
Label Length	10 mm - 25,400 mm (0.39" - 1,000")	10 mm - 11,430 mm (0.39" - 450")
Environment Condition	Operation: 5°C to 40°C (41°F to 104°F), 25% - 85% non-condensing Storage: -40°C to 60°C (-40°F to 140°F), 10% - 90% non-condensing	
Accessories	<ul style="list-style-type: none"> • Quick start guide • USB cable • Power cord • External universal switching power supply 	
Factory Options	<ul style="list-style-type: none"> • Internal 802.11 a/b/g/n wireless • Internal Bluetooth • Internal MFi Bluetooth 	

Model	DA220HC	DA320HC
	<ul style="list-style-type: none"> • PCBA2: USB 2.0 and Ethernet 	
Dealer Options	<ul style="list-style-type: none"> • Peel-off module • Guillotine cutter (full cut or partial cut) • Linerless with cutter • Linerless with tear 	
User Options	<ul style="list-style-type: none"> • 1.5" adaptor for 1.5" paper core • External roll mount, media O.D. 214 mm (8.4") with 25.4 mm (1") core • KP-200 Plus keyboard display unit (serial interface) 	

2 Operation Overview

2.1 Unpacking and Inspection

This printer has been specially packaged to withstand damage during shipping. Please carefully inspect the packaging and printer upon receiving the bar code printer. Please retain the packaging materials in case you need to reship the printer.

Unpacking the printer, the following items are included in the carton.

- One printer unit
- One quick installation guide
- One USB port cable
- One power cord
- One power adapter

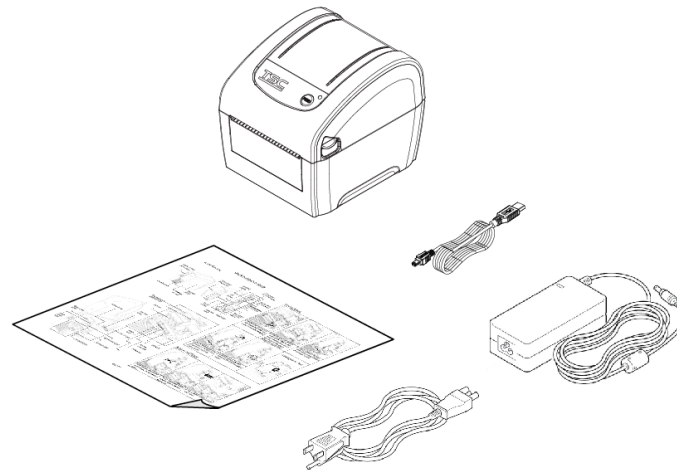

If any parts are missing, please contact the Customer Service Department of your purchased reseller or distributor.

3 Getting to Know Your Printer

3.1 Front View



1. Top cover open lever
2. LED indicators
3. Feed/Pause button

3.2 Interior View



1. Printhead
2. Gap sensor (transmitter)
3. Media viewer
4. Media holder
5. Platen roller
6. Media holder lock switch
7. Black mark sensor/ Gap sensor (receiver)

3.3 Rear View

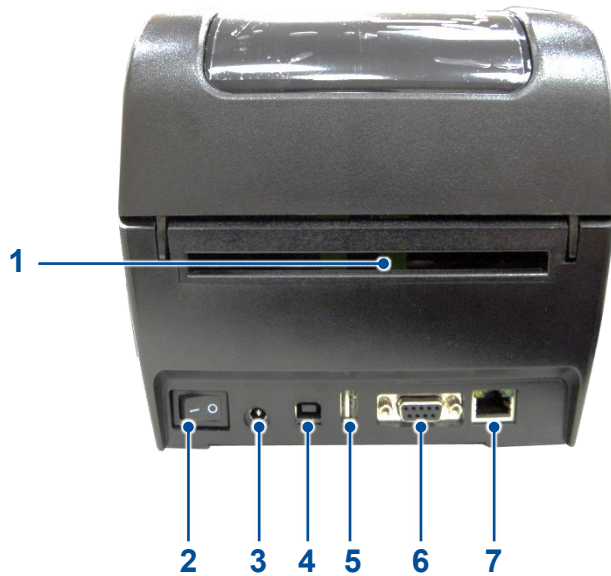

1. External label entrance chute
2. Power switch
3. Power jack socket
4. USB interface
5. USB host (For DA220 series)
6. RS-232 interface (For DA220 series)
7. Ethernet interface (For DA220 series)

NOTE: The interface picture here is for reference only. Please refer to the product specification for the interface availability.

4 Setup

4.1 Setting up the Printer

1. Place the printer on flat surface.
2. Make sure the printer is power off.
3. Connect the printer to the computer with the provided USB cable.
4. Plug in the power cord.

NOTE: Please switch OFF the printer before plugging in the power cord to printer power jack.

4.2 Loading the Media

	<p>1. Open the printer top cover by pulling the tabs.</p>		<p>2. Carefully pull to separate the media holders.</p>
	<p>3. Place the roll between the holders.</p>		<p>4. Place the paper, printing side face up, through the media sensor and place the label leading edge onto the platen roller.</p>
	<p>5. Gently close the top cover ensuring that the cover latches are firmly secured. Use hardware or software to make calibration (Refer to Chapter 4 and 5.).</p>		

4.3 Loading the External Media

	<p>1. Open the printer top cover by pulling the tabs.</p>		<p>2. Carefully pull to separate the media holders.</p>
	<p>3. Press down the media holder lock switch to secure the media holder in place.</p>		<p>4. Place the paper, printing side face up, through the media sensor and place the label leading edge onto the platen roller.</p>
	<p>5. Gently close the top cover ensuring that the cover latches are firmly secured. Use hardware or software to make calibration (Refer to Chapter 4 and 5.).</p>		

4.4 Loading Media in Peel-off Mode (Optional for DA220 series)

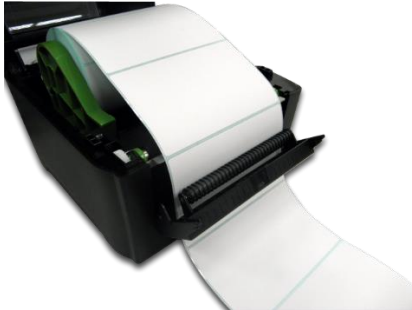
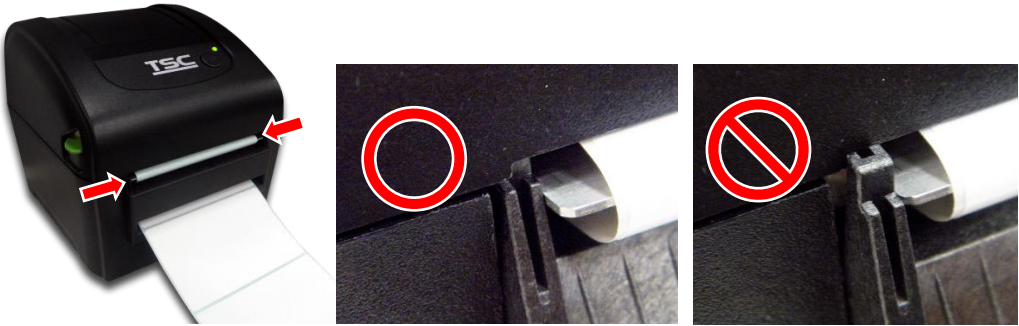
	<ol style="list-style-type: none">1. Please refer to section 3.2 to install the media. Place the label leading edge onto the platen roller.2. Close the top cover gently. Use software to make calibration and set the post-print action to "PEEL". You may refer to Chapter 5 for configuring the printer.
	<ol style="list-style-type: none">3. Move the media guides to fit the label width by pushing the media guide adjustment button.
	<ol style="list-style-type: none">4. Close the peel-off cover and printer cover. NOTE: Make sure the latches of peel-off cover are correctly secured by the printer cover.

4.5 Loading the Media in Cutter Mode (Optional for DA220 series)

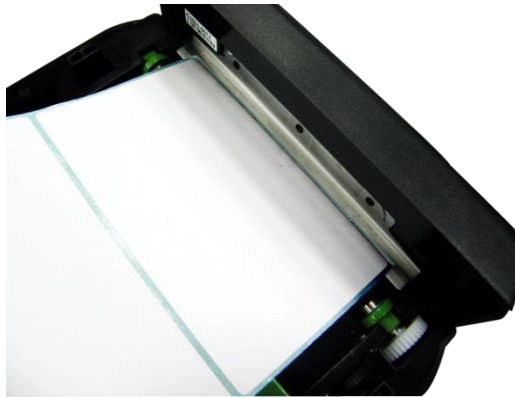

1. Please refer to section 3.2 to install the media. Thread the paper through the cutter paper opening.



2. Close the top cover gently. Use software to make calibration and set the post-print action to "CUTTER". You may refer to Chapter 5 for configuring the printer.

4.6 Loading Media in Linerless Tear Mode (Optional for DA220 series)

	<p>1. Open the printer cover.</p>		<p>2. Separate the media holders to the label width.</p>
	<p>3. Place the label leading edge onto the platen roller. (printing side face up)</p>		<p>4. Close the top cover gently. Use software to make calibration. You may refer to Chapter 4 and 5 for configuring the printer.</p>

4.7 Loading Media in Linerless Cutter Mode (Optional for DA220 series)

	<p>1. Open the printer cover.</p>		<p>2. Separate the media holders to the label width.</p>
	<p>3. Place the label leading edge onto the platen roller ensuring that the print side faces up.</p>		<p>4. Close the top cover gently. Use software to make calibration. You may refer to Chapter 4 and 5 for configuring the printer.</p>

4.8 Install the Adapter for 1.5" Paper Core (Optional)

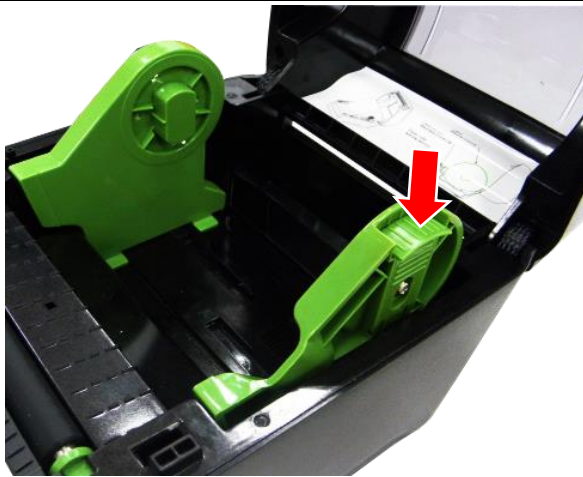

1. Please refer to section 3.2 to secure the media holders in place in order to install the 1.5" adapters.





2. Install the 1.5" adapters onto the left and right media holders in order to use the 1.5" core media roll.



5 LED and Button Functions

5.1 LED Indicator

Color	Description
 (Green)	Solid: Power is on and ready to be used. Flash: System is downloading data or printer is paused.
 (Amber)	System is clearing data.
 (Red)	Solid: Printer head open, cutter error. Flash: Printing error, such as paper empty, paper jam, ribbon empty, or memory error etc.

5.2 Regular Button Function

1. Feed labels

When the printer is ready, press the button to feed one label to the beginning of next label.

2. Pause the printing job

When the printer is printing, press the button to pause a printing job. When the printer is paused, the LED will be green blinking. Press the button again to continue the printing job.

5.3 Power-on Utilities

Power-on Utilities provides the basic functions and can be activated by below procedures:

Turn off the power > **Hold** the Feed button > **Open** the power > **Release** the Feed button depending on the color of the LED.

Sequences of the settings:

LED Colors Functions	Amber	Red (5 blinks)	Amber (5 blinks)	Green (5 blinks)	Green / Amber (5 blinks)	Red / Amber (5 blinks)	Solid green
1. Sensor Calibration (Gap / black mark sensor)		Release					
2. Self-Test (And enter dump mode)			Release				
3. Factory Default				Release			
4. Bline Calibration					Release		
5. Gap Calibration						Release	
6. READY (Skip AUTO.BAS)							Release

6 TSC Console

TSC Console is a management tool combining the Printer Management, Diagnostic Tool, CommTool and Printer Webpage settings, which enables you to adjust printer's settings/status; change printers' settings; download graphics, deploy fonts, graphics, label templates or upgrade the firmware to the group of printers, and send additional commands to printers at the same time.

※ **Printer firmware version before A2.12 will only use 9100 Port as command port; Printer firmware after A2.12 will use 6101 Port as command port.**

6.1 Starting TSC Console

1. Double click TSC Console icon to start the software.

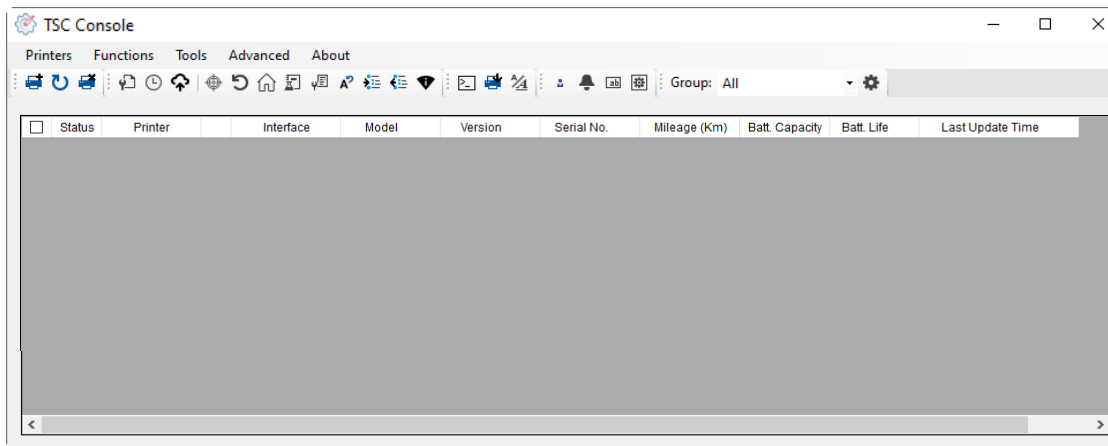

2. Manually add the devices by clicking **Printer > Add Printers**.

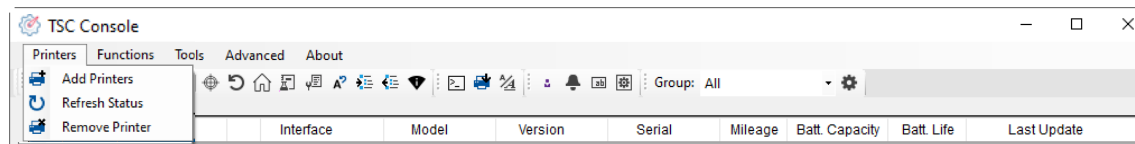

3. Select the current interface of the printer.

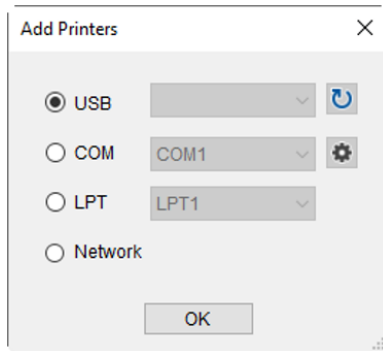

4. The printer will be added to **TSC Console's** interface.

5. Select the printer and set the settings.

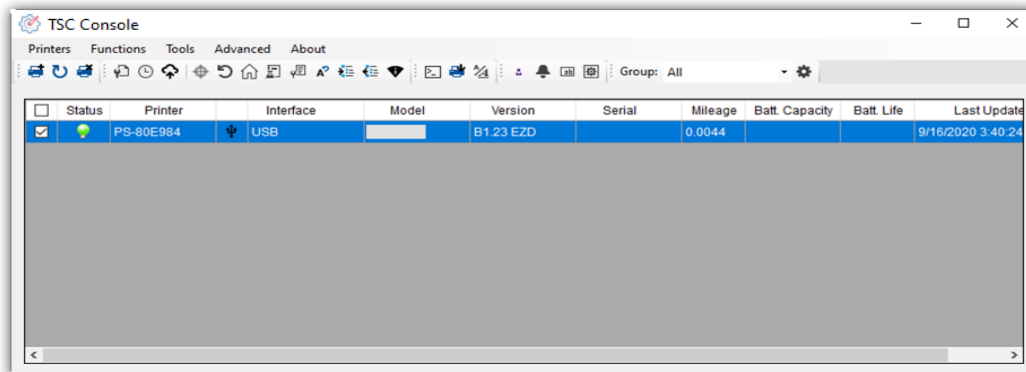

For more information, you may refer to **TSC Console User Manual**.

6.2 Setup Ethernet Interface

- Use **USB** or **COM** to establish the interface on **TSC Console**.

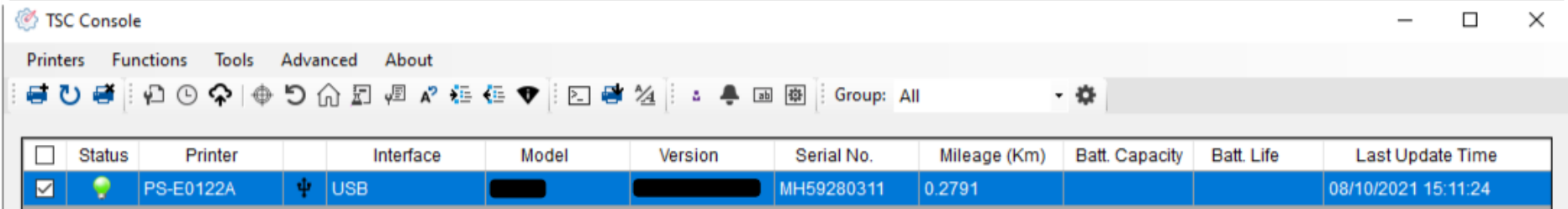

- Double click to enter the **Printer Configuration Page** > Click **Ethernet** tab > Check the **IP Address**.

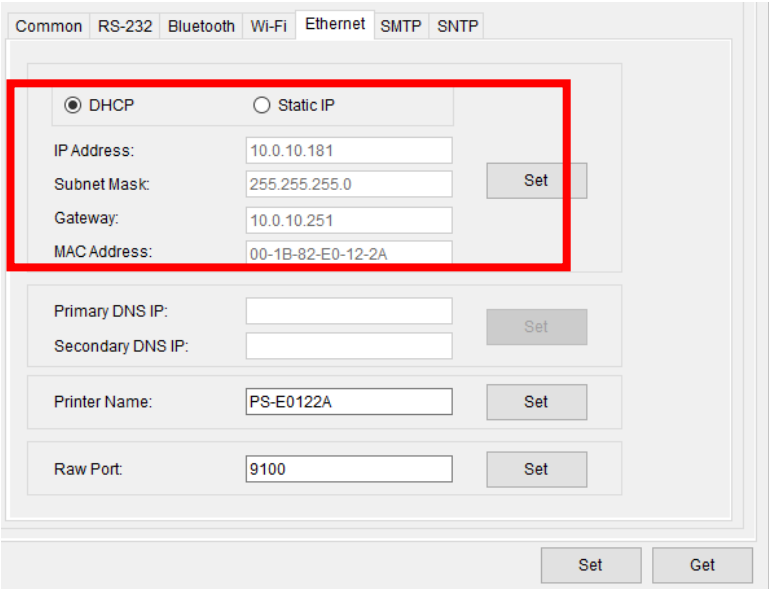
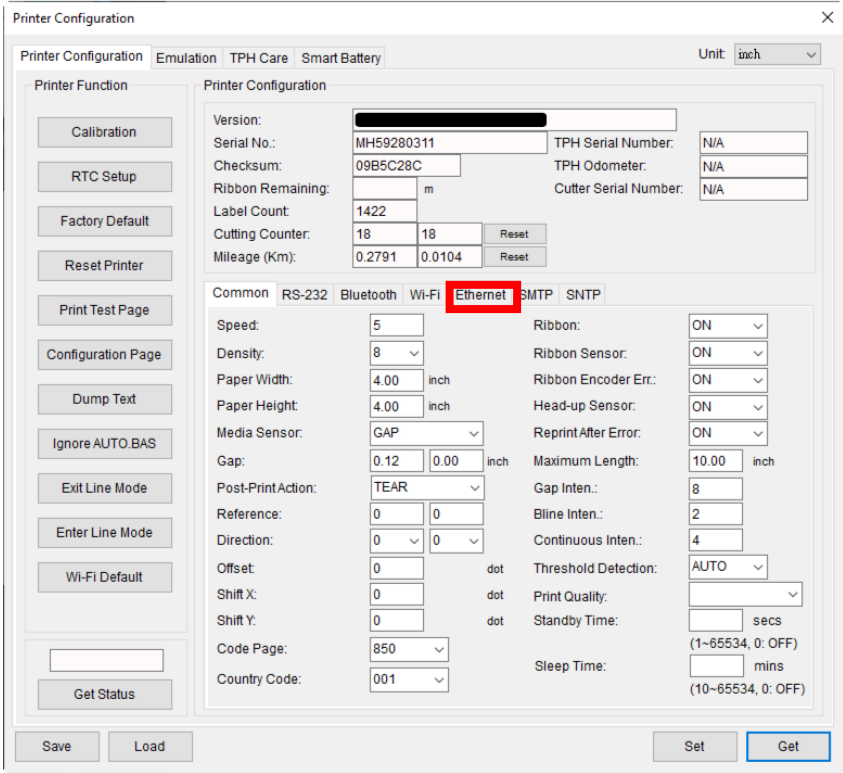

- Return to **TSC Console** main page > Click **Add Printer** on the top left of the window.

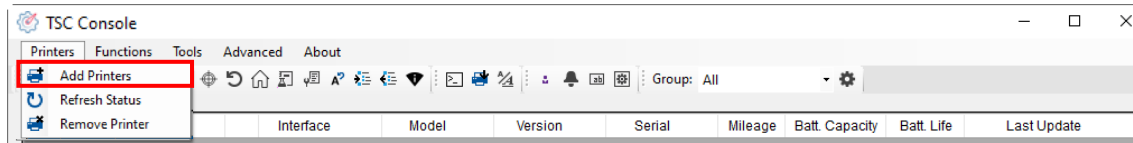

- Choose **Network** > Key in the **IP Address** > Click **Discover** to establish the Ethernet interface.

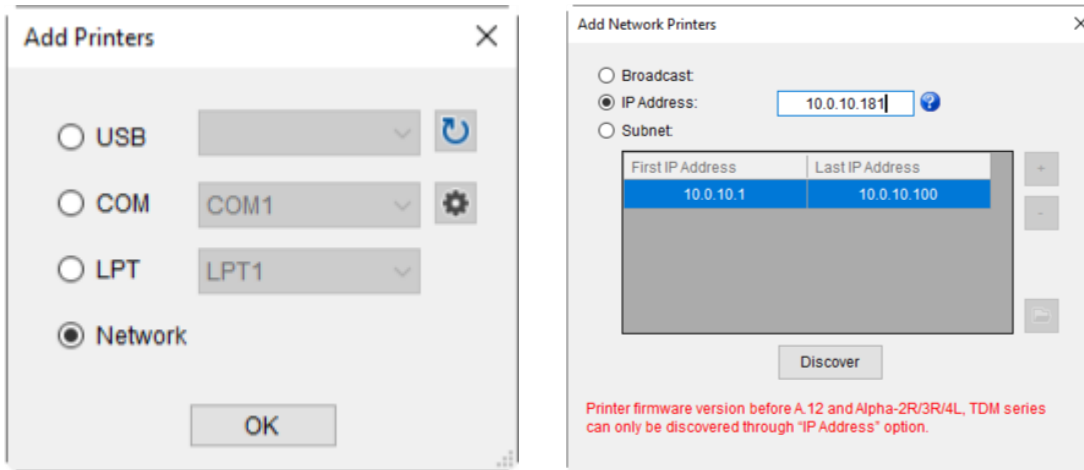

- The notification will pop up > Click **OK** to close the window > The Ethernet interface will be shown on **TSC Console**.

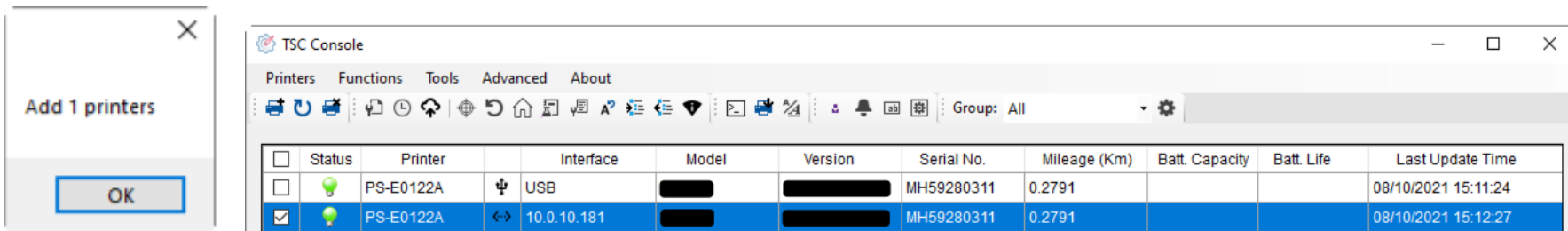

6.3 TPH Care

TPH Care provides users to check the condition of the printhead and be able to set the dot failure threshold for indicating errors when the threshold is triggered.

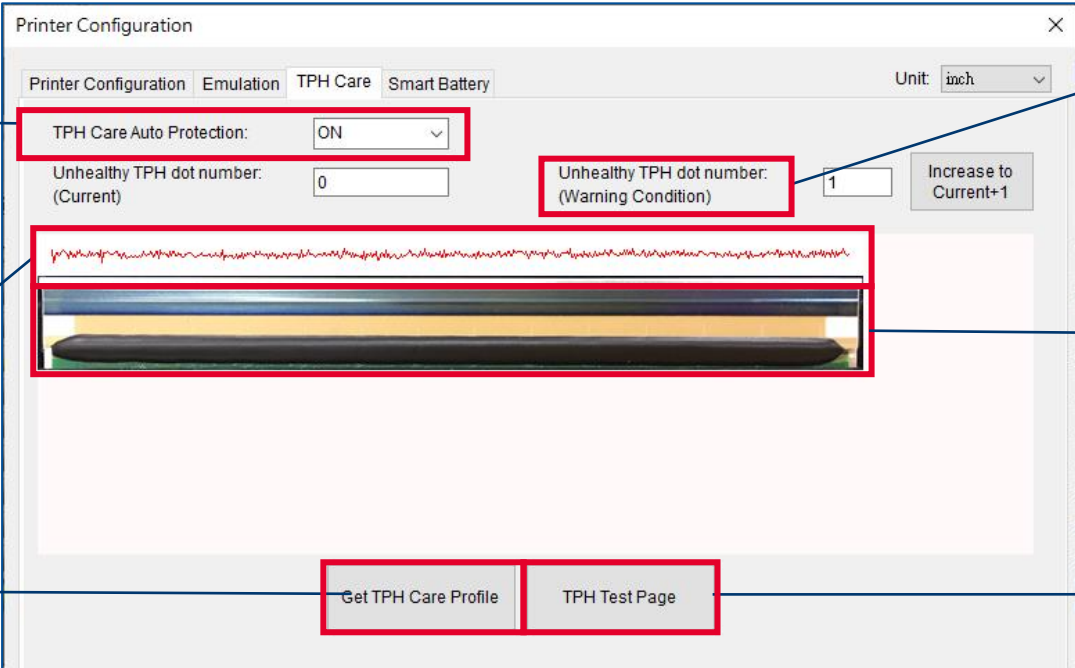

This option is used to enable (ON)/ disable (OFF) the TPH care function.

This option is used to check the numbers of unhealthy TPH dot element.

This option is used to detect the unhealthy TPH dot.

This option is used to set the threshold for unhealthy TPH dot number.

This image is used to check the relative position of the unhealthy TPH dot.

This option is used to print a TPH test image to check the TPH printing result.

1. Enable the TPH Care function. (Note: The default is disabled/OFF.) Then click "Get TPH care profile" button and a diagram will show in the area above.
2. If the profile is flat, it means that the printhead is good. Check "Unhealthy TPH dot number". If the result is zero (0), that means the printhead is good.
3. Bad dots are presented as a spike in the profile. The arrow in below profile indicates the presence of potentially damaged dots and printer will stop printing.



6.4 Printer Function

Printer Function could be found in Printer Configuration. “Printer Function” will be shown on the left side of the window.

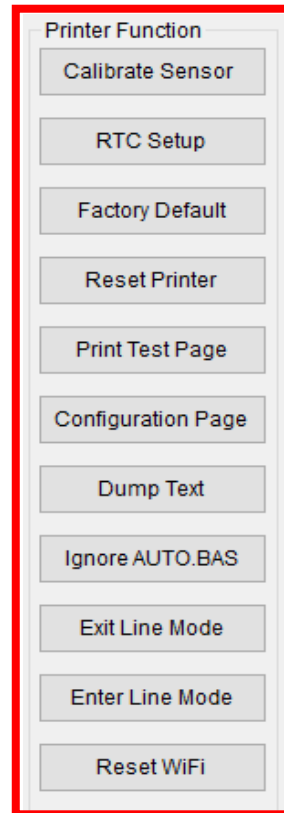

Functions	Description
Calibrate Sensor	Detect media types and the size of the label
RTC Setup	Synchronize printer with Real Time Clock on PC
Factory Default	Initialize the printer to default settings
Reset Printer	Reboot printer
Print Test Page	Print test page according to the specified label size and sensor type.
Configuration Page	Print printer configurations
Dump Text	Activate the printer to dump mode
Ignore AUTO.BAS	Ignore AUTO.BAS file when printer boot up.
Exit Line Mode	Exit the line mode to page mode
Enter Line Mode	Leave page mode and enter line mode
Reset Wi-Fi	Restore the Wi-Fi settings to defaults.

6.5 Setting Post-Print Action

When the printer is equipped with other option kits, ex: cutter, peeler, rewinder, please select the mode after finishing the calibration.

Follow below procedure to set the post action for the printing:

Refer Ch. 5.1 to Connect the printer with TSC Console > Double click the printer > The Printer Configuration Page will pop up > Click Get to load information > Go to Common Tab > Find Post-Print Action > Select the mode depending on users' application > Click Set.

The screenshot shows the 'Printer Configuration' window with the 'Common' tab selected. The 'Post-Print Action' dropdown menu is open, showing options: OFF, TEAR, PEEL, CUTTER, REWIND, and APPLICATOR. A red box labeled '2' highlights the dropdown menu. A red box labeled '1' highlights the 'Set' button at the bottom right. A red box labeled '3' highlights the 'Get' button at the bottom right. The 'Unit' is set to 'mm'.

Printer Function	Printer Configuration
Calibration	Version: []
RTC Setup	Serial No.: [] TPH Serial Number: N/A
Factory Default	Checksum: 1344B9B1 TPH Odometer: N/A
Reset Printer	Ribbon Remaining: [] % Cutter Serial Number: N/A
Print Test Page	Label Count: 553
Configuration Page	Cutting Counter: 0 0 Reset
Dump Text	Mileage (Km): 0.0913 0.0913 Reset
Ignore AUTO.BAS	Common RS-232 Bluetooth Wi-Fi Ethernet SMTP SNTP
Exit Line Mode	Speed: 3 Ribbon: OFF
Enter Line Mode	Density: 8 Ribbon Sensor: OFF
Wi-Fi Default	Paper Width: 104.00 mm Ribbon Encoder Err.: OFF
Get Status	Paper Height: 74.05 mm Head-up Sensor: ON
Save	Media Sensor: Black Mark Reprint After Error: ON
Load	Gap: 1.99 0.00 mm Maximum Length: 152.25 mm
	Post-Print Action: [] Gap Inten.: 7
	Reference: OFF Bline Inten.: 7
	Direction: TEAR Continuous Inten.: 4
	Offset: PEEL Threshold Detection: AUTO
	Shift X: CUTTER Print Quality: STANDARD
	Shift Y: REWIND Standby Time: 120 secs
	Code Page: 850 Sleep Time: 0 mins
	Country Code: 001 (1~65534, 0: OFF)
	(10~65534, 0: OFF)
	Set Get

7 Troubleshooting

This section lists the common problems that according to the LED status and other problems you may encounter when operating the printer. Also, it provides solutions.

LED Status

LED Status / Color	Printer Status	Possible Cause	Recovery Procedure
OFF	No response	No power	<ul style="list-style-type: none"> * Turn on the power switch. * Check if the green LED is lit on power supply. If it is not lit on, power supply is broken. * Check both power connections from the power cord to the power supply and from the power supply to the printer power jack if they are connected securely.
Solid Green	ON	The printer is ready to use	* No action necessary.
Green with blinking	Pause	The printer is paused	* Press the FEED button to resume for printing.
Red with blinking	Error	The out of label or the printer setting is not correct	<ol style="list-style-type: none"> 1. Out of label * Load a roll of label and follow the instructions in loading the media then press the FEED button to resume for printing. 2. Printer setting is not correct * Initialize the printer

Print Problem

Problem	Possible Cause	Recovery Procedure
Not Printing	Check if interface cable is well connected to the interface connector.	Re-connect cable to interface.
	The serial port cable pin configuration is not pin to pin connected.	Please replace the cable with pin to pin connected.
	The serial port setting is not consistent between host and printer.	Please reset the serial port setting.
	The port specified in the Windows driver is not correct.	Select the correct printer port in the driver.
	The Ethernet IP, subnet mask, gateway is not configured properly.	Configure the IP, subnet mask and gateway.
No print on the label	Label loaded not correctly.	Follow the instructions in loading the media.
Continuous feeding labels	The printer setting may go wrong.	Please do the initialization and gap/black mark calibration.
Paper Jam	Gap/black mark sensor sensitivity is not set properly (sensor sensitivity is not enough)	Calibrate the gap/black mark sensor.
	Make sure label size is set properly.	Set label size exactly as installed paper in the labeling software or program.
	Labels may be stuck inside the printer mechanism near the sensor area.	Remove the stuck label.
Poor Print Quality	Top cover is not closed properly.	Close the top cover completely and make sure the right side and left side levers are latched properly.
	Wrong power supply is connected with printer.	Check if 24V DC output is supplied by the power supply.
	Check if supply is loaded correctly.	Reload the supply.

Problem	Possible Cause	Recovery Procedure
	Check if dust or adhesives are accumulated on the printhead.	Clean the printhead.
	Check if print density is set properly.	Adjust the print density and print speed.
	Check printhead test pattern if head element is damaged.	Run printer self-test and check the printhead test pattern if there is dot missing in the pattern.

8 Maintenance

This session presents the clean tools and methods to maintain the printer.

■ For Cleaning

Depending on the media used, the printer may accumulate residues (media dust, adhesives, etc.) as a by-product of normal printing. To maintain the best printing quality, you should remove these residues by cleaning the printer periodically. Regularly clean the printhead and supply sensors once change a new media to keep the printer at the optimized performance and extend printer life.

■ For Disinfecting

Sanitize your printer to protect yourself and others and can help prevent the spread of viruses.

■ Important

- Set the printer power switch to O (Off) prior to performing any cleaning or disinfecting tasks. Leave the power cord connected to keep the printer grounded and to reduce the risk of electrostatic damage.
- Do not wear rings or other metallic objects while cleaning any interior area of the printer.
- Use only the cleaning agents recommended in this document. Use of other agents may damage the printer and void its warranty.
- Do not spray or drip liquid cleaning solutions directly into the printer. Apply the solution on a clean lint-free cloth and then apply the dampened cloth to the printer.
- Do not use canned air in the interior of the printer as it can blow dust and debris onto sensors and other critical components.
- Only use a vacuum cleaner with a nozzle and hose that are conductive and grounded to drain off static build up.
- All reference in these procedures for use of isopropyl alcohol requires that a 99% or greater isopropyl alcohol content be used to reduce the risk of moisture corrosion to the printhead.
- Do not touch printhead by hand. If you touch it carelessly, please use 99% Isopropyl alcohol to clean it.
- Always taking personal precaution when using any cleaning agent.

8.1 Cleaning Supplies

- Cotton swab
- Lint-free cloth
- Brush with soft non-metallic bristles
- Vacuum cleaner
- 75% Ethanol (for disinfecting)
- 99% Isopropyl alcohol (for printhead and platen roller cleaning)
- Genuine printhead cleaning pen
- Mild detergent (without chlorine)

8.2 Cleaning Procedures

Component	Method	Recommended Cleaning Schedule
Printhead	<ol style="list-style-type: none"> 1. Power off the printer before cleaning the printhead. 2. Leave the printhead to cool down for at least one minute. 3. Wet a cotton swab with the 99% Isopropyl alcohol and then wipe across the printhead head. You can also use the genuine printhead cleaning pen to clean the printhead. 	Clean the printhead when you load new media.
Platen Roller	<ol style="list-style-type: none"> 1. Power off the printer. 2. Use a piece of 99% Isopropyl alcohol saturated lint-free cloth to wipe the platen roller while rotating the platen roller. 	Clean the platen roller when you load new media.
Peel Bar	Use a piece of 99% Isopropyl alcohol saturated lint-free cloth to wipe the peel bar.	Clean as needed.
Sensor	Use the brush with soft and non-metallic bristles or vacuum cleaner to remove the dust or particles in order to optimize the print quality or sensor calibration.	Clean the sensor monthly.
Exterior	Use a piece of water-dampened lint-free cloth to wipe the surface. If necessary, you can apply the chlorine free detergent. After finishing cleaning, use the 75% ethanol to disinfect the surface.	Clean as needed.
Interior	Use the brush with soft and non-metallic bristles or vacuum cleaner to remove the dust or particles. After finishing cleaning, use the 75% ethanol to disinfect the interior.	Clean as needed.
Linerless Printer	<p>Please refer to Linerless Cleaning Kit User Manual for more information.</p> 	<ul style="list-style-type: none"> • Clean as needed or after printing every 1 km. • Please determine the maintenance intervals based on actual usage.

9 Agency Compliance and Approvals



EN 55032, Class A
EN 55024
EN 60950-1; EN 61000-3-2; EN 61000-3-3

This is a class A product. In a domestic environment this product may cause radio interference in which case the user may be required to take adequate measures.

FCC part 15B, Class A
ICES-003, Class A

This equipment has been tested and found to comply with the limits for a Class A digital device, pursuant to Part 15 of the FCC Rules. These limits are designed to provide reasonable protection against harmful interference when the equipment is operated in a commercial environment.

This equipment generates, uses, and can radiate radio frequency energy and, if not installed and used in accordance with the manufacturer's instruction manual, may cause harmful interference with radio communications. Operation of this equipment in a residential area is likely to cause harmful interference, in which case you will be required to correct the interference at your own expense.

This Class A digital apparatus complies with Canadian ICES-003.
Cet appareil numérique de la classe A est conform à la norme NMB-003 du Canada.

This device complies with Part 15 of the FCC Rules. Operation is subject to the following two conditions: (1) This device may cause harmful interference, and (2) this device must accept any interference received, including interference that may cause undesired operation.



AS/NZS CISPR 32, Class A



KN 32
KN 35

이 기기는 업무용(A 급) 전자파적합기기로서 판매자 또는 사용자는 이 점을 주의하시기 바라며, 가정외의 지역에서 사용하는 것을 목적으로 합니다.



GB 4943.1
GB 9254, Class A
GB 17625.1

此为 A 级产品，在生活环境中，该产品可能会造成无线电干扰，在这种情况下，可能需要用户对干扰采取切实可行的措施。



IS 13252(Part 1)/
IEC 60950-1



UL 60950-1(2nd Edition)
CSA C22.2 No. 60950-1-07(2nd Edition)



Energy Star for Imaging Equipment Version 3.2



TP TC 004/2011
TP TC 020/2011



LP0002

Note: There may have certification differences in the series models, please refer to product label for accuracy.

Important safety instructions:

1. Read all of these instructions and keep them for later use.
2. Follow all warnings and instructions on the product.
3. Disconnect the power plug from the AC outlet before cleaning or if fault happened.
Do not use liquid or aerosol cleaners. Using a damp cloth is suitable for cleaning.
4. The mains socket shall be installed near the equipment and easily accessible.
5. The unit must be protected against moisture.
6. Ensure the stability when installing the device, Tipping or dropping could cause damage.
7. Make sure to follow the correct power rating and power type indicated on marking label provided by manufacture.
8. Please refer to user manual for maximum operation ambient temperature.

WARNING:

Hazardous moving parts, keep fingers and other body parts away.

CAUTION:

(For equipment with RTC (CR2032) battery or rechargeable battery pack)

Risk of explosion if battery is replaced by an incorrect type.

Dispose of used batteries according to the Instructions as below.

1. DO NOT throw the battery in fire.
2. DO NOT short circuit the contacts.
3. DO NOT disassemble the battery.
4. DO NOT throw the battery in municipal waste.
5. The symbol of the crossed out wheeled bin indicates that the battery should not be placed in municipal waste.



Caution: The printhead may be hot and could cause severe burns. Allow the printhead to cool.

CAUTION:

Any changes or modifications not expressly approved by the grantee of this device could void the user's authority to operate the equipment.

Below statement are for product with optional RF function.

CE Statement:

This equipment complies with EU radiation exposure limits set forth for an uncontrolled environment. This equipment should be installed and operated with minimum distance 20 cm between the radiator & your body.

All operational modes:

2.4GHz: 802.11b, 802.11g, 802.11n (HT20), 802.11n (HT40)

5GHz: 802.11a,

The frequency, mode and the maximum transmitted power in EU are listed below:

2400 MHz – 2483.5 MHz: 19.88 dBm (EIRP)(Wi-Fi)

5150 MHz – 5250 MHz: 17.51 dBm (EIRP)(Wi-Fi)

2402 MHz – 2480 MHz: 6.02 dBm (EIRP)(Bluetooth)

Requirements in

AT/BE/BG/CZ/DK/EE/FR/DE/IS/IE/IT/EL/ES/CY/LV/LI/LT/LU/HU/MT/NL/NO/PL/PT/RO/SI/SK/TR/FI/SE/CH/UK/HR.

5150MHz~5350MHz is for indoor use only.

5150-5350MHz for Only indoor use

5470-5725MHz for indoor/outdoor use



Restrictions In AZE

National restrictions information is provided below

Frequency Band	Country	Remark
5150-5350MHz	Azerbaijan	No license needed if used indoor and power not exceeding 30mW
5470-5725MHz		

Hereby, TSC Auto ID Technology Co., Ltd. declares that the radio equipment type [Wi-Fi] IEEE 802.11 a/b/g/n is in compliance with Directive 2014/53/EU

The full text of the EU declaration of conformity is available on TSC website <https://www.tscprinters.com>

FCC Statement:

RF exposure warning (For Wi-Fi)

This equipment must be installed and operated in accordance with provided instructions and must not be co-located or operating in conjunction with any other antenna or transmitter. End-users and installers must be providing with antenna installation instructions and transmitter operating conditions for satisfying RF exposure compliance.

RF exposure warning (For Bluetooth)

The equipment complies with FCC RF exposure limits set forth for an uncontrolled environment.

The equipment must not be co-located or operating in conjunction with any other antenna or transmitter.

Canada, Industry Canada (IC) Notices

This Class B digital apparatus complies with Canadian ICES-003 and RSS-210.

Operation is subject to the following two conditions: (1) this device may not cause interference, and (2) this device must accept any interference, including interference that may cause undesired operation of the device.

Radio Frequency (RF) Exposure Information

The radiated output power of the Wireless Device is below the Industry Canada (IC) radio frequency exposure limits. The Wireless Device should be used in such a manner such that the potential for human contact during normal operation is minimized.

This device has also been evaluated and shown compliant with the IC RF Exposure limits under portable exposure conditions. (Antennas are less than 20 cm of a person's body). **(For Bluetooth)**

Canada, avis de l'Industry Canada (IC)

Cet appareil numérique de classe B est conforme aux normes canadiennes ICES-003 et RSS-210.

Son fonctionnement est soumis aux deux conditions suivantes : (1) cet appareil ne doit pas causer d'interférence et (2) cet appareil doit accepter toute interférence, notamment les interférences qui peuvent affecter son fonctionnement.

Informations concernant l'exposition aux fréquences radio (RF)

La puissance de sortie émise par l'appareil sans fil est inférieure à la limite d'exposition aux fréquences radio de l'Industry Canada (IC). Utilisez l'appareil sans fil de façon à minimiser les contacts humains lors du fonctionnement normal.

Ce périphérique a également été évalué et démontré conforme aux limites d'exposition radio-fréquence par l'IC pour des utilisations par des opérateurs mobiles (les antennes sont à moins de 20 cm du corps d'une personne). **(Pour le Bluetooth)**

NCC 警語:

經型式認證合格之低功率射頻電機，非經許可，公司、商號或使用者均不得擅自變更頻率、加大功率或變更原設計之特性及功能。(即低功率電波輻射性電機管理辦法第十二條)

低功率射頻電機之使用不得影響飛航安全及干擾合法通信；經發現有干擾現象時，應立即停用，並改善至無干擾時方得繼續使用。前項合法通信，指依電信法規定作業之無線電通信。低功率射頻電機須忍受合法通信或工業、科學及醫療用電波輻射性電機設備之干擾。(即低功率電波輻射性電機管理辦法第十四條)

BSMI Class A 警語:

這是甲類的資訊產品，在居住的環境使用中時，可能會造成射頻 干擾，在這種情況下，使用者會被要求採取某些適當的對策。

MFi for Bluetooth

Use of the Made for Apple badge means that an accessory has been designed to connect specifically to the Apple product(s) identified in the badge, and has been certified by the developer to meet Apple performance standards. Apple is not responsible for the operation of this device or its compliance with safety and regulatory standards.

For US Model

Made for iPhone®XS Max, iPhone XS, iPhone XR, iPhone X, iPhone 8, iPhone 8 Plus, iPhone 7, iPhone 7 Plus, iPhone SE, iPhone 6s, iPhone 6s Plus, iPhone 6, iPhone 6 Plus, iPhone 5s, iPad Pro® 12.9-inch (2nd generation), iPad Pro 10.5-inch, iPad® (6th generation), iPad (5th generation), iPad Pro 9.7-inch, iPad Pro 12.9-inch (1st generation), iPad Air® 2, iPad mini™ 4, iPad mini 3, iPad Air, iPad mini 2, iPod touch® (6th generation)

iPad, iPad Air, iPad Pro, iPhone are trademarks of Apple Inc., registered in the U.S. and other countries.

For JP Model

Made for iPhone XS Max, iPhone XS, iPhone XR, iPhone X, iPhone 8, iPhone 8 Plus, iPhone 7, iPhone 7 Plus, iPhone SE, iPhone 6s, iPhone 6s Plus, iPhone 6, iPhone 6 Plus, iPhone 5s, iPad Pro 12.9-inch (2nd generation), iPad Pro 10.5-inch, iPad (6th generation), iPad (5th generation), iPad Pro 9.7-inch, iPad Pro 12.9-inch (1st generation), iPad Air 2, iPad mini 4, iPad mini 3, iPad Air, iPad mini 2, iPod touch (6th generation)

iPad, iPad Air, iPad Pro, iPhone are trademarks of Apple Inc., registered in the U.S. and other countries. The trademark “iPhone” is used in Japan with a license from Aiphone K.K.

Except for US, JP Model

Made for iPhone XS Max, iPhone XS, iPhone XR, iPhone X, iPhone 8, iPhone 8 Plus, iPhone 7, iPhone 7 Plus, iPhone SE, iPhone 6s, iPhone 6s Plus, iPhone 6, iPhone 6 Plus, iPhone 5s, iPad Pro 12.9-inch (2nd generation), iPad Pro 10.5-inch, iPad (6th generation), iPad (5th generation), iPad Pro 9.7-inch, iPad Pro 12.9-inch (1st generation), iPad Air 2, iPad mini 4, iPad mini 3, iPad Air, iPad mini 2, iPod touch (6th generation)

iPad, iPad Air, iPad Pro, iPhone are trademarks of Apple Inc., registered in the U.S. and other countries.

Revision History

Date	Content	Editor
2022/10/31	Add linerless info. (dealer option)	Camille
2023/08/11	Modify the Unpacking and Inspection section	Camille
2024/01/09	Added the specification tables, from page 6 to 11.	Peter Yao
2024/01/10	Updated the Energy Star for Imaging Equipment Version from 2.0 to 3.2, page 39.	Peter Yao
2024/03/21	Added information about how to clean a linerless printer, page 38.	Peter Yao



www.tscprinters.com