

TTP-384M

**THERMAL TRANSFER / DIRECT THERMAL
BAR CODE PRINTER**

**USER'S
MANUAL**

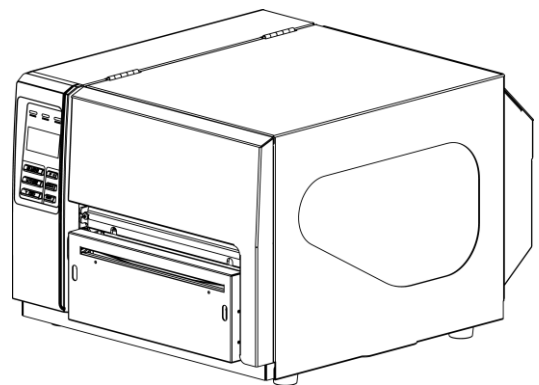

Contents

1. Introduction	1
1.1 Product Introduction	1
1.2 Compliances	1
2. Operations Overview	4
2.1 Unpacking and Inspection	4
2.2 Printer Overview	5
2.2.1 Front View	5
2.2.2 Interior view	6
2.2.3 Rear View	7
2.3 Operator Controls	9
2.3.1 Front Panel Display	9
2.3.2 LED Indicators	9
2.3.3 Front Panel Keys	10
2.4 Setting Up the Printer	10
2.5 Loading Ribbon	11
2.6 Loading Media	14
3. Menu Function	18
3.1 Setup Menu Overview	19
3.1.1 Printer Setup	20
3.1.2 Sensor	27
3.1.3 Serial Comm.	35
3.1.4 Ethernet	39
3.2 File Manager	42
3.2.1 File List	42
3.2.2 Avail. Memory	42
3.2.3 Del. All Files	43
3.3 Diagnostics	44
3.3.1 Print Config.	44
3.3.2 Dump Mode	47
3.3.3 Rotate Cutter	48
3.4 Language	48
3.5 Service	49
3.5.1 Initialization	49
3.5.2 Mileage Info.	50
4. Diagnostic Tool	51

4.1 Start the Diagnostic Tool	51
4.2 Printer Function (Calibrate sensor, Ethernet setup, RTC setup.....)	52
5 Setting Ethernet by Diagnostic Utility	53
5.1 Using USB interface to setup Ethernet interface	53
5.2 Using RS-232 interface to setup Ethernet interface	54
5.3 Using Ethernet interface to setup Ethernet interface	55
6. Troubleshooting	57
6.1 Common Problems.....	57
6.2 Mechanism Fine Adjustment to Avoid Ribbon Wrinkles	61
7. Maintenance	63
Revise History	65

1. Introduction

1.1 Product Introduction

Thank you very much for purchasing TSC bar code printer.

This printer is designed with die-casting aluminum chassis and print mechanism, metal cover with large clear media view window, which ensuring to work for the extreme and heavy duty industrial environment and applications.

With back-lit graphic LCD display, printer status can be managed easier and operated more user friendly. The moveable sensor design can accept wide range of label media. All of the most frequently used bar code formats are included. Fonts and bar codes can be printed in any one of the four directions. This printer is built-in the high quality, high performance MONOTYPE IMAGING® True Type font engine and one CG Triumvirate Bold Condensed smooth font. With flexible firmware design, user can also download the True Type Font from PC into printer memory for printing labels. Besides the scalable font, it also provides a choice of five different sizes of alphanumeric bitmap font, OCR-A and OCR-B fonts. By integrating rich features, it is the most cost-effective and high performance printer in its class!

Specifications, accessories, parts and programs are subject to change without notice.

1.2 Compliances

CE Class A:

EN55022:1998+A1:2000+A2:2003:

EN55024:1998+A1:2001+A2:2003:

EN 61000-4 SERIES REGULATIONS

ETSI EN 301 489-17:V1.2.1(2002-08)

FCC:

CFR 47, Part 15/CISPR 22 3RD EDITION:1997, Class A

<p>This device complies with Part 15 of the FCC Rules. Operation is subject to the following two conditions. (1) This device may not cause harmful interference, and (2) This device must accept any interference received, including interference that may cause undesired operation.</p>
--

CCC

UL, CUL

UL 60950-1 1st

TÜV/Safety:

IEC60950-1: 2001
EN 60950-1/A11:2004

Wichtige Sicherheits-Hinweise

1. Bitte lesen Sie diese Hinweis sorgfältig durch.
2. Heben Sie diese Anleitung für den späteren Gebrauch auf.
3. Vor jedem Reinigen ist das Gerät vom Stromnetz zu trennen. Verwenden Sie keine Flüssig-oder Aerosolreiniger. Am besten eignet sich ein angefeuchtetes Tuch zur Reinigung.
4. Die Netzanschluß-Steckdose soll nahe dem Gerät angebracht und leicht zugänglich sein.
5. Das Gerät ist vor Feuchtigkeit zu schützen.
6. Bei der Aufstellung des Gerätes ist auf sicheren Stand zu achten. Ein Kippen oder Fallen könnte Beschädigungen hervorrufen.
7. Beachten Sie beim Anschluß ans Stromnetz die Anschlußwerte.
8. Dieses Gerät kann bis zu einer Außentemperatur von maximal 40°C betrieben werden.

CAUTION

1. **HAZARDOUS MOVING PARTS IN CUTTER MODULE. KEEP FINGER AND OTHER BODY PARTS AWAY.**
2. **THE MAIN BOARD INCLUDES REAL TIME CLOCK FEATURE HAS LITHIUM BATTERY CR2032 INSTALLED. RISK OF EXPLOSION IF BATTERY IS REPLACED BY AN INCORRECT TYPE.**
3. **DISPOSE OF USED BATTERIES ACCORDING TO THE MANUFACTURER INSTRUCTIONS.**

ATTENTION

1. **PIECES DANGEREUSES EN MOUVEMENT DANS LE MODULE DE COUPAGE. GARDER VOS DOIGTS ET AUTRES PARTIES DU CORPS À L'ÉCART DE CES ZONES.**
2. **LE CIRCUIT PRINCIPAL CONTIENT UNE HORLOGE EN TEMPS RÉEL AVEC UNE BATTERIE AU LITHIUM DE TYPE CR2032. RISQUE D'EXPLOSION SI LA PILE EST REMPLACÉE PAR UNE PILE D'UN AUTRE TYPE.**
3. **SUIVRE LES INSTRUCTIONS DU FABRICANT POUR LA MISE AU REBUT DES PILES USÉES.**

"ORSICHT"

Explosionsgefahr bei unsachgemem Austausch der Batterie. Ersatz nur durch denselben oder einem vom Hersteller empfohlenem nlichen Typ. Entsorgung gebrauchter Batterien nach Angaben des Herstellers.

在产品的使用手册上有以下声明：此为 A 级产品，在生活环境中，该产品可能会造成无线电干扰。在这种情况下，可能需要用户对干扰采取切实可行的措施。

A 급기기

(업무용 정보통신기기)

이 기기는 업무용으로 전자파 적합등록을 한 기기이오니, 판매자 또는 사용자는 이 점을 주위하시기

바라며, 만약 잘못 판매 또는 구입하였을 때에는 가정용으로 교환하시기 바랍니다.

2. Operations Overview

2.1 Unpacking and Inspection

This printer has been specially packaged to withstand damage during shipping. Please carefully inspect the packaging and printer upon receiving the bar code printer. Please retain the packaging materials in case you need to reship the printer.

Unpacking the printer, the following items are included in the carton.

- One printer unit
- One Windows labeling software/Windows driver CD disk
- One quick installation guide
- One power cord
- One USB interface cable
- One ribbon take up paper core

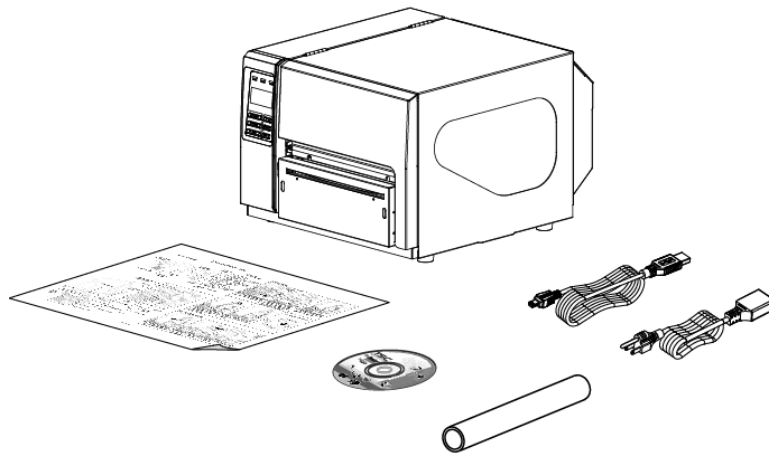

If any parts are missing, please contact the Customer Service Department of your purchased reseller or distributor.

2.2 Printer Overview

2.2.1 Front View



1. LED indicators
2. LCD display
3. Front panel buttons
4. Paper exit chute
5. Printer cover
6. Cutter module (Optional)

2.2.2 Interior view

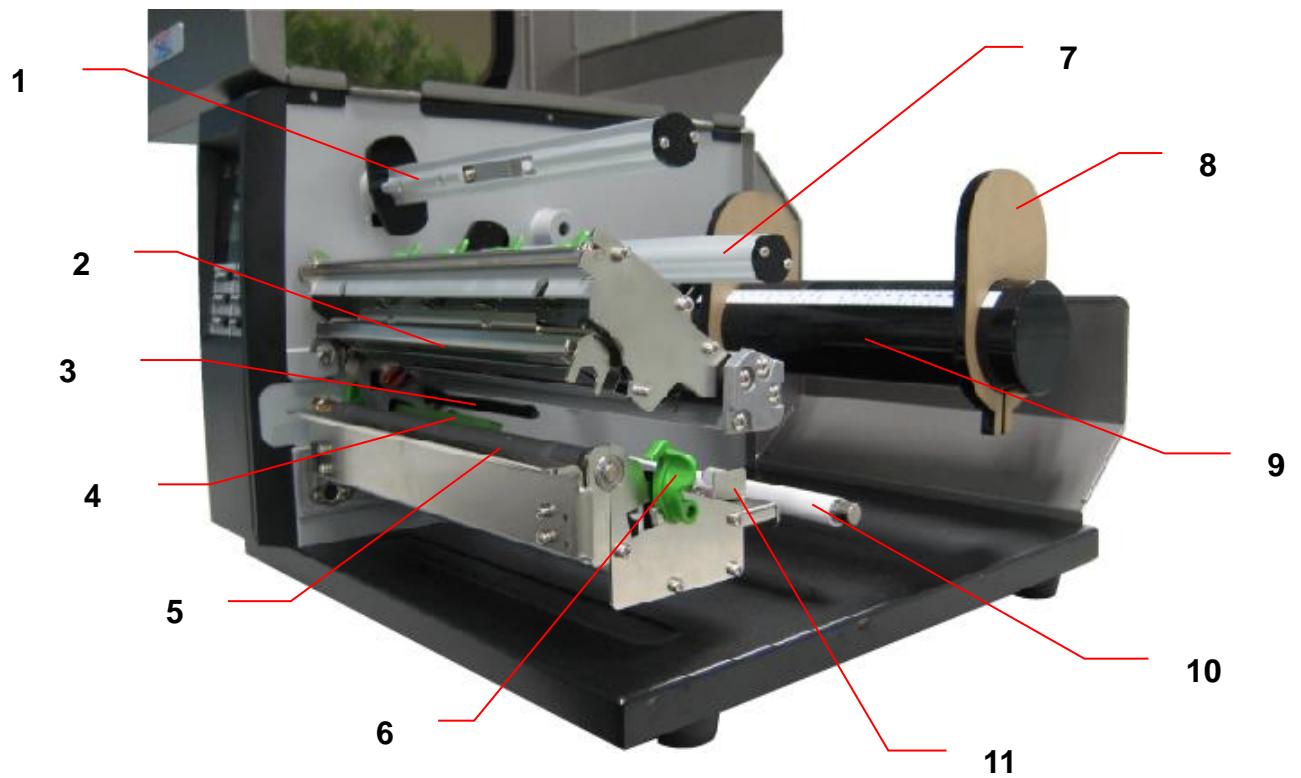

1. Ribbon rewind spindle
2. Print head
3. Ribbon sensor
4. Media sensor
5. Platen roller
6. Print head release lever
7. Ribbon supply spindle
8. Label roll guard
9. Label supply spindle
10. Media guide bar
11. Label guide

2.2.3 Rear View

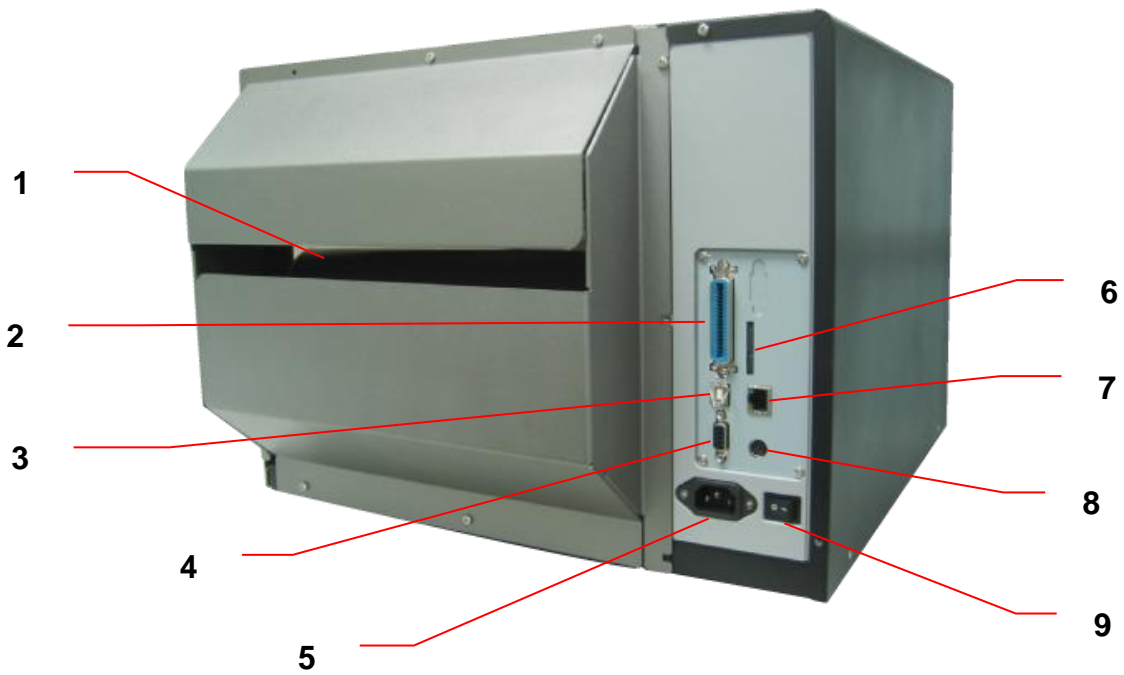

1. Fan-fold paper entrance chute
2. Centronics interface
3. USB interface
4. RS-232C interface
5. Power jack socket
- *6. SD card slot
7. Ethernet interface
8. PS/2 interface
9. Power switch

* Recommended SD card specification.

SD card spec	SD card capacity	Approved SD card manufacturer
V1.0, V1.1	128 MB	SanDisk, Transcend
V1.0, V1.1	256 MB	SanDisk, Transcend, Panasonic
V1.0, V1.1	512 MB	SanDisk, Transcend, Panasonic
V1.0, V1.1	1 GB	SanDisk, Transcend, Panasonic
V2.0 SDHC CLASS 4	4 GB	
V2.0 SDHC CLASS 6	4 GB	SanDisk, Transcend, Panasonic
V1.0, V1.1	microSD 128 MB	Transcend, Panasonic

V1.0, V1.1	microSD 256 MB	Transcend, Panasonic
V1.0, V1.1	microSD 512 MB	Panasonic
V1.0, V1.1	microSD 1 GB	Transcend, Panasonic
V2.0 SDHC CLASS 4	microSD 4 GB	Panasonic
V2.0 SDHC CLASS 6	microSD 4 GB	Transcend
V1.0, V1.1	miniSD 128 MB	Transcend, Panasonic
V1.0, V1.1	miniSD 256 MB	Transcend, Panasonic
V1.0, V1.1	miniSD 512 MB	Transcend, Panasonic
V1.0, V1.1	miniSD 1 GB	Transcend, Panasonic
V2.0 SDHC CLASS 4	miniSD 4 GB	Transcend
V2.0 SDHC CLASS 6	miniSD 4 GB	
<ul style="list-style-type: none"> - The DOS FAT file system is supported for the SD card. - Folders/files stored in the SD card should be in the 8.3 filename format - The miniSD/microSD card to SD card slot adapter is required. 		

Note:

The interface picture here is for reference only. Please refer to the product specification for the interfaces availability.

2.3 Operator Controls



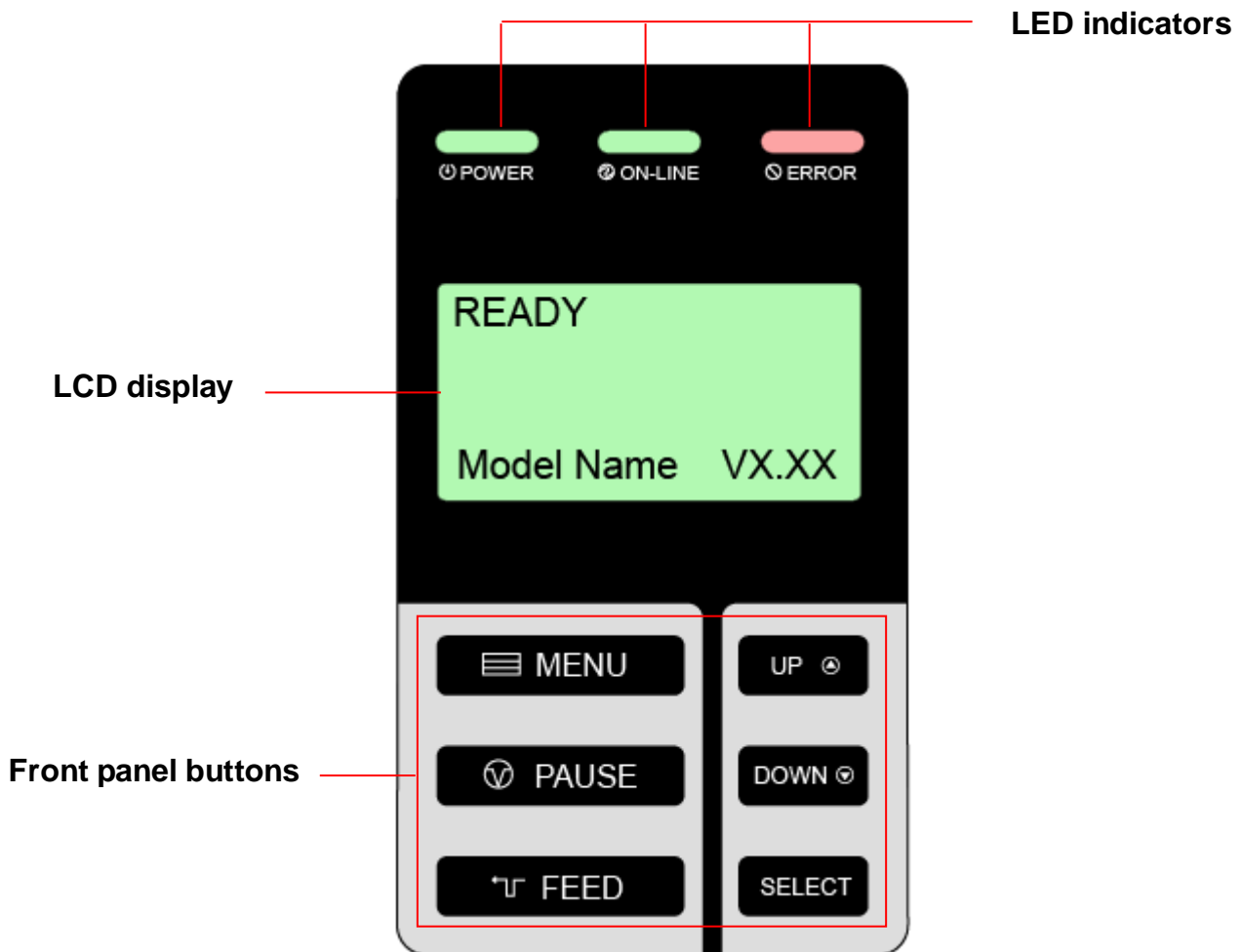

2.3.1 Front Panel Display



2.3.2 LED Indicators

LED	Status	Indication
⏻ POWER	Off	Printer power off
	On	Printer power on
📶 ON-LINE	On	Printer is ready
	Blinking	Printer is paused Printer is downloading data
🚫 ERROR	Off	Printer is ready
	On	Carriage open OR Cutter error
	Blinking	No paper, Paper jam OR "No ribbon

2.3.3 Front Panel Keys

Keys	Function
 MENU	1. Enter the menu system 2. Once in the menu system, return to previous menu. If at menu root, exits the menu system.
 PAUSE	Pauses or resumes printing
 FEED	Advance one label
UP 	Scroll up the menu options
DOWN 	Scroll down the menu options
SELECT	Select the currently highlighted option

2.4 Setting Up the Printer

1. Place the printer on a flat, secure surface.
2. Make sure the power switch is off.
3. Connect the printer to the computer with the provided USB cable.
4. Plug the power cord into the AC power cord socket at the rear of the printer, and then plug the power cord into a properly grounded power outlet.

Note:

Please switch OFF printer power switch prior to plug in the power cord to printer power jack.

2.5 Loading Ribbon

1. Lift printer cover open.
2. Push the print head release lever to open the print head mechanism.

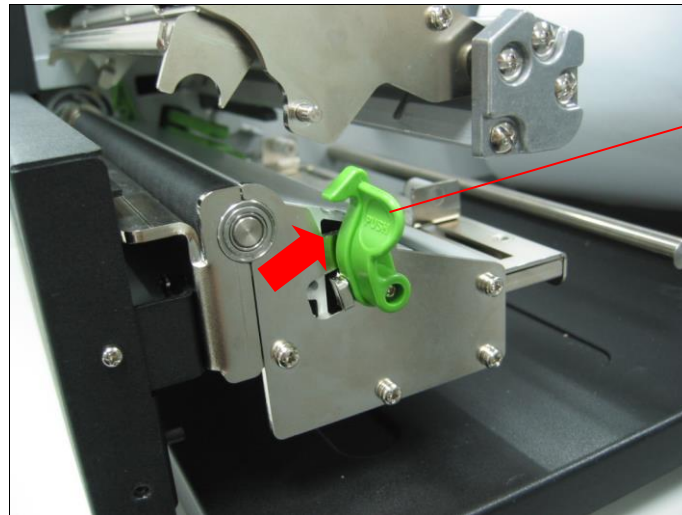

Print head
release lever

3. Install the ribbon onto the ribbon supply spindle.
Note: Make sure the ribbon is set at the center of the spindle.

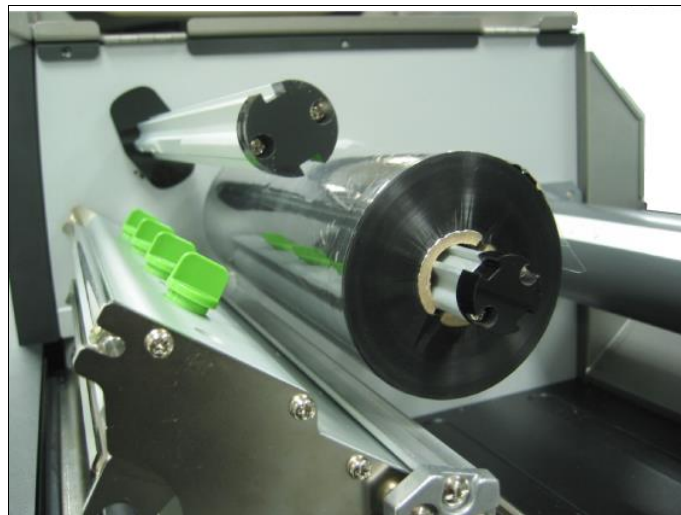

4. Install the paper core onto the ribbon rewind spindle.
Note: Make sure the paper core is set at the center of the spindle.

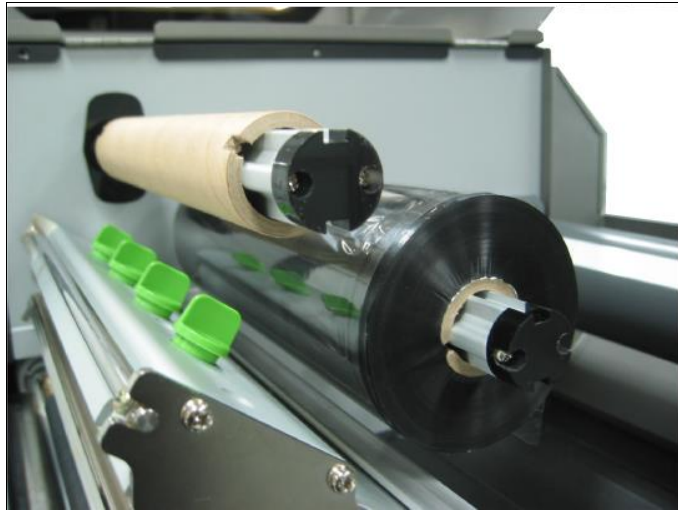

5. Thread the ribbon through the ribbon sensor slot and print head.

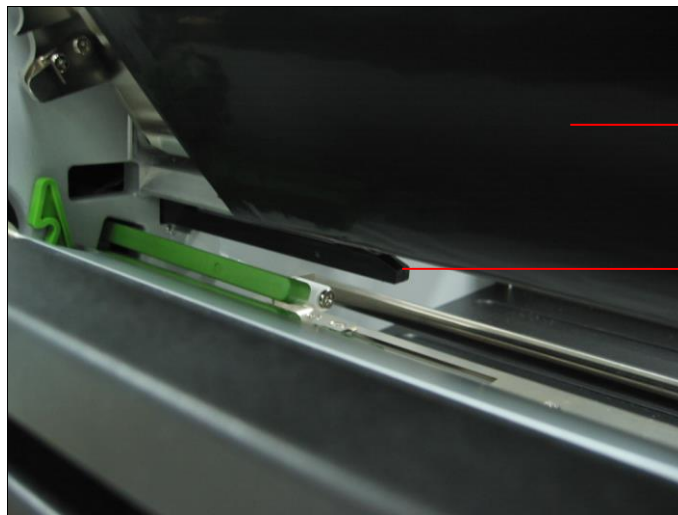

Ribbon

**Ribbon
sensor**

5. Stick ribbon onto ribbon rewind paper core, keeping the ribbon flat and wrinkle-free.
6. Wind the ribbon rewind spindle clockwise roughly 3~5 circles until ribbon is smooth, properly stretched and wrinkle-free.

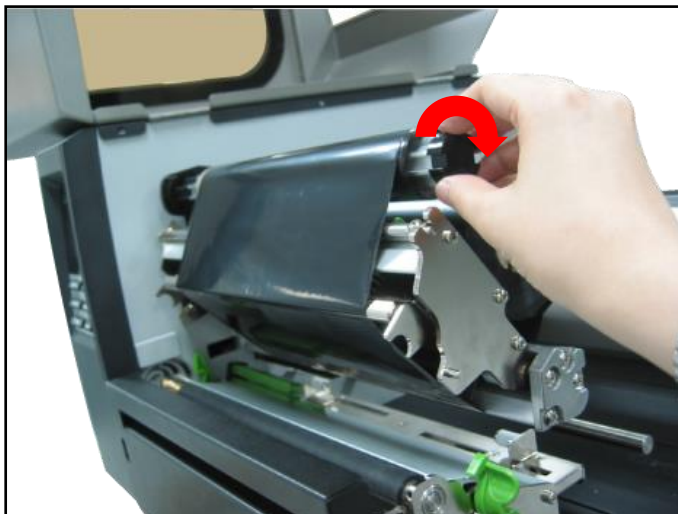

7. Close the printhead mechanism, making sure the latches are engaged properly.

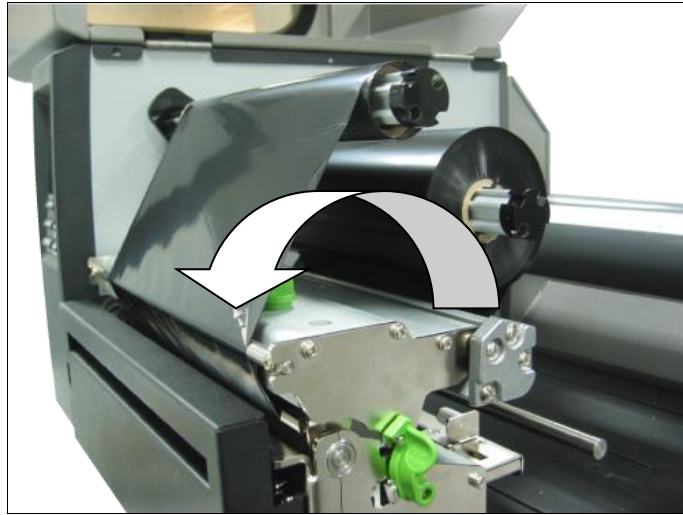

Note:

Please refer to videos on [TSC YouTube](#) or driver CD.

- **Loading path for ribbon**

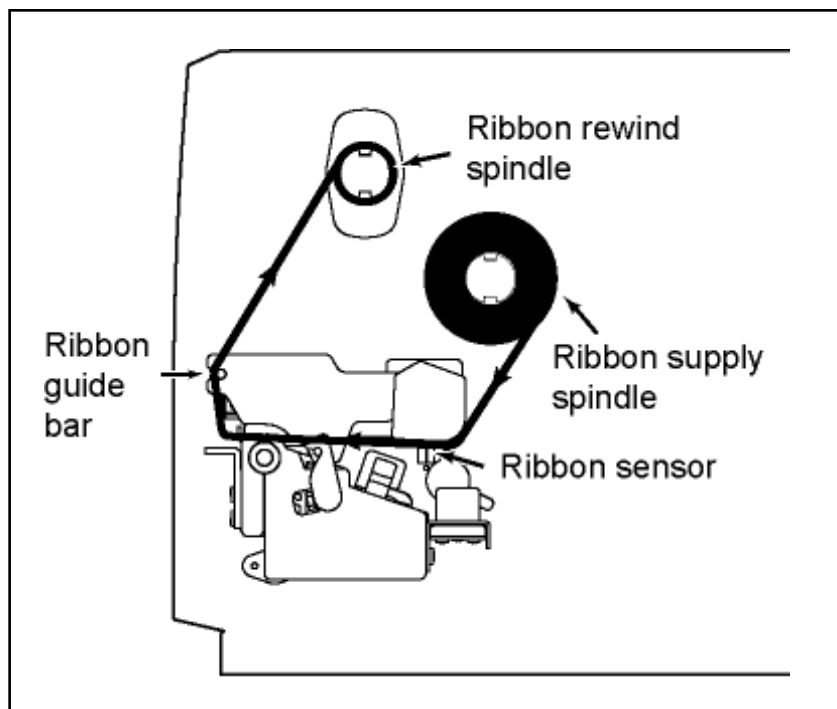

2.6 Loading Media

1. Lift printer cover open.
2. Push the print head release lever to open the print head mechanism.

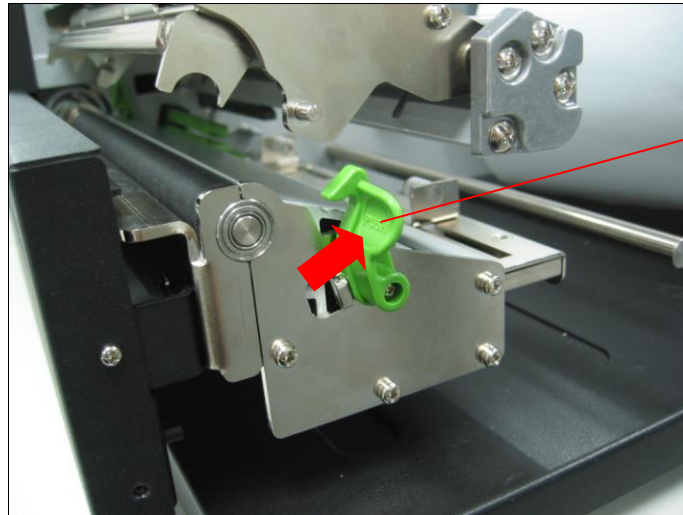

Print head
release lever

3. Remove ONE label roll guard.
4. Place media roll on label supply spindle.
5. Replace label roll guide.

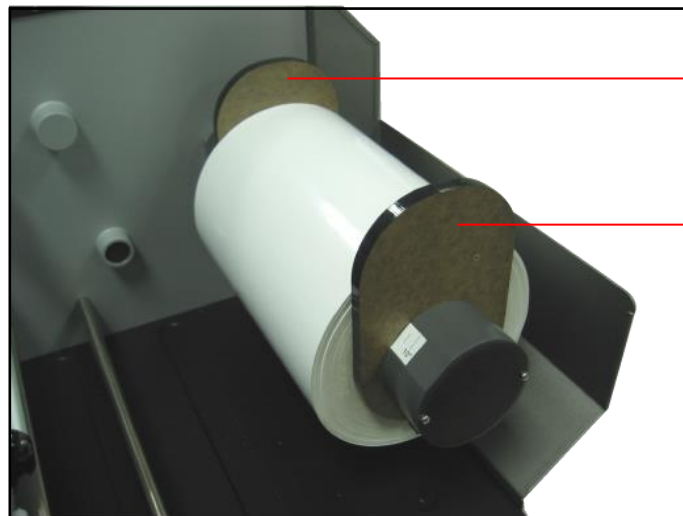

Label roll
guides

6. Pull the leading edge of the label forward through the media guide bar past media sensor, and place the leading edge onto the platen roller.

Note: Make sure the media is set at the center of spindle.

Follow these steps:



The space is reserved for the pairs of label roll guards.

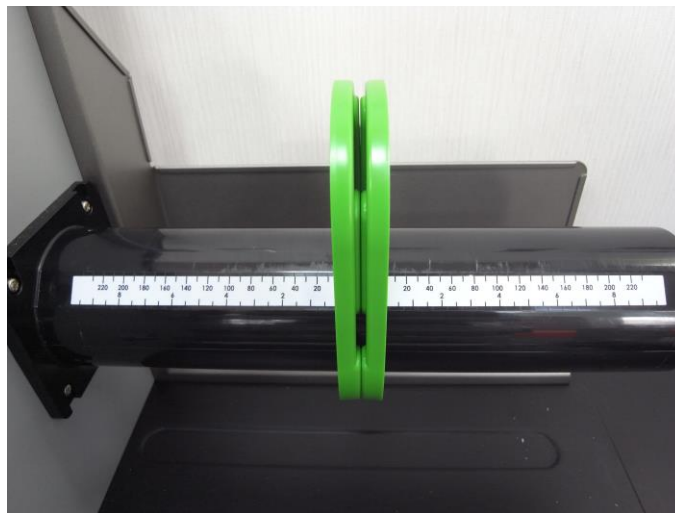

Make sure the width of the label.



Install the label and make sure the label roll guard position of each sides are the same as the length of the label.

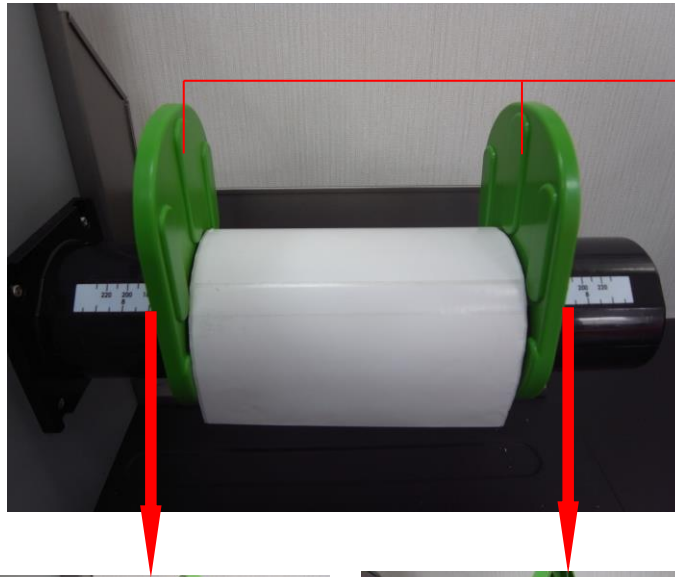

Each of the sides must face to the label.

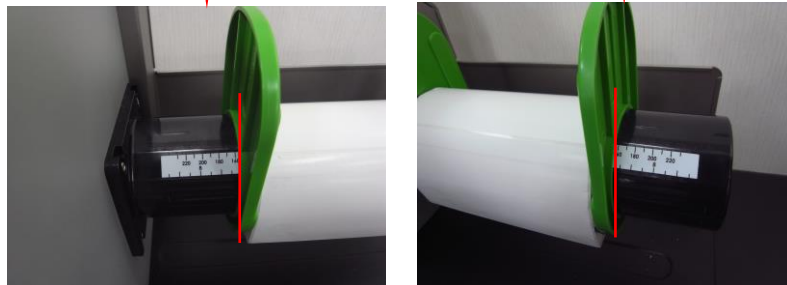

Please check the outside edge scales are both close to the label width.

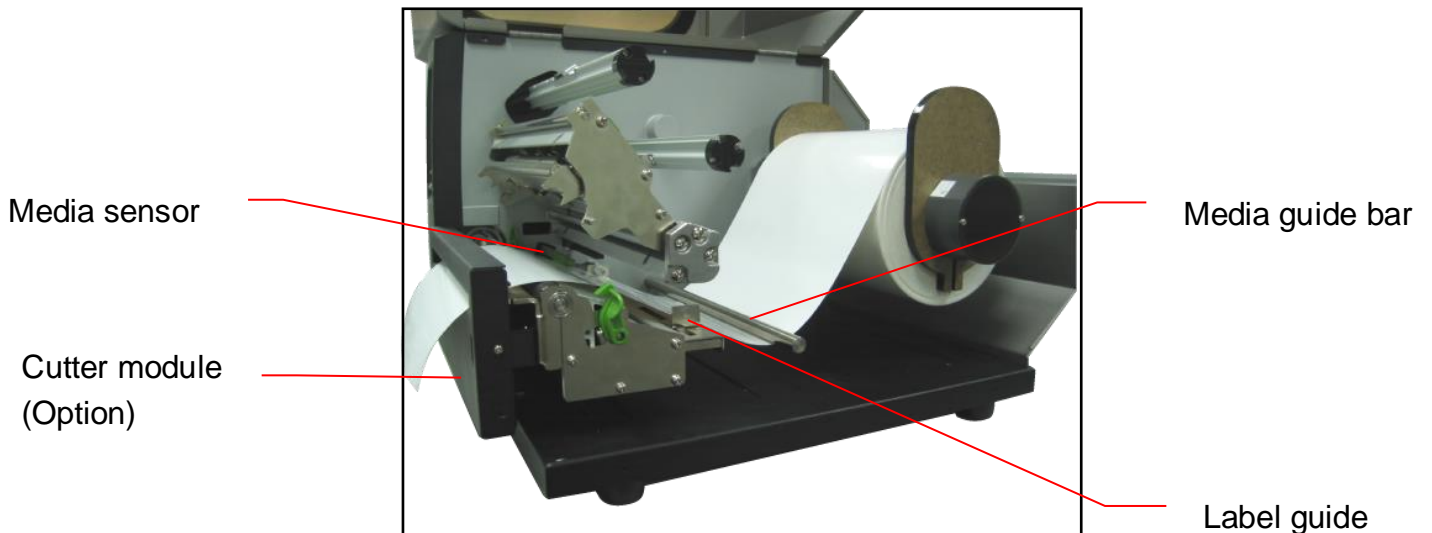

7. Adjust the label guide to fit label width.

8. Close print head mechanism, making sure the latches are engaged properly.

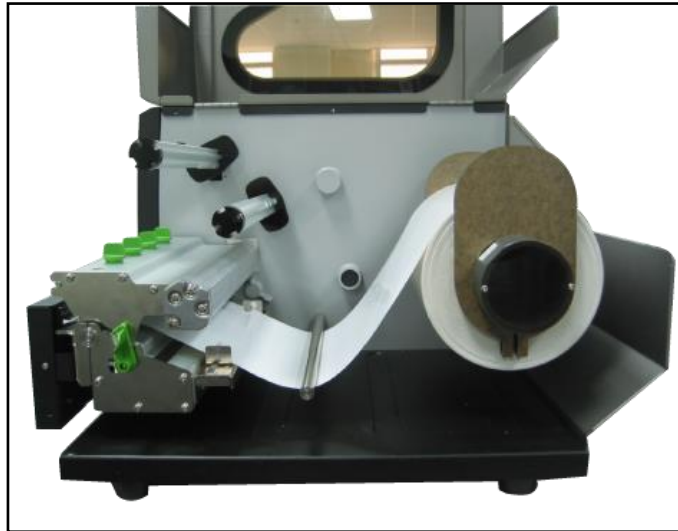

9. Using the front display panel, set media sensor type and calibrate the selected sensor.

Note:

- * Re-calibrate the gap/black-mark sensors when changing media.
- * Please refer to videos on [TSC YouTube](#) or driver CD.
- * Cutter module specification:
 Max. paper width: 215.9mm (8.5”), Life of cuts: 500,000 cuts (paper weight 200g/m²)
- * Except for the linerless cutter, all regular/heavy duty/care label cutters DO NOT cut on media with glue.

● **Loading path for roll labels**

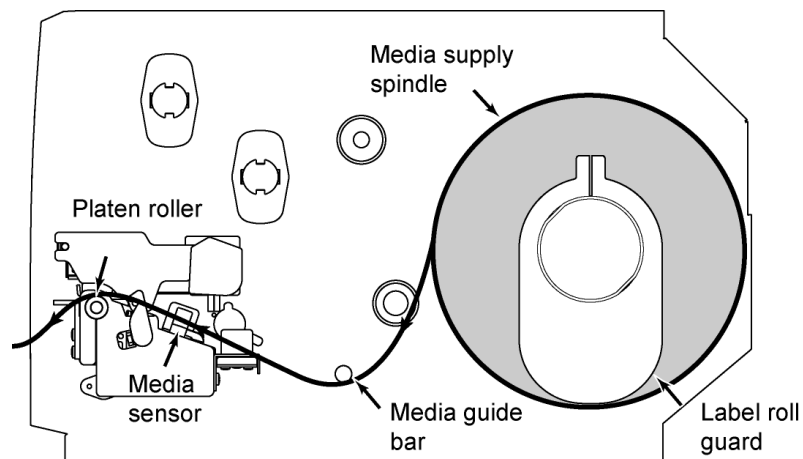

3. Menu Function

Main Menu Overview

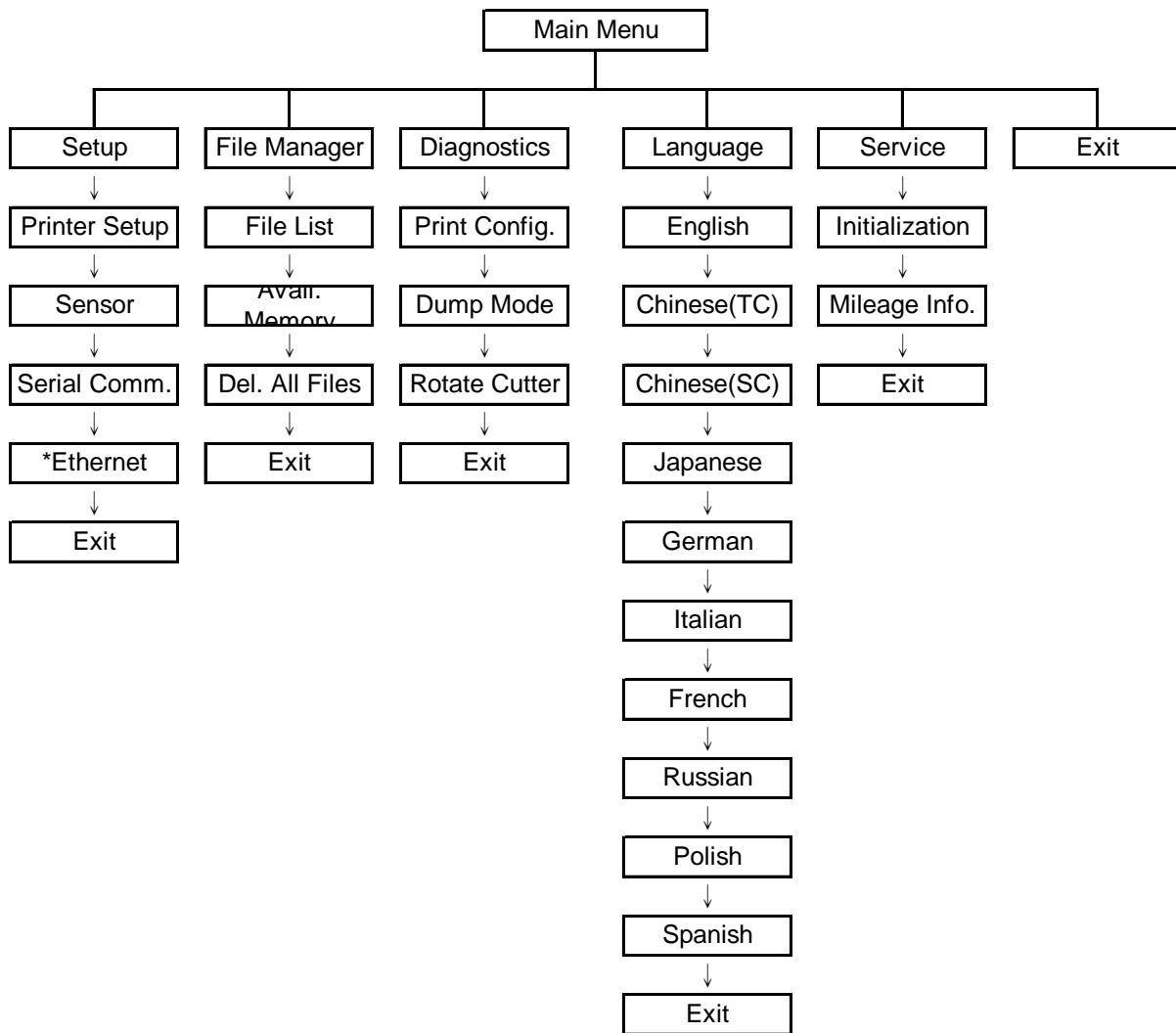

Notice:

* Ethernet function is available on the LCD display when Ethernet card is installed.

3.1 Setup Menu Overview

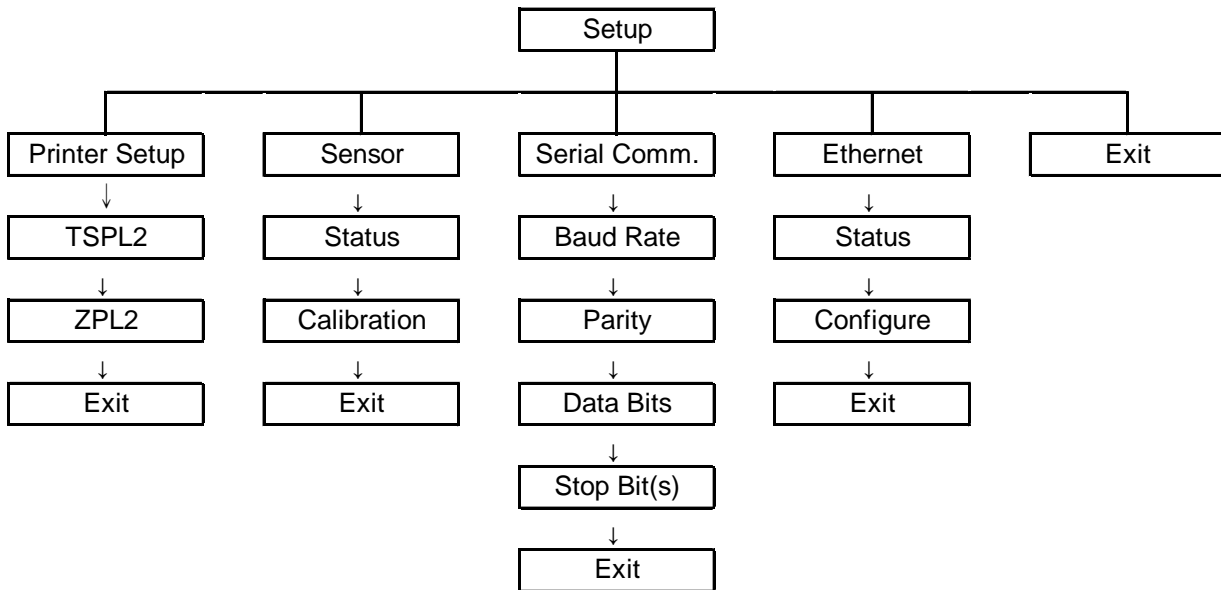

Notice:

* Ethernet function is available on the LCD display when Ethernet card is installed.

3.1.1 Printer Setup

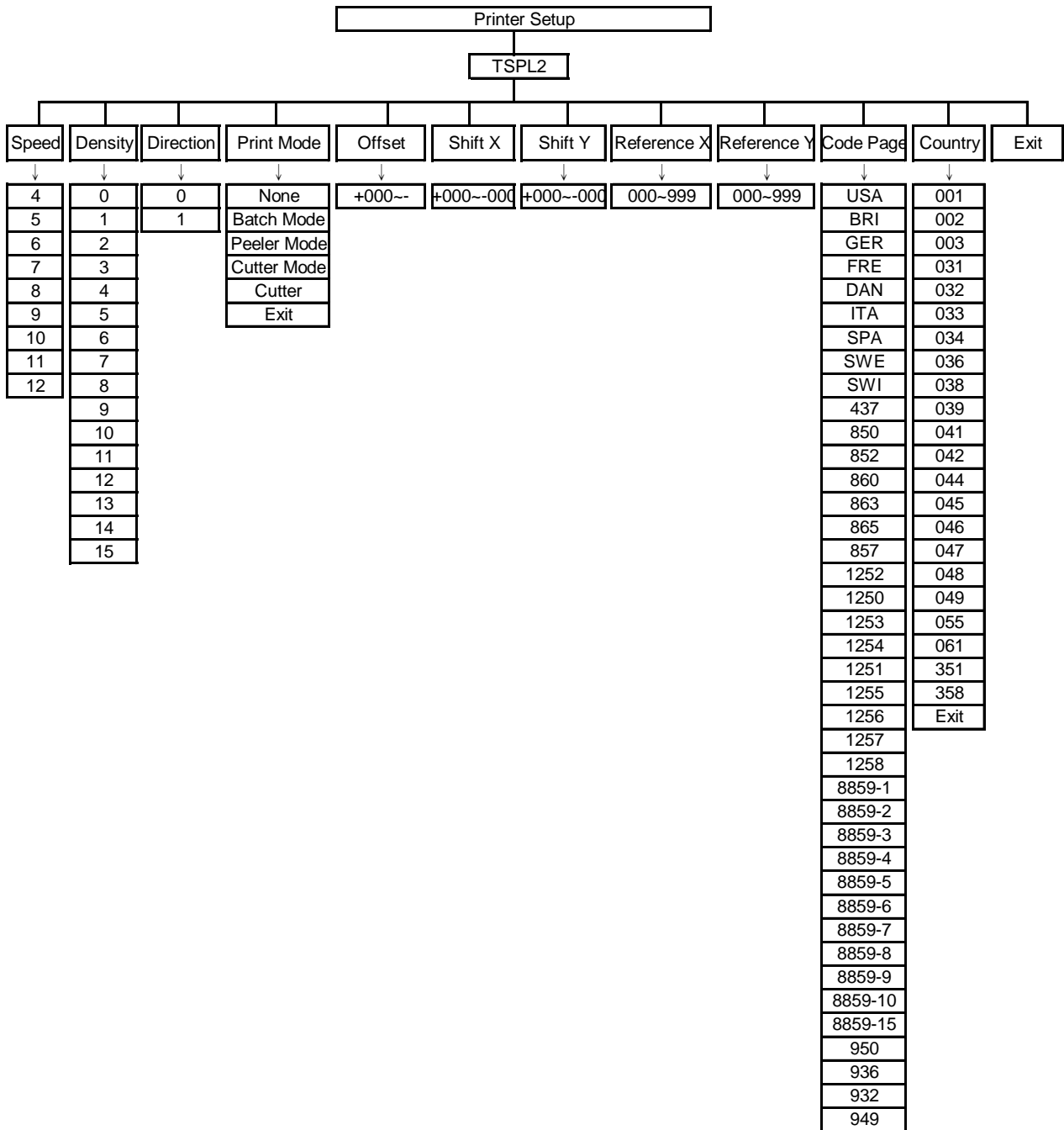

3.1.1.1 Speed:

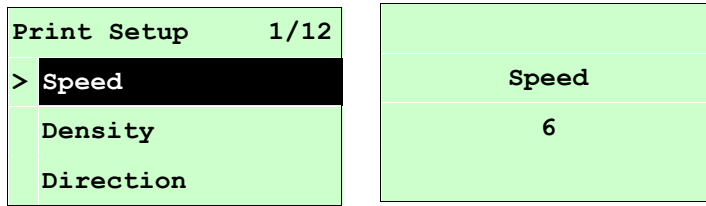

Use this option to setup print speed. The available print speed is between 4~12 ips and each increment/decrement is 1 ips. The default print speed is 6 ips.

Press **UP** key to raise the print speed, and press **DOWN** key to decrease print speed. Press **SELECT** key to set it into printer. Press **MENU** key to cancel the setting and return to the previous menu.

Note: If printing from enclosed software/driver, the software/driver will send out the SPEED command, which will overwrite the setting set from the front panel.

3.1.1.2 Density:

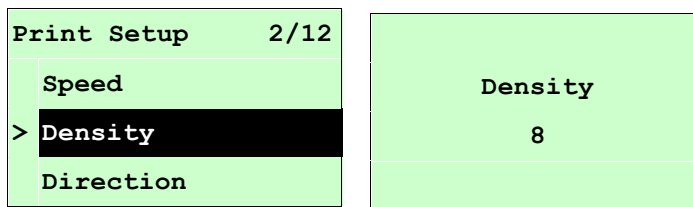

Use this option to setup printing darkness. The available setting is from 0 to 15, and the step is 1. Printer default density is 8. You may need to adjust your density based on selected media.

Press **UP** and **DOWN** to increase/decrease the printing darkness. Press **SELECT** key to enable the setting. Press **MENU** key to cancel the setting and return to the previous menu.

Note: If printing from enclosed software/driver, the software/driver will send out the DENSITY command, which will overwrite the setting set from the front panel.

3.1.1.3 Direction:

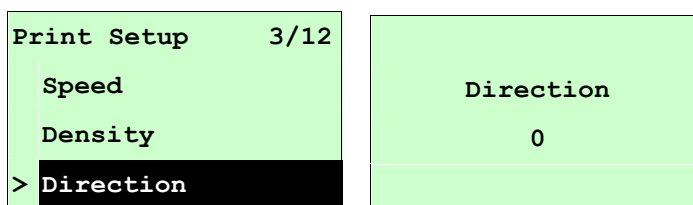

The direction setting value is either 1 or 0. Use this option to setup the printout direction. Printer default printout direction is DIRECTION 0.

Press **UP** key to set the direction as 1, and **DOWN** to set it as 0, and

SELECT key to enable the setting. Press **MENU** key to cancel the setting and return to the previous menu.

The following 2 figures are the printouts of DIRECTION 0 and 1 for your reference.

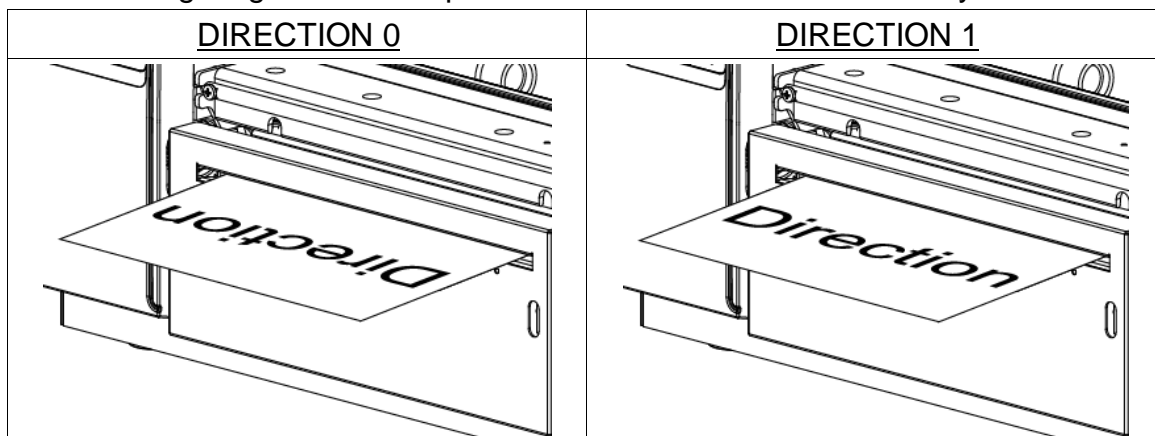

Note: If printing from enclosed software/driver, the software/driver will send out the command, which will overwrite the setting set from the front panel.

3.1.1.4 Print Mode: (None/Batch Mode/Peeler Mode/Cutter Mode/Cutter Batch)

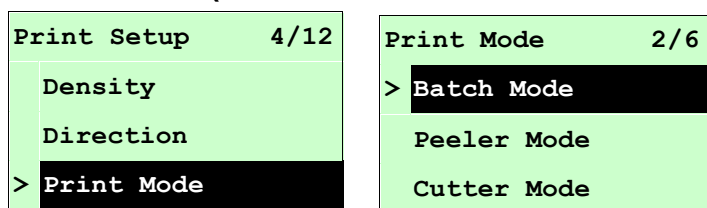

This option is used to set the print mode. Printer default setting is Batch Mode. When enter this list, the print mode in the right side of ">" icon is the printer current setting. Press **UP** and **DOWN** to select the different print mode and press **SELECT** button to enable the setting. Press **MENU** key to cancel the setting and return to the previous menu.

Printer Mode	Description
None	Next label top of form is aligned to the printhead burn line location. (Tear Off Mode)
Batch Mode	Once image is printed completely, label gap/black-mark will be fed to the tear plate location for tear away.
Peeler Mode	Enable the label peel off mode.
Cutter Mode	Enable the label cutter mode.
Cutter Batch	Cut the label once at the end of the printing job.

Note: If printing from enclosed software/driver, the software/driver will send out the command, which will overwrite the setting set from the front panel.

3.1.1.5 Offset:

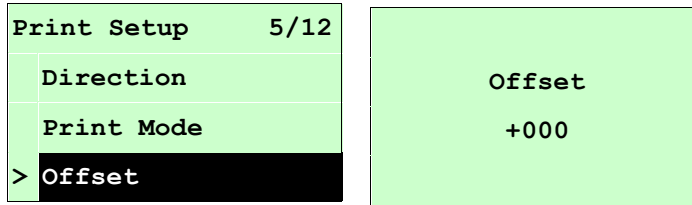

This option is used to fine tune media stop location. Press the **DOWN** Ⓞ button to move the cursor from left digit to right digit, and press the **UP** Ⓞ button to set the value from “+” to “-” or “0” to “9”. Press the **SELECT** button to set the value into printer. Press **MENU** key to cancel the setting and return to the previous menu. The default value is +000.

Note: If printing from enclosed software/driver, the software/driver will send out the OFFSET command, which will overwrite the setting set from the front panel.

3.1.1.6 Shift X & Shift Y:

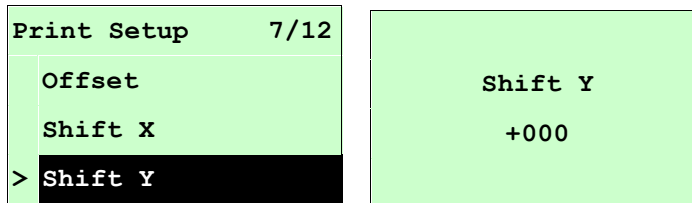

This option is used to fine tune print position. Press the **DOWN** Ⓞ button to move the cursor from left digit to right digit, and press the **UP** Ⓞ button to set the value from “+” to “-” or “0” to “9”. Press the **SELECT** button to set the value into printer. Press **MENU** key to cancel the setting and return to the previous menu. The default value is +000.

Note: If printing from enclosed software/driver, the software/driver will send out the SHIFT command, which will overwrite the setting set from the front panel.

3.1.1.6 Reference X & Reference Y:

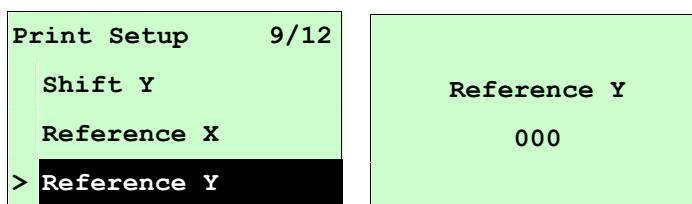

This option is used to set the origin of printer coordinate system horizontally and vertically. Press the **DOWN** ⏴ button to move the cursor from left digit to right digit, and press the **UP** ⏵ button to set the value from “0” to “9”. Press the **SELECT** button to set the value into printer. Press **MENU** key to cancel the setting and return to the previous menu. The default value is 000.

Note: If printing from enclosed software/driver, the software/driver will send out the REFERENCE command, which will overwrite the setting set from the front panel.

3.1.1.7 Code Page:

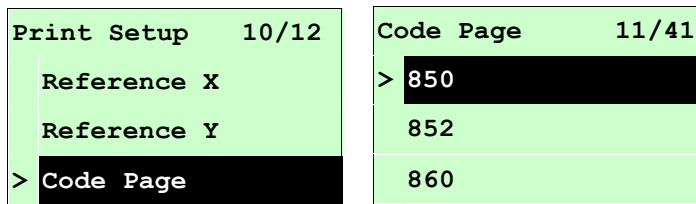

Use this option to set the code page of international character set. For more information about code page, please refer the programming manual.

When enter the code page list, the code page in the right side of ">" icon is the printer current setting.

Press the **UP** ⏴ and **DOWN** ⏵ to select the code page, and press the **SELECT** button to enable the setting. Press **MENU** key to cancel the setting and return to the previous menu.

Note: If printing from enclosed software/driver, the software/driver will send out the command, which will overwrite the setting set from the front panel.



7-bit		8-bit	
code page name	International Character Set	code page number	International Character Set
USA	USA	437	United States
BRI	British	850	Multilingual
GER	German	852	Slavic
FRE	French	860	Portuguese
DAN	Danish	863	Canadian/French
ITA	Italian	865	Nordic
SPA	Spanish		
SWE	Swedish		
SWI	Swiss		

Windows Code Page (SBCS)		Windows Code Page (DBCS)	
code page number	International Character Set	code page number	International Character Set
1252	Latin 1	950	Traditional Chinese Big5
1250	Central Europe	936	Simplified Chinese GBK
1253	Greek	932	Japanese Shift-JIS
1254	Turkish	949	Korean
1251	Cyrillic		
1255	Hebrew		
1256	Arabic		
1257	Baltic		
1258	Vietnam		

ISO Code Page		ISO Code Page	
code page name	International Character Set	code page number	International Character Set
8859-1	Latin 1	8859-7	Greek
8859-2	Latin 2	8859-9	Turkish
8859-3	Latin 3	8859-10	Latin 6
8859-4	Baltic	8859-15	Latin 9
8859-5	Cyrillic		

3.1.1.8 Country:

Print Setup 11/12	Country 1/23
Reference Y	> 001
Code Page	002
> Country	003

Use this option to set the country code for the LCD display. Press the **UP**  and **DOWN**  to select the country code, and press the **SELECT** button to set the value into printer. When enter this list, the country code in the right side of ">" icon is the printer current setting. Press  **MENU** key to cancel the setting and return to the previous menu.

Code	Country	Code	Country	Code	Country	Code	Country
001	USA	034	Spanish (Spain)	044	United Kingdom	055	Brazil
002	Canadian-French	036	Hungarian	045	Danish	061	English (International)
003	Spanish (Latin America)	038	Yugoslavian	046	Swedish	351	Portuguese
031	Dutch	039	Italian	047	Norwegian	358	Finnish
032	Belgian	041	Switzerland	048	Polish		
033	French (France)	042	Slovak	049	German		

3.1.2 Sensor

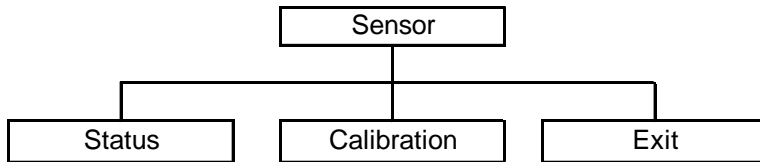

3.1.2.1 Status

This function is available to check the printer's sensor status. When enter the [Status] option, you will see following message.

Paper Len.	812
Gap Size	24
Intensity	3
Ref. Level	512

3.1.2.2 Calibration

This option is used to set the media sensor type and calibrate the selected sensor. We recommend to calibrate the sensor before printing when changing the media.

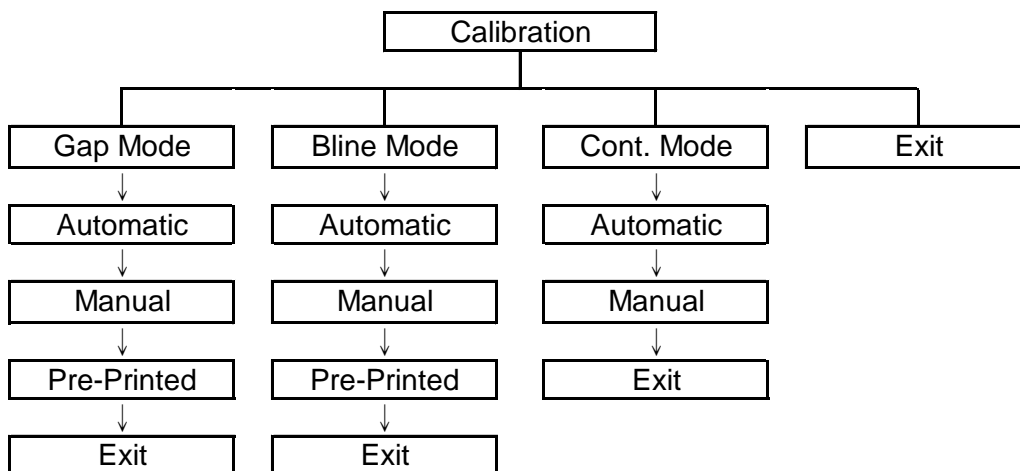

A. Gap Mode

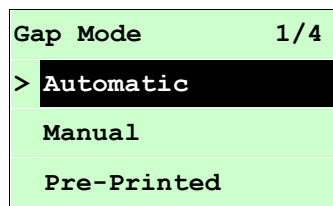
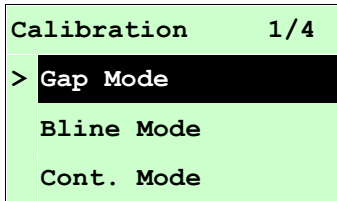

Press the **UP** ⬆ and **DOWN** ⬇ buttons to scroll the cursor to the media type and press the **SELECT** button to enter the sensor calibration mode.

Note: If printing from enclosed software/driver, the software/driver will send out the GAP or BLINE command, which will overwrite the sensor type setting set from the front panel.

A-1 Automatic

When enter the [Automatic] option, you will see following message, and printer will feed 2 to 3 gap labels to calibrate the sensor sensitivity automatically. When calibration is completed, the LCD screen will return to the previous menu.

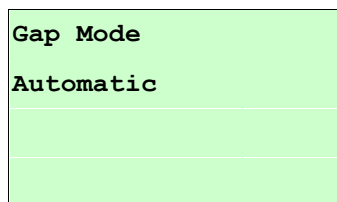

A-2 Manual

In case “Automatic” sensor calibration cannot apply to the media, please use “Manual” function to calibrate the gap sensor manually.

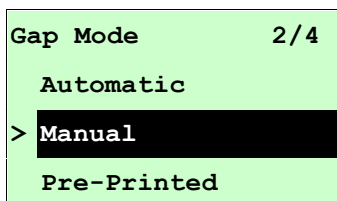

When enter [Manual] option, you will see following message. Please complete there steps :

<p>Paper Len. 00812 dot</p>	<ol style="list-style-type: none">1. Press the DOWN ⬇ button to move the cursor from left digit to right digit, and press the UP ⬆ button to set the value from “0” to “9” and the “dot/mm/ inch”. Press the SELECT button to set the paper length into the printer.
---------------------------------	---

<p style="text-align: center;">Gap Size</p> <p style="text-align: center;">0024 dot</p>	<p>2. Press the DOWN ⤵ button to move the cursor from left digit to right digit, and press the UP ⤴ button to set the value from “0” to “9” and the “dot/mm/ inch”. Press the SELECT button to set the gap size into the printer.</p>
<p>Gap Mode</p> <p>Scan Backing</p> <p>Intensity x</p> <p>Ref. Level xxx</p>	<p>3. Open the printhead mechanism, put the label backing (liner) under the media sensor. Press the SELECT button to set the value into the printer.</p>
<p>Gap Mode</p> <p>Scan Paper</p> <p>Intensity x</p> <p>Ref. Level xxx</p>	<p>4. Then, Put the label with liner under the media sensor. Press the SELECT button to set the value into the printer.</p>
<p>Gap Mode</p> <p>Complete</p> <p>Intensity x</p> <p>Ref. Level xxx</p>	<p>5. The gap sensor calibration is complete. Press the SELECT button the LCD screen will return to the previous menu.</p>

A-3 Pre-Printed

This function can set the paper length and gap size before auto-calibrate the sensor sensitivity. It can to get the sensor sensitivity accurately.

<p>Gap Mode 3/4</p> <p>Manual</p> <p>> Pre-Printed</p> <p>Exit</p>
--

When enter [Pre-Printed] option, you will see following message. Please complete there steps :

<p style="text-align: center;">Paper Len.</p> <p style="text-align: center;">00812 dot</p>	<p>1. Press the DOWN ⤵ button to move the cursor from left digit to right digit, and press the UP ⤴ button to set the value from “0” to “9” and the “dot/mm/ inch”. Press the SELECT button to set the paper length into the printer.</p>
<p style="text-align: center;">Gap Size</p> <p style="text-align: center;">0024 dot</p>	<p>2. Press the DOWN ⤵ button to move the cursor from left digit to right digit, and press the UP ⤴ button to set the value from “0” to “9” and the “dot/mm/ inch”. Press the SELECT button to set the gap size into the</p>

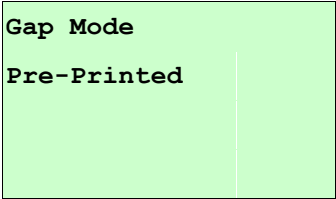
	printer.
 The image shows a green LCD screen with the text "Gap Mode" and "Pre-Printed" in black. A vertical white line is positioned to the right of the text.	3. Then, printer will feed labels to calibrate the sensor sensitivity automatically. When calibration is completed, the LCD screen will return to the previous menu.

B. Bline Mode

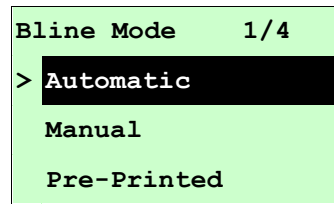
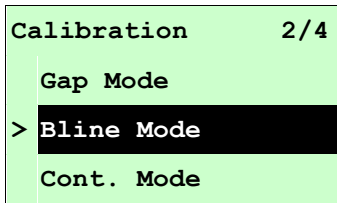

Press the **UP** ⬆ and **DOWN** ⬇ buttons to scroll the cursor to the sensor type. Press the **SELECT** button to enter the black-mark sensor calibration mode.

B-1 Automatic

When enter the [Automatic] option, you will see following message and printer will feed the black-mark label to calibrate the sensor sensitivity automatically. When calibration process is completed, the LCD screen will return to the previous menu.

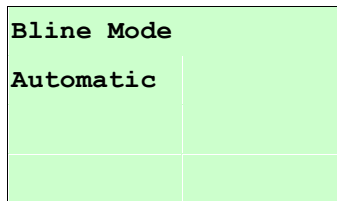

B-2 Manual

In case “Automatic” sensor calibration cannot apply to the media, please use “Manual” function to calibrate the bline sensor manually.

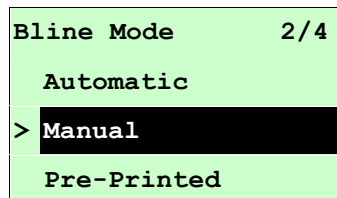

When enter [Manual] option, you will see following message. Please complete there steps :

<p>Paper Len. 00151 dot</p>	<p>1. Press the DOWN ⬇ button to move the cursor from left digit to right digit, and press the UP ⬆ button to set the value from “0” to “9” and the “dot/mm/ inch”. Press the SELECT button to set the paper length into the printer.</p>
<p>Bline Size 0024 dot</p>	<p>2. Press the DOWN ⬇ button to move the cursor from left digit to right digit, and press the UP ⬆ button to set the value from “0” to “9” and the “dot/mm/ inch”. Press the SELECT button to set the bline size into the printer.</p>

<pre> Bline Mode Scan Mark Intensity x Ref. Level xxx </pre>	<p>3. Open the printhead mechanism, put the black-mark under the media sensor. Press the SELECT button to set the value into the printer.</p>
<pre> Bline Mode Scan Paper Intensity x Ref. Level xxx </pre>	<p>4. Then, put the label without black-mark under the media sensor. Press the SELECT button to set the value into the printer.</p>
<p>Note: Normally, the value of "Ref. Level" for mark should be larger than paper for over 128. If the media sensor fails to do so, you have to manually change the Intensity by pressing UP ⤴ and DOWN ⤵ to reach the above value.</p>	
<pre> Bline Mode Complete Intensity x Ref. Level xxx </pre>	<p>5. The bline sensor calibration is complete. Press the SELECT button the LCD screen will return to the previous menu.</p>

B-3 Pre-Printed

This function can set the paper length and gap size before auto-calibrate the sensor sensitivity. It can to get the sensor sensitivity accurately.

<pre> Bline Mode 3/4 </pre>
<pre> Manual </pre>
<pre> > Pre-Printed </pre>
<pre> Exit </pre>

When enter [Pre-Printed] option, you will see following message. Please complete there steps :

<pre> Paper Len. 00812 dot </pre>	<p>1. Press the DOWN ⤵ button to move the cursor from left digit to right digit, and press the UP ⤴ button to set the value from "0" to "9" and the "dot/mm/ inch". Press the SELECT button to set the paper length into the printer.</p>
<pre> Bline Size 0024 dot </pre>	<p>2. Press the DOWN ⤵ button to move the cursor from left digit to right digit, and press the UP ⤴ button to set the value from "0" to "9" and the "dot/mm/ inch". Press the SELECT button to set the bline size into the printer.</p>



Bline Mode

Pre-Printed

3. Then, printer will feed labels to calibrate the sensor sensitivity automatically. When calibration is completed, the LCD screen will return to the previous menu.

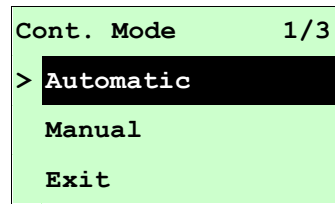
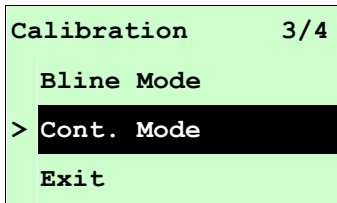
C. Cont. Mode



Press the **UP**  and **DOWN**  buttons to scroll the cursor to the sensor type. Press the **SELECT** button to enter the black-mark sensor calibration mode.

C-1 Automatic

When enter the [Automatic] option, you will see following message and printer will calibrate the sensor sensitivity automatically. When calibration process is completed, the LCD screen will return to the previous menu.

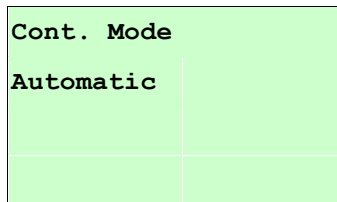

C-2 Manual

In case “Automatic” sensor calibration cannot apply to the media, please use “Manual” function to calibrate the sensor manually.

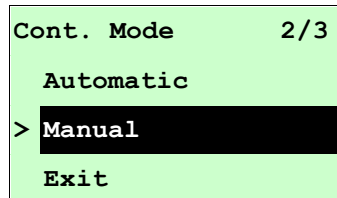

When enter [Manual] option, you will see following message. Please complete there steps :

<pre> Cont. Mode Remove Label Intensity x Ref. Level xxx </pre>	<p>1. Remove the continuous label. Press the SELECT button to set the value into the printer.</p>
<pre> Cont. Mode Scan Paper Intensity x Ref. Level xxx </pre>	<p>2. Then, put the continuous label under the media sensor. Press the SELECT button to set the value into the printer.</p>

Cont. Mode	
Complete	
Intensity	x
Ref. Level	xxx

3. The sensor calibration is complete.
Press the **SELECT** button the LCD screen will return to the previous menu.

3.1.3 Serial Comm.

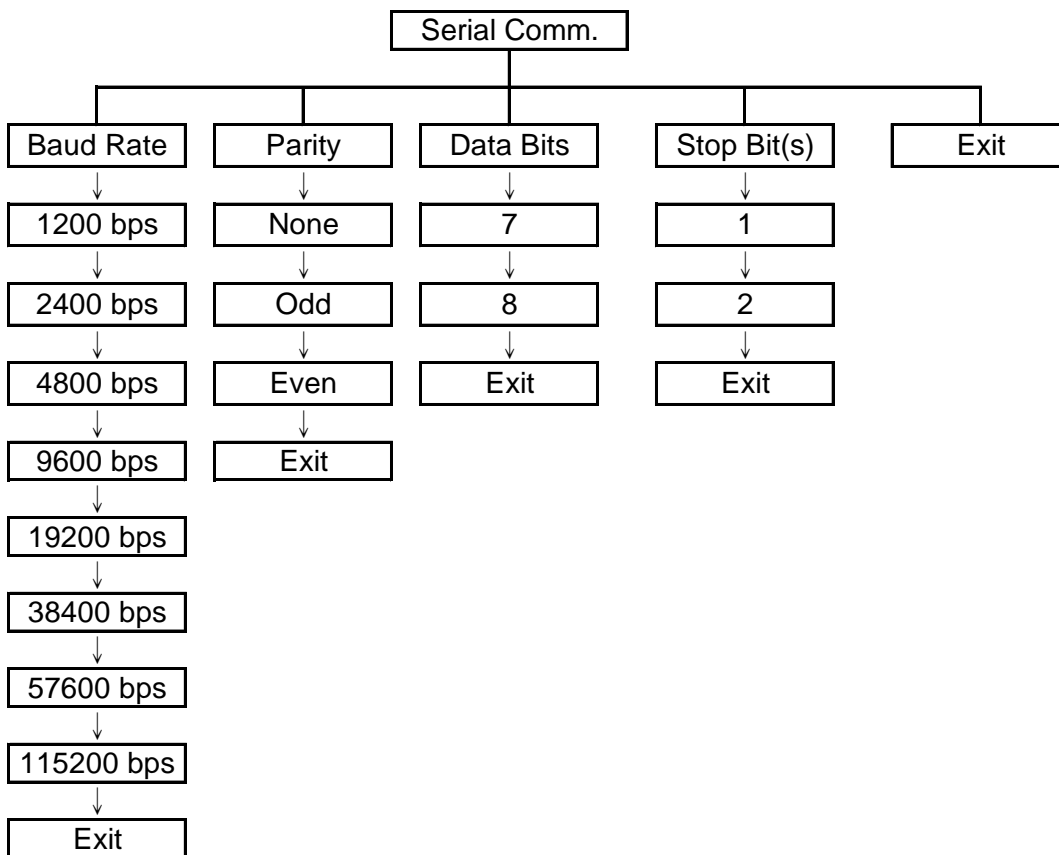

3.1.3.1 Baud Rate

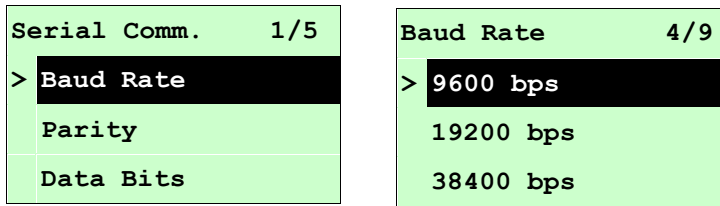

This option is used to set the RS-232 baud rate. The default setting is 9600 bps. Press **UP** ⬆ and **DOWN** ⬇ buttons to select the different baud rate and press **SELECT** button to set the value into printer. When you enter this list, the baud rate value in the right side of ">" icon is the current setting in the printer. Press **MENU** key to cancel the setting and return to the previous menu.

3.1.3.2 Parity

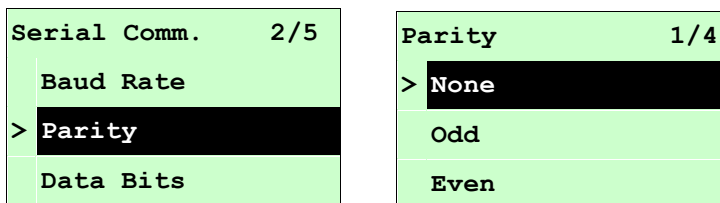

This option is used to set the RS-232 parity. The default setting is "None". Press **UP** ⬆ and **DOWN** ⬇ buttons to select the different parity and press **SELECT** button to set the value into printer. When you enter this list, the parity in the right side of ">" is the printer current setting. Press **MENU** key to cancel the setting and return to the previous menu.

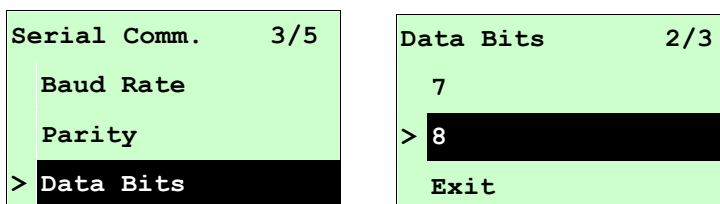

3.1.3.3 Data Bits:



This option is used to set the RS-232 Data Bits. The default setting is "8" data bits. Press **UP** ⬆ and **DOWN** ⬇ buttons to select the different Data Bits and press **SELECT** button to set the value into printer. When you enter this list, the Data Bits in the right side of ">" icon is the printer current setting. Press **MENU** key to cancel the setting and return to the previous menu.

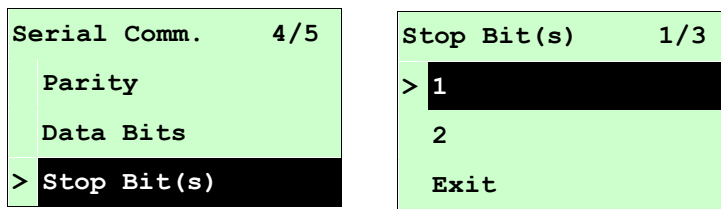

3.1.3.4 Stop Bit(s):



This option is used to set the RS-232 Stop Bits. The default setting is “1” stop bit. Press **UP**  and **DOWN**  buttons to select the different Stop Bits and press **SELECT** button to set the value into printer. When you enter this list, the option in the right side of ">" icon is the printer current setting. Press  **MENU** key to cancel the setting and return to the previous menu.

3.1.4 Ethernet

Use this menu to configure internal Ethernet configuration check the printer's Ethernet module status, and reset the Ethernet module. This function is available on the LCD display when Ethernet card is installed.

Press **UP**  and **DOWN**  buttons to select the different options and press **SELECT** button to enter the option. Press  **MENU** key to cancel the setting and return to the previous menu.

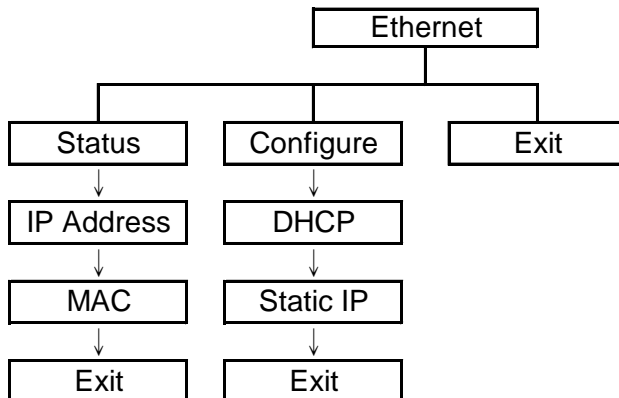

3.1.4.1 Status: (IP Address / MAC)

Use this menu to check the Ethernet setting status.

3.1.4.1.1 IP Address

```
Ethernet 1/3
> Status
  Configure
  Exit
```

```
Status 1/3
> IP Address
  MAC
  Exit
```

```
IP Address
0.0.0.0
Subnet Mask
0.0.0.0
Gateway
0.0.0.0
```

The IP address information will be shown on the LCD display. Please press **SELECT** or  **MENU** button to return to the previous menu.

3.1.4.1.2 MAC

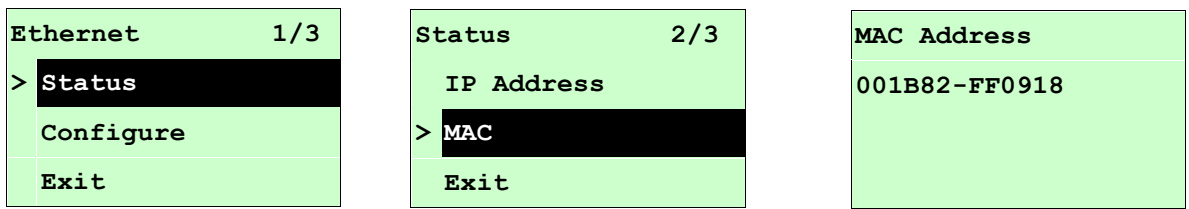

The MAC address information will be shown on the LCD display. Please press **SELECT** or **MENU** button to return to the previous menu.

3.1.4.2 Configure: (DHCP / Static IP)

Use this menu to set the printer's DHCP and Static IP.

3.1.4.2.1 DHCP

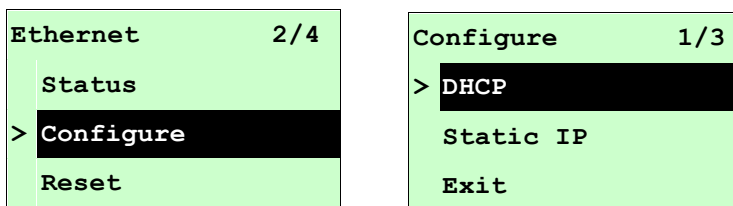

Press **UP** and **DOWN** buttons to select the DHCP function and press **SELECT** to enter. Press **MENU** key to cancel the setting and return to the previous menu.

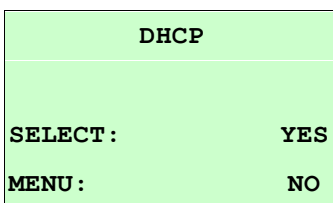

Press **SELECT** button the printer will set DHCP and restart to reset the setting. Press **MENU** button to return to the previous menu.

3.1.4.2.2 Static IP

Use this menu to set the printer's IP address, subnet mask and gateway.

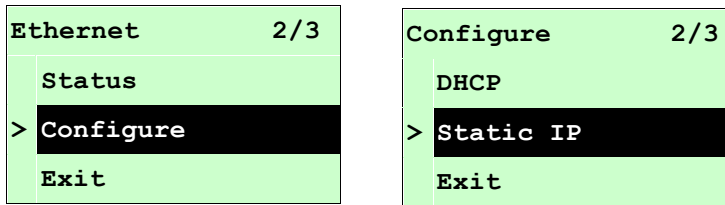

Press **UP** and **DOWN** buttons to select the different options and press **SELECT** button to enter the option. Press **MENU** key to cancel the setting and return to the previous menu.

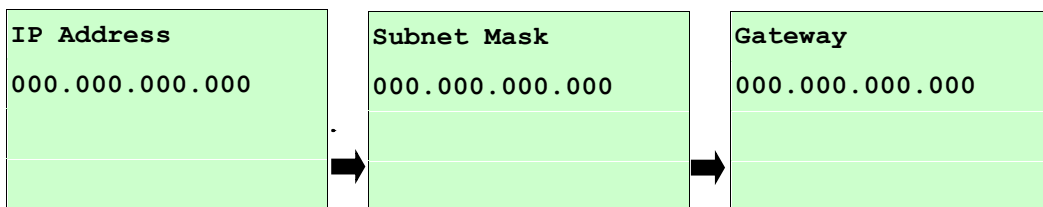

Press **DOWN** button to move the cursor from left to right digits and press the **UP** button to scroll the value from "0" to "9". Press **SELECT** button to next setting.

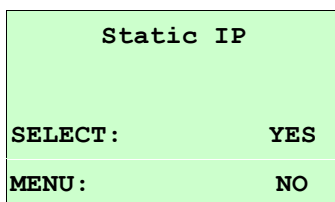

Press the **SELECT** button printer will restart to reset the Ethernet module setting. Press **MENU** key to cancel the setting.

3.2 File Manager

This feature is used to check the printer available memory and file list.

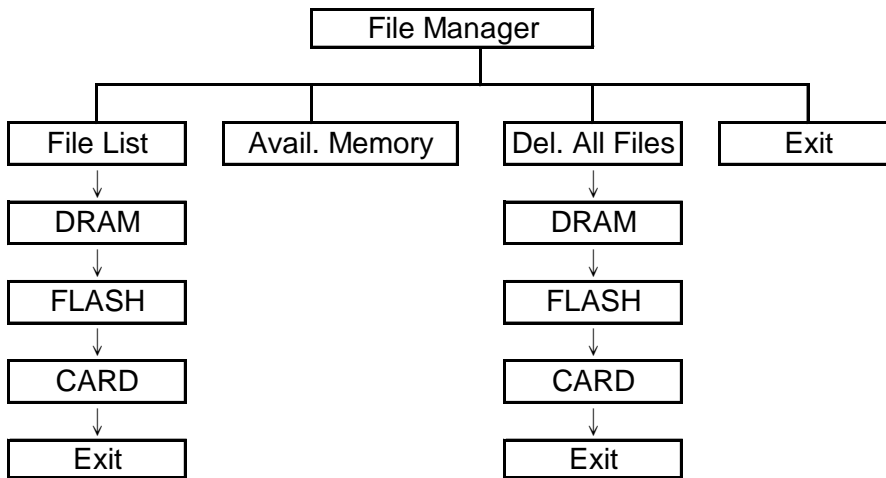

3.2.1 File List

Use this menu to show, delete and run (.BAS) the files saved in the printer DRAM/Flash/Card memory.

To show the files :

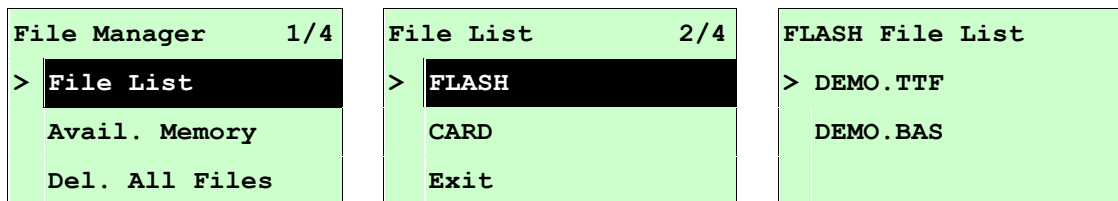

To delete the file : Please follow the order to press the **DOWN** button.

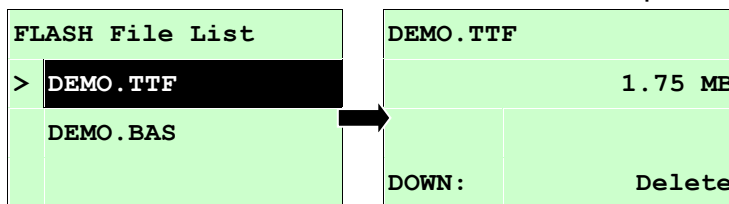

To run the file (.BAS) : Please follow the order to press the **SELECT** button.

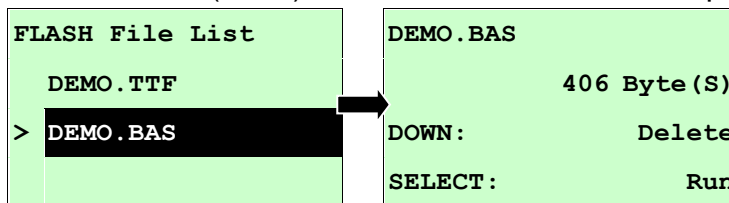

3.2.2 Avail. Memory

Use this menu to show available memory space.

```

File Manager      2/4
  File List
> Avail. Memory
  Del. All Files

```

```

Avail. Memory
DRAM:             256 KB
FALSH:           6656 KB
CARD:             0 KB

```

3.2.3 Del. All Files

Use this menu to delete all files. Press **SELECT** button to delete all files in the device.

Press **MENU** to cancel deleting files and go back to previous menu.

```

File Manager      3/4
  File List
  Avail. Memory
> Del. All File

```

```

File List        1/4
> DRAM
  FALSH
  CARD

```

```

Del. All Files

SELECT:          YES
MENU:            NO

```

Self-test printout (with printer firmware V7.0 and later version)

SYSTEM INFORMATION		

MODEL:	XXXXXX	Model name
FIRMWARE:	X.XX	F/W version
CHECKSUM:	XXXXXXXX	Firmware checksum
S/N:	XXXXXXXXXXXX	Printer S/N
TCF:	NO	TSC configuration file
DATE:	1970/01/01	System date
TIME:	00:04:18	System time
NON-RESET:	110 m (TPH)	Printed mileage (meter)
RESET:	110 m (TPH)	
NON-RESET:	0 (CUT)	Cutting counter
RESET:	0 (CUT)	

PRINTING SETTING		

SPEED:	5 IPS	Print speed (inch/sec)
DENSITY:	8.0	Print darkness
WIDTH:	4.00 INCH	Label size (inch)
HEIGHT:	4.00 INCH	Gap distance (inch)
GAP:	0.00 INCH	Gap/black mark sensor intension
INTENSION:	5	Code page
CODEPAGE:	850	Country code
COUNTRY:	001	

Z SETTING		ZPL setting information

DARKNESS:	16.0	Print darkness
SPEED:	4 IPS	Print speed (inch/sec)
WIDTH:	4.00 INCH	Label size
TILDE:	7EH (~)	Control prefix
CARET:	5EH (^)	Format prefix
DELIMITER:	2CH (,)	Delimiter prefix
POWER UP:	NO MOTION	Printer power up motion
HEAD CLOSE:	NO MOTION	Printer head close motion

RS232 SETTING		

BAUD:	9600	RS232 serial port configuration
PARITY:	NONE	
DATA BIT:	8	
STOP BIT:	1	

Note:
ZPL is emulating for Zebra® language.

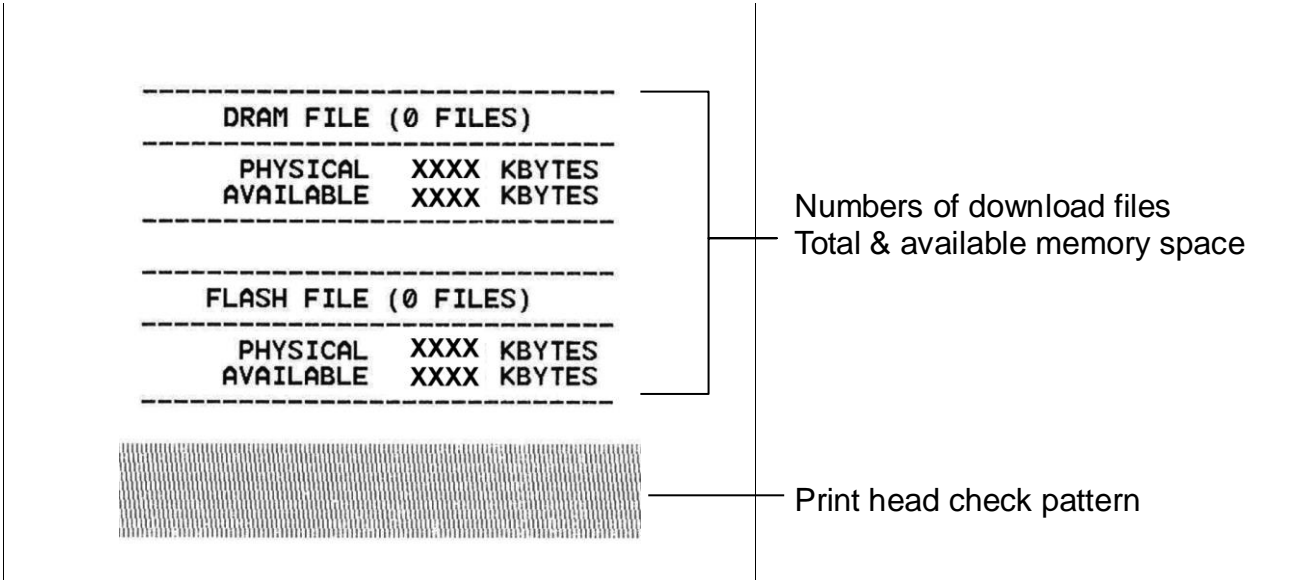

3.3.2 Dump Mode

Captures the data from the communications port and prints out the data received by printer. In the dump mode, all characters will be printed in 2 columns as following. The left side characters are received from your system and right side data are the corresponding hexadecimal value of the characters. It allows users or engineers to verify and debug the program.

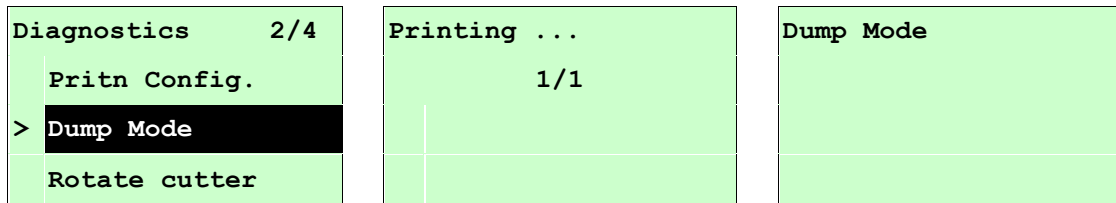

Note:

- 1. Dump mode requires 4" wide paper width.**
- 2. Turn off / on the power to resume printer for normal printing.**
- 3. Press FEED button to back to the previous menu.**

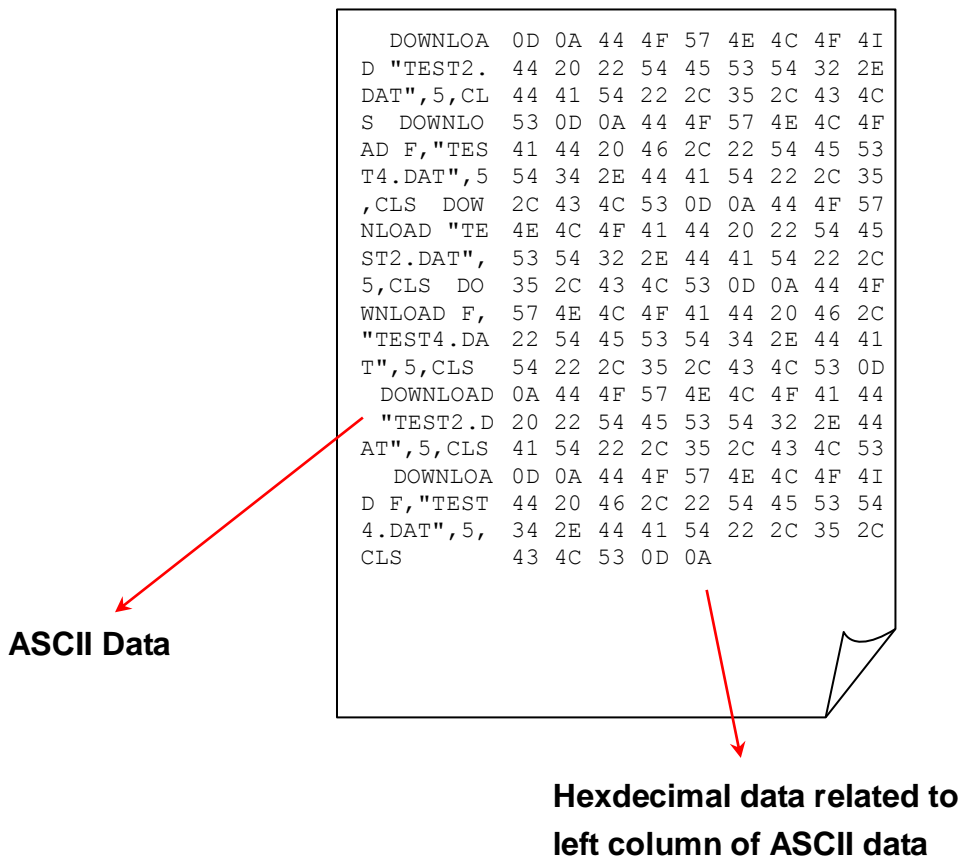

3.3.3 Rotate Cutter



In case paper is jammed in the cutter, this feature can rotate the cutter blade forward or reverse direction, which is helpful to remove the jammed paper easily from the cutter.

Diagnostics 3/4	UP: Fwd.
Print Config.	DOWN: Rev.
Dump Mode	
> Rotate Cutter	MENU: Exit

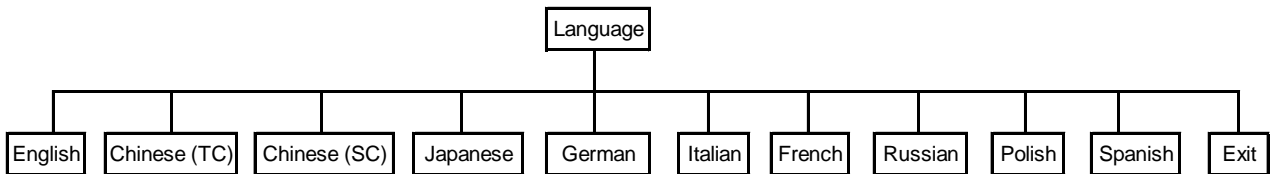
3.4 Language



This option is used to setup the language on LCD display.

Press **UP**  and **DOWN**  buttons to scroll the cursor to desire language and press **SELECT** button to select this option. Press  **MENU** key to cancel the setting and return to the previous menu. The default language setting is English.

3.5 Service

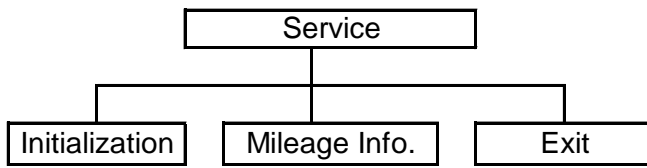

This feature is used to restore printer settings to defaults and display printer mileage information.

3.5.1 Initialization

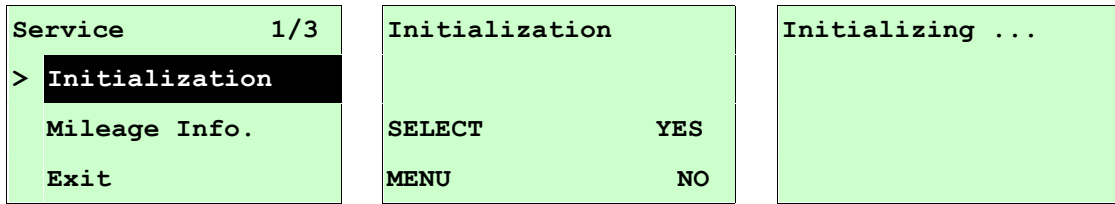

The printer settings are restored to defaults as below once printer is initialized.

Note :

When printer initialization is done, please calibrate the gap or black-mark sensor before printing.

Parameter	Default setting
Speed	2 IPS (50.8 mm/sec)
Density	8.0
Label width	8.64"(219.5mm)
Label height	4.00"(101.6mm)
Sensor type	Gap sensor
Gap setting	0.12"(3.0mm)
Print direction	0
Reference point	0,0(upper left corner)
Offset	0
Print mode	Batch mode
Serial port settings	9600 bps, none parity, 8 data bits, 1 stop bit
Code page	850
Country code	001
Clear flash memory	No
Shift X	0
Shift Y	0
Gap sensor	3 (Will be reset. Need to re-calibrate the gap)

sensitivity	
Bline sensor sensitivity	2 (Will be reset. Need to re-calibrate the gap)
Language	English
IP address	DHCP

3.5.2 Mileage Info.

Use this option to check the printed mileage (displayed in meter).

Service 1/3	Mileage: (m)
Initialization	4016
> Mileage Info.	Labels: (pcs.)
Exit	51698

4. Diagnostic Tool

The Diagnostic Utility toolbox allows users to explore and change printer status and settings. Download graphics, fonts, firmware to the printer can be accomplished using this utility, as well as creating bitmap fonts. The Diagnostics can be used to send additional commands to the printer and troubleshoot any issues during use.

Note: The Diagnostic Utility requires printer firmware V6.00 and above.

4.1 Start the Diagnostic Tool

1. Double click the Diagnostic tool icon  `DiagTool.exe` to start the software.
2. There are four features (Printer Configuration, File Manager, Bitmap Font Manager, Command Tool) included in the Diagnostic utility.

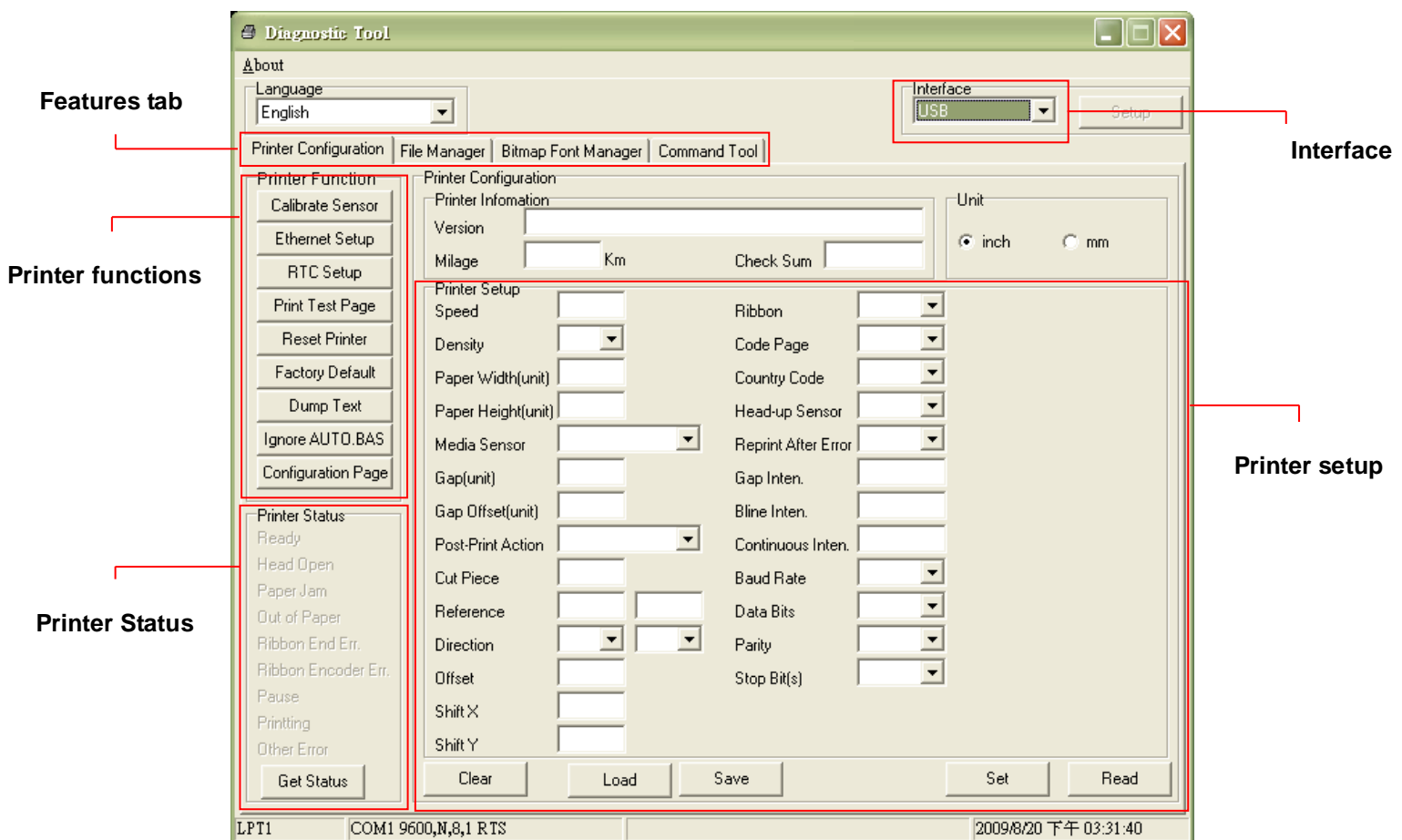

4.2 Printer Function (Calibrate sensor, Ethernet setup, RTC setup.....)

1. Select the PC interface connected with bar code printer.
2. Click the “Function” button to setting.
3. The detail functions in the Printer Function Group are listed as below.

	Function	Description
Printer Function		
Calibrate Sensor	Calibrate Sensor	Calibrate the sensor specified in the Printer Setup group media sensor field
Ethernet Setup	Ethernet Setup	Setup the IP address, subnet mask, gateway for the on board Ethernet (Please refer to next section)
RTC Setup	RTC Time	Synchronize printer Real Time Clock with PC
Print Test Page	Print Test Page	Print a test page
Reset Printer	Reset Printer	Reboot printer
Factory Default	Factory Default	Initialize the printer and restore the settings to factory default.
Dump Text	Dump Text	To activate the printer dump mode.
Ignore AUTO.BAS	Ignore AUTO.BAS	Ignore the downloaded AUTO.BAS program
Configuration Page	Configuration Page	Print printer configuration

Note:

For more information about Diagnostic Tool, please refer to the diagnostic utility quick start guide in the CD disk \ Utilities directory.

5 Setting Ethernet by Diagnostic Utility

The Diagnostic Utility is enclosed in the CD disk \Utilities directory. Users can use Diagnostic Tool to setup the Ethernet by RS-232, USB and Ethernet interfaces. The following contents will instruct users how to configure the Ethernet by these three interfaces.

5.1 Using USB interface to setup Ethernet interface

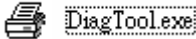
1. Connect the USB cable between the computer and the printer.
2. Turn on the printer power.
3. Start the Diagnostic Utility by double clicking on the  icon.
Note: This utility works with printer firmware V6.00 and later versions.
4. The Diagnostic Utility default interface setting is USB interface. If USB interface is connected with printer, no other settings need to be changed in the interface field.

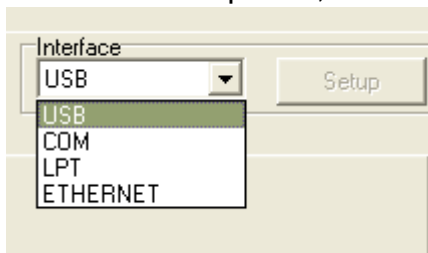

5. Click on the “Ethernet Setup” button from “Printer Function” group in Printer Configuration tab to setup the IP address, subnet mask and gateway for the on board Ethernet.

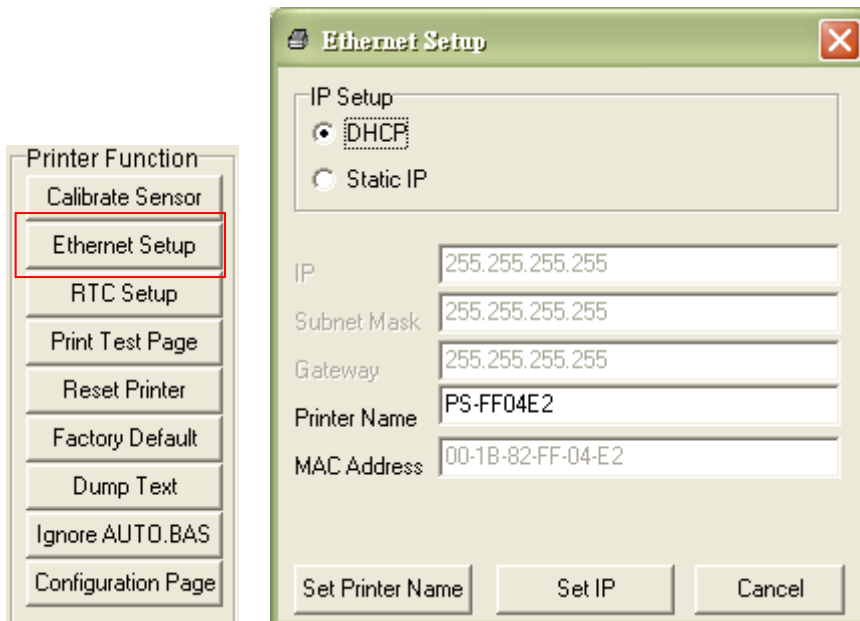

5.2 Using RS-232 interface to setup Ethernet interface

1. Connect the computer and the printer with a RS-232 cable.
2. Turn on the printer power.
3. Start the Diagnostic Utility by double clicks on the  `DiagTool.exe` icon.
Note: This utility works with printer firmware V6.00 and later versions.
4. Select “COM” as interface then click on the “Setup” button to setup the serial port baud rate, parity check, data bits, stop bit and flow control parameters.

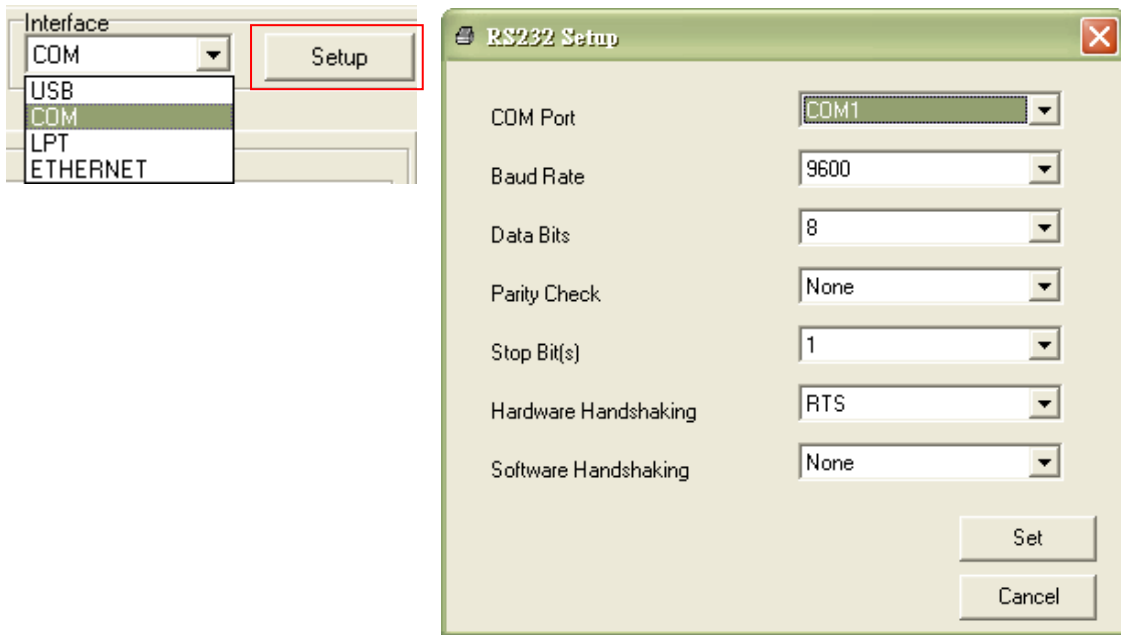

5. Click on the “Ethernet Setup” button from printer function of Printer Configuration tab to setup the IP address, subnet mask and the gateway for the on board Ethernet.

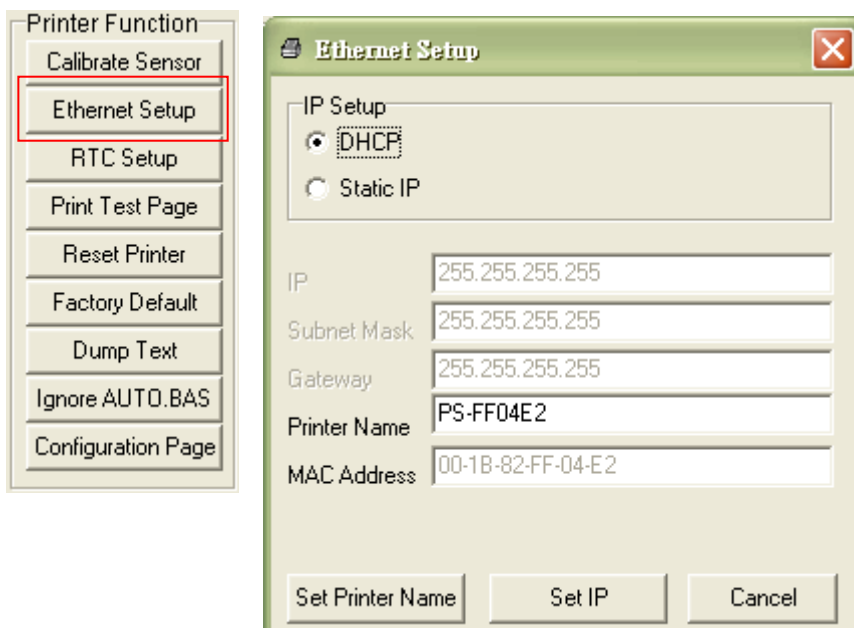

5.3 Using Ethernet interface to setup Ethernet interface

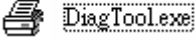
1. Connect the computer and the printer to the LAN.
2. Turn on the printer power.
3. Start the Diagnostic Utility by double clicks on the  icon.
Note: This utility works with printer firmware V6.00 and later versions.
4. Select “Ethernet” as the interface then click on the “Setup” button to setup the IP address, subnet mask and gateway for the on board Ethernet.

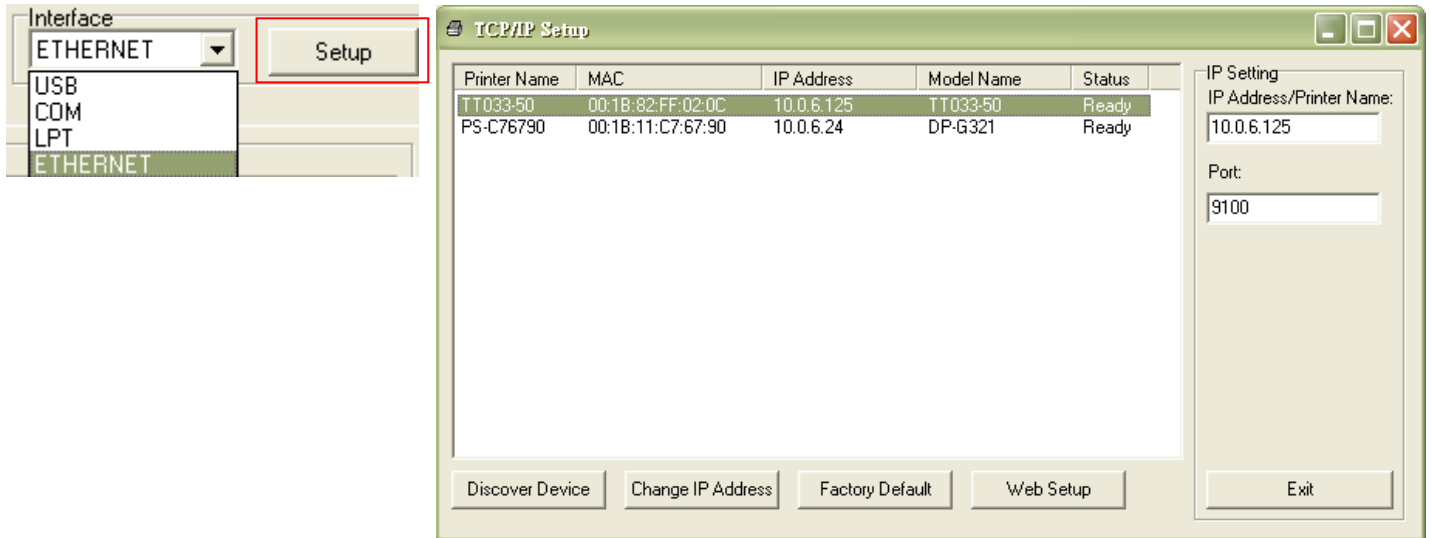

5. Click the “Discover Device” button to explore the printers that exist on the network.
6. Select the printer in the left side of listed printers, the correspondent IP address will be shown in the right side “IP address/Printer Name” field.
7. Click “Change IP Address” to configure the IP address obtained by DHCP or static.

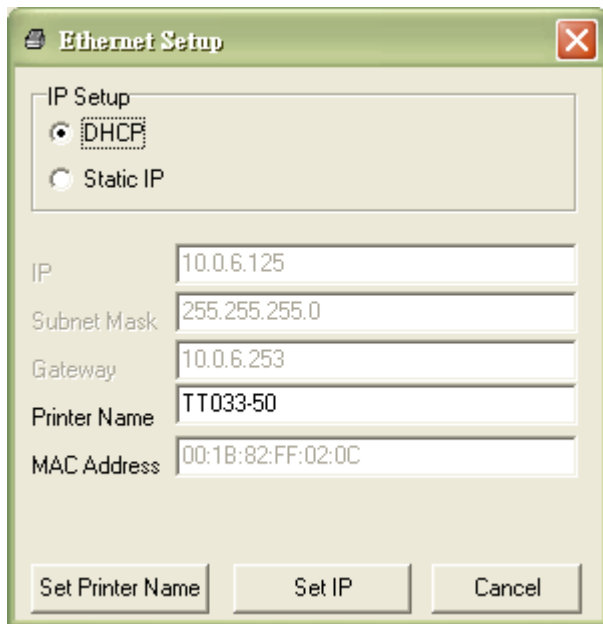

The default IP address is obtained by DHCP. To change the setting to static IP

address, click “Static IP” radio button then enter the IP address, subnet mask and gateway. Click “Set IP” to take effect the settings.

Users can also change the “Printer Name” by another model name in this fields then click “Set Printer Name” to take effect this change.

Note: After clicking the “Set Printer Name” or “Set IP” button, printer will reset to take effect the settings.

8. Click “Exit” button to exit the Ethernet interface setup and go back to Diagnostic Tool main screen.

Factory Default button

This function will reset the IP, subnet mask, gateway parameters obtained by DHCP and reset the printer name.

Web setup button

Except to use the Diagnostic Utility to setup the printer, you can also explore and configure the printer settings and status or update the firmware with the IE or Firefox web browser. This feature provides a user friendly setup interface and the capability to manage the printer remotely over a network.

6. Troubleshooting

6.1 Common Problems

The following guide lists the most common problems that may be encountered when operating this bar code printer. If the printer still does not function after all suggested solutions have been invoked, please contact the Customer Service Department of your purchased reseller or distributor for assistance.

Problem	Possible Cause	Recovery Procedure						
Power indicator does not illuminate	<ul style="list-style-type: none"> * The power cord is not properly connected. 	<ul style="list-style-type: none"> * Plug the power cord in printer and outlet. * Switch the printer on. 						
Carriage Open	<ul style="list-style-type: none"> * The printer carriage is open. 	<ul style="list-style-type: none"> * Please close the print carriage. 						
No Ribbon	<ul style="list-style-type: none"> * Running out of ribbon. * The ribbon is installed incorrectly. 	<ul style="list-style-type: none"> * Supply a new ribbon roll. * Please refer to the steps in user's manual to reinstall the ribbon. 						
No Paper	<ul style="list-style-type: none"> * Running out of label. * The label is installed incorrectly. * Gap/black-mark sensor is not calibrated. 	<ul style="list-style-type: none"> * Supply a new label roll. * Please refer to the steps in user's manual to reinstall the label roll. * Calibrate the gap/black-mark sensor. 						
Paper Jam	<ul style="list-style-type: none"> * Gap/black-mark sensor is not set properly. * Make sure label size is set properly. * Labels may be stuck inside the printer mechanism. 	<ul style="list-style-type: none"> * Calibrate the gap/black-mark sensor. * Set label size correctly. 						
<table border="1"> <tr> <td>UP:</td> <td>Fwd.</td> </tr> <tr> <td>DOWN:</td> <td>Rev.</td> </tr> <tr> <td>MENU:</td> <td>Exit</td> </tr> </table>	UP:	Fwd.	DOWN:	Rev.	MENU:	Exit	<ul style="list-style-type: none"> * Cutter jam. * There is no cutter installed on the printer. * Cutter PCB is damaged. 	<ul style="list-style-type: none"> * If the cutter module is installed, please press UP or DOWN key to rotate the cutter up or down to make the knife back to the right position. * Remove the label. * Make sure the thickness of label is less than 0.254 mm (10mil) * Replace a cutter PCB.
UP:	Fwd.							
DOWN:	Rev.							
MENU:	Exit							

<p>Not Printing</p>	<ul style="list-style-type: none"> * Cable is not well connected to serial or USB interface or parallel port. * The serial port cable pin configuration is not pin to pin connected. 	<ul style="list-style-type: none"> * Re-connect cable to interface. * If using serial cable, <ul style="list-style-type: none"> - Please replace the cable with pin to pin connected. - Check the baud rate setting. The default baud rate setting of printer is 9600,n,8,1. * If using the Ethernet cable, <ul style="list-style-type: none"> - Check if the Ethernet RJ-45 connector green LED is lit on.. - Check if the Ethernet RJ-45 connector amber LED is blinking. - Check if the printer gets the IP address when using DHCP mode. - Check if the IP address is correct when using the static IP address. - Wait a few seconds let the printer get the communication with the server then check the IP address setting again. * Chang a new cable. * Ribbon and media are not compatible. * Verify the ribbon-inked side. * Reload the ribbon again. * Clean the printhead. * The print density setting is incorrect. * Printhead's harness connector is not well connected with printhead. Turn off the printer and plug the connector again. * Check if the stepping motor is plugging in the right connector. * Check your program if there is a command PRINT at the end of the file and there must have CRLF at the end of each command line.
<p>Memory full (FLASH / DRAM)</p>	<ul style="list-style-type: none"> * The space of FLASH/DRAM is full. 	<ul style="list-style-type: none"> * Delete unused files in the FLASH/DRAM. * The max. numbers of file of DRAM is 256 files. * The max. user addressable memory space of DRAM is 2048 KB. * The max. numbers of file of FLASH is 256 files. * The max. user addressable memory space of FLASH is 6656KB.
<p>SD card is unable to use</p>	<ul style="list-style-type: none"> * SD card is damaged. * SD card doesn't insert correctly. * Use the non-approved SD card manufacturer. 	<ul style="list-style-type: none"> * Use the supported capacity SD card. * Insert the SD card again. * The supported SD card spec. <ul style="list-style-type: none"> - 128MB - 256MB - 512MB - 1GB - 4GB SDHC CLASS 6 * Approved SD card manufacturers; SanDisk, Transcend
<p>PS/2 port does not work</p>	<ul style="list-style-type: none"> * Did not turn off power prior to plug in the PS/2 keyboard. * PS/2 keyboard is damaged. * PS/2 keyboard doesn't plug-in correctly. * There is no BAS file in the printer. 	<ul style="list-style-type: none"> * Turn off printer power prior to plug in the PS/2 keyboard . * Plug the PS/2 keyboard again. * Make sure the keyboard is fine. * Make sure if there is any BAS file downloaded into printer.

Poor Print Quality	<ul style="list-style-type: none"> * Ribbon and media is loaded incorrectly * Dust or adhesive accumulation on the printhead. * Print density is not set properly. * Printhead element is damaged. * Ribbon and media are incompatible. * The printhead pressure is not set properly. 	<ul style="list-style-type: none"> * Reload the supply. * Clean the printhead. * Clean the platen roller. * Adjust the print density and print speed. * Run printer self-test and check the printhead test pattern if there is dot missing in the pattern. * Change proper ribbon or proper label media. * The release lever does not latch the printhead properly.
LCD panel is dark and keys are not working	<ul style="list-style-type: none"> * The cable between main PCB and LCD panel is loose. 	<ul style="list-style-type: none"> * Check if the cable between main PCB and LCD is secured or not.
LCD panel is dark but the LEDs are light	<ul style="list-style-type: none"> * The printer initialization is unsuccessful. 	<ul style="list-style-type: none"> * Turn OFF and ON the printer again. * Initialize the printer.
LCD panel is dark and LEDs are lit on, but the label is feeding forward	<ul style="list-style-type: none"> * The LCD panel harness connector is loose. 	<ul style="list-style-type: none"> * The LCD panel harness connector is plugged upside down.
Ribbon encoder sensor doesn't work	<ul style="list-style-type: none"> * The ribbon encoder sensor connector is loose. 	<ul style="list-style-type: none"> * Fasten the connector.
Ribbon end sensor doesn't work	<ul style="list-style-type: none"> * The connector is loose. * The ribbon sensor hole is covered with dust. 	<ul style="list-style-type: none"> * Check the connector. * Clear the dust in the sensor hole by the blower.
Cutter is not working	<ul style="list-style-type: none"> * The connector is loose. 	<ul style="list-style-type: none"> * Plug in the connect cable correctly.
Label feeding is not stable (skew) when printing	<ul style="list-style-type: none"> * The media guide does not touch the edge of the media. 	<ul style="list-style-type: none"> * If the label is moving to the right side, please move the label guide to left. * If the label is moving to the left side, please move the label guide to right.
Skip labels when printing	<ul style="list-style-type: none"> * Label size is not specified properly. * Sensor sensitivity is not set properly. * The media sensor is covered with dust. 	<ul style="list-style-type: none"> * Check if label size is setup correctly. * Calibrate the sensor by Auto Gap or Manual Gap options. * Clear the GAP/Black-mark sensor by blower.
The left side printout position is incorrect	<ul style="list-style-type: none"> * Wrong label size setup. * The parameter Shift X in LCD menu is incorrect. 	<ul style="list-style-type: none"> * Set the correct label size. * Press [MENU] → [SELECT] x 3 → [DOWN] x 5 → [SELECT] to fine tune the parameter of Shift X.
Missing printing on the left or right side of label	<ul style="list-style-type: none"> * Wrong label size setup. 	<ul style="list-style-type: none"> * Set the correct label size.
RTC time is incorrect when reboot the printer	<ul style="list-style-type: none"> * The battery has run down. 	<ul style="list-style-type: none"> * Check if there is a battery on the main board.
Multi interface board doesn't work	<ul style="list-style-type: none"> * The installation is incorrect. 	<ul style="list-style-type: none"> * Check if the board is plugged in the right connector.
Power and Error LEDs are blinking fast	<ul style="list-style-type: none"> * Power switch OFF and ON too fast. 	<ul style="list-style-type: none"> * Turn off the printer and wait all LEDs are dark, and turn on the printer again.

Wrinkle Problem	<ul style="list-style-type: none"> * Printhead pressure is incorrect. * Ribbon installation is incorrect. * Media installation is incorrect. * Print density is incorrect. * Media feeding is incorrect. 	<ul style="list-style-type: none"> * Make sure the label guide touch the edge of the media guide. * Make sure label, paper core and ribbon are set at the center of the spindle.
Gray line on the blank label	<ul style="list-style-type: none"> * The printhead is dirty. * The platen roller is dirty. 	<ul style="list-style-type: none"> * Clean the printhead. * Clean the platen roller.
Irregular printing	<ul style="list-style-type: none"> * The printer is in Hex Dump mode. * The RS-232 setting is incorrect. 	<ul style="list-style-type: none"> * Turn off and on the printer to skip the dump mode. * Re-set the Rs-232 setting.

6.2 Mechanism Fine Adjustment to Avoid Ribbon Wrinkles

This printer has been fully tested before delivery. There should be no ribbon wrinkle presented on the media for general-purpose printing application. Ribbon wrinkle is related to the media thickness, print head pressure balance, ribbon film characteristics, print darkness setting...etc. In case the ribbon wrinkle happens, please follow the instructions below to adjust the printer parts.

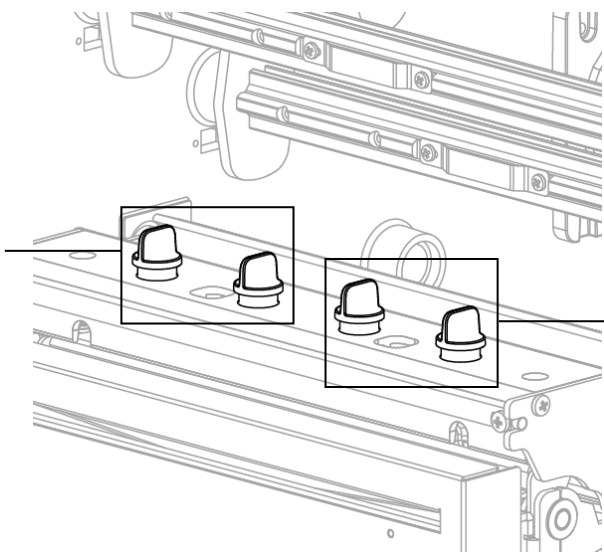
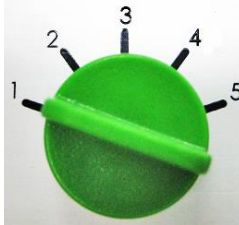
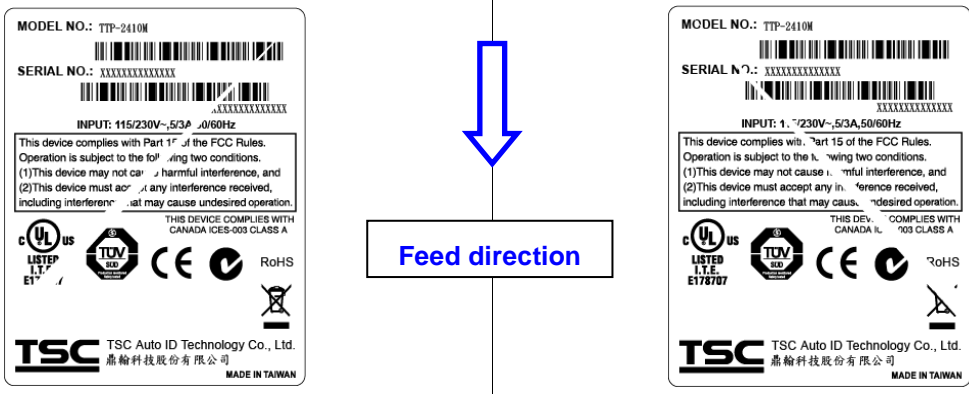
<p>Adjustable Printer Parts</p>		
		<p>There are 5 levels of print head pressure adjustment knob settings. The lowest pressure index is 1 and the highest pressure index is 5.</p>
<p>Symptom</p>	<p>1. Wrinkle happens from label lower left to upper right direction (" / ")</p>	<p>2. Wrinkle happens from label lower right to upper left direction (" \ ")</p>
<p>Wrinkle Example</p>		

Adjust the print head pressure adjustment knobs

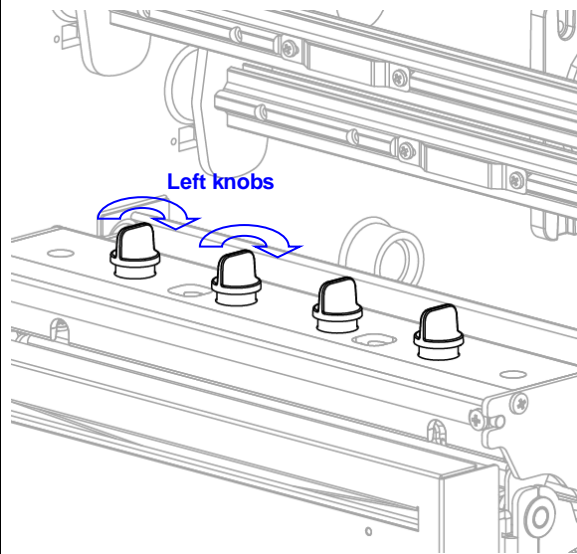

The print head pressure adjustment knob has 5 levels of settings. Clockwise direction adjustment is to increase the print head pressure. Counter Clockwise adjustment can decrease the print head pressure.

If the wrinkle on the label starts from the lower left side to upper right side, please do following adjustment.

1. Decrease the right side print head pressure adjustment knobs setting 1 level per each adjustment then print the label again to check if wrinkle is gone.
2. If the right side print head adjustment knobs setting has been set to index 1 (the lowest pressure index), please increase the left side print head pressure.

Adjust the print head pressure adjustment knobs

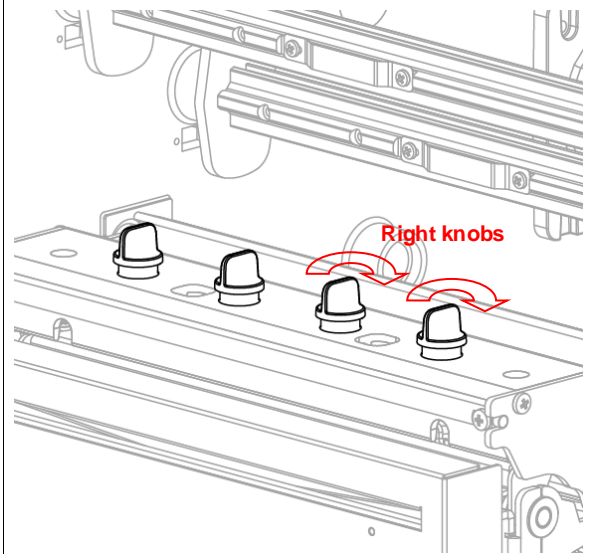

The print head pressure adjustment knob has 5 levels of settings. Clockwise direction adjustment is to increase the print head pressure. Counter Clockwise adjustment can decrease the print head pressure.

If the wrinkle on the label starts from the lower right side to upper left side, please do following adjustment.

1. Decrease the left side print head pressure adjustment knobs setting 1 level per each adjustment then print the label again to check if wrinkle is gone.
2. If the left side print head adjustment knobs level has been set to index 1 (the lowest index), please increase the right side print head pressure.

7. Maintenance

This session presents the clean tools and methods to maintain your printer.

1. Please use one of following material to clean the printer.

- Cotton swab (Head cleaner pen)
- Lint-free cloth
- Vacuum / Blower brush
- 100% ethanol

2. The cleaning process is described as following

Printer Part	Method	Interval
Printhead	1. Always turn off the printer before cleaning the printhead. 2. Allow the printhead to cool for a minimum of one minute. 3. Use a cotton swab (Head cleaner pen) and 100% ethanol to clean the printhead surface.	Clean the printhead when changing a new label roll
Platen Roller	1. Turn the power off. 2. Rotate the platen roller and wipe it thoroughly with 100% ethanol and a cotton swab, or lint-free cloth.	Clean the platen roller when changing a new label roll
Sensor	Compressed air or vacuum	Monthly
Exterior	Wipe it with water-dampened cloth	As needed
Interior	Brush or vacuum	As needed

Note:

- Do not touch printer head by hand. If you touch it careless, please use ethanol to clean it.

- Please use 100% Ethenol. DO NOT use medical alcohol, which may damage the printer head.
- Regularly clean the printhead and supply sensors once change a new ribbon to keep printer performance and extend printer life.

Revise History

Date	Content	Editor
2008/12/17	Revise troubleshooting section	Camille
2009/3/4	Revise 2.1 section (Add ribbon take up paper core)	Camille
2009/3/9	Revise recommended SD card specification list (2.2.3 section)	Camille
2009/3/23	Revise section 1.2	Camille
2009/4/7	Revise section 1.2	Camille
2009/6/19	Revise section 1.2 and 2.2.2	Camille
2009/6/25	Add 6.2 section (Mechanism fine adjustment to avoid ribbon wrinkles)	Camille
2009/10/16	-Revise section 4 -Add section 5	Camille
2010/11/23	Revise sections 1, 2.2.3 and 2.4	Camille
2011/1/25	Modify TSC address	Camille
2012/1/10	Revise section 2.6	Cinya
2013/4/1	Add TSC YouTube web address Add cutter module spec on section 2.6 Modify 3.3 for V7.0 FW self test	Camille
2013/9/18	Modify section 1.2	Camille
2014/11/5	Modify section 1.2	Camille



TSC Auto ID Technology Co., Ltd.

Corporate Headquarters
9F., No.95, Minguan Rd., Xindian Dist.,
New Taipei City 23141, Taiwan (R.O.C.)
TEL: +886-2-2218-6789
FAX: +886-2-2218-5678
Web site: www.tscprinters.com
E-mail: printer_sales@tscprinters.com
tech_support@tscprinters.com

Li Ze Plant
No.35, Sec. 2, Ligong 1st Rd., Wujie Township,
Yilan County 26841, Taiwan (R.O.C.)
TEL: +886-3-990-6677
FAX: +886-3-990-5577